

# वार्षिक प्रतिवेदन Annual Report 2017-18

**TRANSFORMING LIVELIHOOD THROUGH  
MISSION AROMA - THE GOLDEN WAY**



## संस्थान गान

हे हिमालय हम तेरे, हैं प्रबुद्ध अन्वेषी ।  
हे हिमालय हम तेरे, हैं प्रबुद्ध अन्वेषी ।  
जैव सम्पदा को तेरी, सुरक्षित करते जाएंगे ॥

प्रौद्योगिकी से हम तेरी, वैभवता बढ़ाएंगे ।  
अनुसंधान से जग में, अर्थ विकास करारेंगे ।  
अर्थ विकास करारेंगे ॥

हिम आचल में तेरे, प्रगति कर दिखलायेंगे ।  
ज्ञान से अज्ञान तिमिर, हम मिटाते जाएंगे ।  
हम मिटाते जाएंगे ॥

हो समर्पित हम सभी, जन उत्थान करारेंगे ।  
हे हिमालय हम तुझे, भव्य बनाते जाएंगे ॥

भव्य बनाते जाएंगे  
भव्य बनाते जाएंगे

संस्थान गान हेतु  
क्यूआर कोड को स्कैन करें  
क्यूआर रीडर ऐप  
डाउनलोड करें



Scan QR Code  
for Institute's song  
Download a QR  
reader app

[https://www.youtube.com/watch?v=ZOH-\\_oXN3T0](https://www.youtube.com/watch?v=ZOH-_oXN3T0)

ISSN - 0971 - 8842

# Annual Report 2017-18

*With Best Compliments from*

*Dr. Sanjay Kumar*

*Director*



**CSIR- Institute of Himalayan Bioresource Technology  
Palampur (H.P.)-176061**

© Director, CSIR-IHBT, Palampur (H.P.)

**Published by** : Dr. Sanjay Kumar  
CSIR- Institute of Himalayan Bioresource Technology  
Palampur (H.P.)-176061, India.  
Phone: +91-1894-230411, Fax: +91-1894-230433  
Email: director@ihbt.res.in; Web: <http://ihbt.res.in>

**Editorial Committee** : Dr. Amita Bhattacharya, Dr. Vipin Hallan,  
Dr. Sanjay K. Uniyal, Dr. Gireesh Nadda, Dr. Ravi Shankar,  
Dr. Rituraj Purohit, Dr. S.K. Maurya,  
Dr. SGE Reddy, Dr. Vikram Patial, Dr. Ashish R. Warghat,  
Dr. Avnesh Kumari, Sh. Sanjay Kumar,  
Sh. Mukhtiar Singh

Technical Support : Sh. Saurabh Sharma  
Photograph and cover design : Sh. Pabitra Gain

# CONTENTS

Overview of CSIR-IHBT	:	iii
Organizational structure	:	iv
Research Council	:	v
Management Council	:	vii
Impressions	:	ix
Director's Report	:	xi
Major Highlights	:	xix
Technologies Available with CSIR-IHBT	:	xxv
CSIR-IHBT Technologies Rolled Out	:	xxxix
Mission Mode Projects	:	1
CSIR Mission Aroma	:	3
CSIR-Phytopharmaceutical Mission	:	16
CSIR-Fast Track Translational Project	:	21
Survey, Mapping, Characterization and Management of Himalayan Bioresources	:	25
Conservation of Rare, Endangered and Threatened Plant Species	:	35
Bioprospection and Characterization of Himalayan Bioresources	:	47
Centre for High Altitude Biology (CeHAB)	:	57
Chemical Technology	:	63
Health Science	:	83
Food & Nutraceuticals	:	91
High Value Crops	:	101
Crop Protection	:	133
CSIR Skill Development Programs	:	143
Incubation Centre at CSIR-IHBT	:	147
AcSIR-IHBT	:	153
Important Events	:	159
Business Development and Marketing Unit	:	173
राजभाषा गतिविधियाँ	:	177

Support Services	:	181
Planning, Project Monitoring and Evaluation	:	183
Engineering Service Unit	:	185
Administration	:	187
Finance and Accounts	:	188
Stores & Purchase	:	189
Computer Section	:	190
Library	:	190
Publications		193
Intellectual Property		195
Thesis/Dissertations/Report	:	204
Trainings	:	204
Conference/Training/Workshop/Symposium Presentations	:	206
Conference/Training/Workshop/Symposium Attended	:	206
Conference/Training/Workshop/Meeting Organized	:	209
Invited Lectures	:	211
Visits Abroad	:	212
Distinguished Visitors	:	212
Poster Presented	:	213
Prizes/Awards/Recognitions	:	214
Staffs	:	215
New Clippings of CSIR-IHBT	:	225

# OVERVIEW OF CSIR-IHBT

## Vision

To be a global leader on technologies for boosting bioeconomy through sustainable utilization of Himalayan bioresources

## Mission

To discover, develop and commercialize processes and products from Himalayan bioresources using cutting-edge science and technology

CSIR-Institute of Himalayan Bioresource Technology (CSIR-IHBT), perched in the lap of majestic snow clad mountains of Dhauladhar range in the western Himalaya, has a history that dates back to 1960s when CSIR proposed to set up a National Biological Research Institute at Palampur in H.P. The state government at that time made available 1225 acres of land for this establishment. This could not materialize and the matter remained undecided for 18 years. In the mean time, major portion of the allocated land paved way for the establishment of H.P. Agricultural University (now CSK HPKV) and other organisations. Subsequently, CSIR Regional Research Laboratory (RRL), Jammu also opened a Regional Research Centre at Palampur in a rented building to make a base for setting up of the proposed CSIR institute. The then Director of RRL, Jammu played a vital role in this matter and took possession of the remaining 226.1 acres of land in 1978. Subsequently, the then Chief Minister of H.P. formally requested Prof. Nurul Hasan, the Vice President of CSIR during that period to initiate the process and give a final shape to the proposal of setting up a CSIR institute. Finally, the foundation stone of CSIR Complex Palampur was laid on July 2, 1983 and the first Coordinating Director was appointed in February, 1984. Since then, the institute has been relentlessly working towards the development of technologies for sustainable utilization of Himalayan bioresources and societal upliftment. Based on the mandate of the institute and the milestones achieved, CSIR Complex, Palampur was rechristened as the institute of Himalayan Bioresource Technology in 1997. Further, to catalyze the economy of the high mountains through technological interventions, a Centre for High Altitude Biology (CeHAB) was established at Ribling (3450 m amsl, near Keylong), district Lahaul & Spiti, H.P. on October 1, 2012.

The institute is involved in harnessing and sustainable utilization of Himalayan bioresources through multifaceted state-of-the-art facilities for basic as well as translational research to develop end-to-end processes and products. The institute has a strong patent portfolio based on cutting edge science and vast experience of successful commercialization of technologies for propelling industrial growth. The institute has proven credentials in boosting economy through empowerment and enhancing livelihood of tribal and other communities of high altitude areas through floriculture, cultivation of medicinal & aromatic plants and processing of local resources for value addition.

## ORGANIZATIONAL STRUCTURE



### CSIR- Institute of Himalayan Bioresource Technology

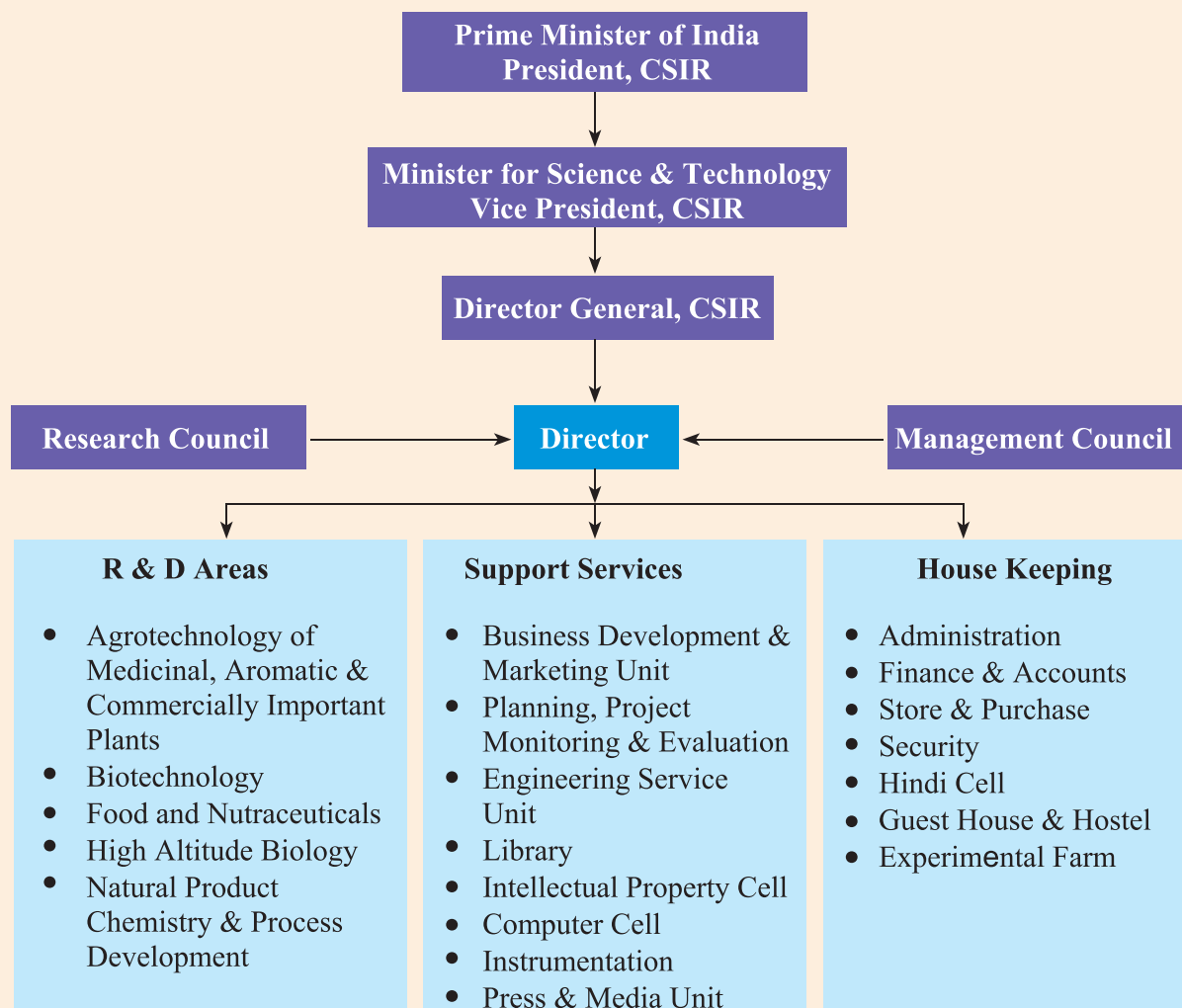



## RESEARCH COUNCIL



**Dr. Anil Kush, Chairman**

Chief Executive Officer  
Vittal Mallya Scientific Research Foundation,  
#23, 5th Main, J.C. Industrial Layout,  
Kanakapura Road,  
Bangalore - 560062

### Members



**Sh. Anand Chordia**

Director (Technical)  
Pravin Masalewale, 44,  
Hadapsar Industrial Estate,  
Hadapsar, Pune-411013  
Maharashtra (India)



**Dr. Amarinder Singh Bawa**

Former Director, DFRL  
103, Begonia,  
Sankalp Central Park,  
Main Road Jawa, Yadavgi,gi,  
Mysore - 570020, Karnataka



**Prof. Alok Bhattacharya**

Professor  
School of Life Sciences,  
Jawaharlal Nehru  
University,  
New Delhi-110067



**Dr. Anup Karwa**

Director Life Sciences  
Krishidhan Seeds Pvt Ltd,  
Jalna (Maharashtra)



**Dr. Ramesh V Sonti**

Director  
National Institute of Plant  
Genome Research,  
Aruna Asaf Ali Marg,  
P.O. Box No. 10531,  
New Delhi-110067



**Dr. Saroj K Barik**

Director  
CSIR-National Botanical  
Research Institute,  
Rana Pratap Marg,  
Post Box No. 436,  
Lucknow - 226001



**Dr. Sanjay Kumar**

Director  
CSIR-Institute of  
Himalayan Bioresource  
Technology,  
Post Box 6,  
Palampur-176061



## MANAGEMENT COUNCIL



**Dr. Sanjay Kumar, Chairman**  
Director  
CSIR-Institute of Himalayan Bioresource Technology,  
Palampur-176061 (H.P.)

### Members



**Dr. Anil Koul**  
Director  
CSIR-Institute of Microbial  
Technology,  
Chandigarh



**Dr. R.K. Sud**  
Sr. Principal. Scientist  
CSIR-Institute of  
Himalayan Bioresource  
Technology,  
Palampur- H.P.



**Er. Amit Kumar**  
Principal Scientist  
CSIR-Institute of  
Himalayan Bioresource  
Technology,  
Palampur (H.P.)



**Dr. Shashi Bhushan**  
Senior Scientist  
CSIR-Institute of  
Himalayan Bioresource  
Technology,  
Palampur (H.P.)



**Dr. Yogendra S. Padwad**  
Scientist  
CSIR-Institute of  
Himalayan Bioresource  
Technology,  
Palampur (H.P.)



**Sh. Mukhtiar Singh**  
Principal Technical Officer  
CSIR-Institute of  
Himalayan Bioresource  
Technology,  
Palampur- H.P.



**Dr. Sukhjinder Singh**  
Sr. Technical Officer(3)  
CSIR-Institute of  
Himalayan Bioresource  
Technology,  
Palampur (H.P.)

Finance & Account Officer  
CSIR-Institute of  
Himalayan Bioresource  
Technology, Palampur- H.P.



**Sh. Alok Sharma**  
Member Secretary  
Administrative Officer  
CSIR-Institute of  
Himalayan Bioresource  
Technology,  
Palampur- H.P.



## IMPRESSIONS

**Mrs. Renuka Chowdhury**, Member Parliament and Chairperson Parliament Standing Committee of Science and Technology, Govt. of India, “CSIR-IHBT” is an institute which is critical to the future of this sensitive Himalayan region. The wonderful work that is being done and more importantly, hand holding for the local farmers goes a long way in building bridges between lab and field & sustainable livelihood, Keep up the good work. More strength to your elbow.” - dated 23.06.2017.

**Mr. Ronald Sapa Tlau**, Member Parliament, “It was a great pleasure to be back in IHBT after two years. I can honestly say that my colleague, the MP’s led by my chairperson, were all so thrilled and excited to learn all the activities of the CSIR-IHBT scientists in various fields of research. The people of India & world will be so hugely benefited by your work. I wish you all the best and congratulate you for your achievements.”- dated 22.06.2017.

**Dr. Ram Lal Markanda**, Agriculture, IT and Tribal Development Minister, “Wonderful! really doing practical work and I am very happy to see their work in field and I hope they will prove practically extreme to the very prosperity.” - dated 29.01.2018.

**Dr. Anil Kush**, Chairman, Research Council, “Absolute delight to be in CSIR-IHBT again a-refreshing ambiance of innovation and knowledge generation. A team of committed and dedicated scientists. The Himalaya, hospitability, Himachali Dham, would take very long time to dilute from my memory. Wish the very best to team here and specially their leader! Bravo!” - dated 25.11.2017.



## FROM THE DIRECTOR'S DESK



It gives me immense pleasure to present the annual report of CSIR-IHBT for the year 2017-18. Based on our research performance, innovation outputs and societal impact, CSIR-IHBT made an entry in the SCImago Institutional Rankings for the first time within top 30 institutes of CSIR, attaining 9th place.

Following our mission to be a global leader on technologies to boost bioeconomy, and to achieve sustainable development goals as outlined by the Government of India, the institute initiated various mission mode, translational, focused basic research and niche creating projects in the areas of phytopharmaceuticals, aroma, food and nutraceuticals, feed, fibre, colours, dyes, and Himalayan environment.

Continuing endeavor to bio-prospect the vast microbial wealth in the Himalayas, several psychrotrophic bacterial strains were isolated which degrade organic waste, act as probiotics, and have utility in bioplastic and colour production. An efficient L-asparaginase enzyme, functional across a wide temperature range with no glutaminase activity, was discovered from Himalayan microbial source. Gene for asparaginase was cloned and successfully expressed in the *E. coli* to obtain higher yield. The purified enzyme was evaluated in normal and cancerous cell-lines and desired results with high cytotoxic potential were obtained. Enzyme bioprospection from bacteria of high altitude regions of Himalayas identified an efficient cellulase that was functional across a broad pH and temperature range. This has potential to be used for chemical pretreatment processes of cellulosic biomass valorization.

In the area of enzyme prospection, codons of *polyphenol oxidase (PPO)* of tea were optimized for expression in *E. coli* and a synthetic *PPO* was successfully expressed in *E. coli* that exhibited tea-PPO activity. This provided an opportunity for upscaled production of PPO in a bioreactor without depending on tea leaves for the enzyme for production of theaflavins/thearubigins.

Participation of the institute in “Phytopharmaceutical Mission” of CSIR was a step forward towards conservation and sustainable utilization of medicinal plants including rare, endangered and threatened (RET) plant species. During this period, about three crores planting material was generated for *Stevia rebaudiana*, *Valeriana jatamansi* and *Inula racemosa*. This brought several hectares of land under captive cultivation across India.

Natural populations of high value medicinal orchid *Dactylorhiza hatagirea*, harvested indiscriminately from wild for its tubers, was studied to understand its survival strategies. Studies suggested that the persistence of remnant populations is high and the species has capability to recover rapidly if conservation measures are taken in time.

During the period, 701 accessions of 48 populations representing wider geographical distribution of RET species were included in the gene bank. About 5000 microsatellite markers were identified and validated in selected random genotypes of *Sinopodophyllum hexandrum* and *Picrorhiza kurrooa*. Diversity characterization revealed that these population captured moderate to high level of genetic diversity.

In yet another mission mode program of CSIR “Mission Aroma”, a new initiative was taken whereby large stretches of barren and/or under-utilized lands were targeted for production of aromatic crops. During the first phase, an area of about 120 ha was brought under cultivation of *Tagetes minuta* (wild marigold) using our improved variety “Himgold” and about 3.5 tons of wild marigold oil was

produced that benefitted 560 farmers. This enhanced the farmer's income by 2-3 times as compared to the traditional crops like wheat/rice. Agro- and processing-technologies for other aromatic crops such as lemongrass and lavender was also extended in the region.

To further supplement income of farmers engaged in medicinal and aromatic crops, bee-keeping was demonstrated to produce quality honey and promote pollination for increased production. A prototype of improved "Flow Hive" is being developed in association with CSIR-CSIO for efficient harvesting of honey in a bee and beekeeper friendly mode.

Under the varietal improvement programme, a new variety of stevia (a low calorie sweetener) with minimal after taste was developed. Also, a green process technology for conversion of dry stevia leaf into ready to use liquid steviosides formulation has been developed at pilot scale. One incubatee has started developing and marketing the product as a sweetener for food and beverages. Significantly, stevia cultivation was introduced in Bastar region of Chhattisgarh to improve livelihood of the tribal community.

Advancing in the area of natural low calorie sweeteners, monk fruit (*Siraitia grosvenorii*) was introduced in the country for the first time with due approval from ICAR-National Bureau of Plant Genetic Resources (NBPGR), New Delhi (Import Permit No. 168/2017). The plant produces an intense sweet tasting, near to zero calorie mogrosides, which are a group of cucurbitane-type triterpene glycosides. The species is being grown in our farm under the vigil of ICAR-NBPGR, New Delhi.

The institute forged ahead to strengthen its ties with the north-eastern region of the country. Inspired by the success of low chilling apple varieties introduced in Champhai district of Mizoram, North-East Council, in association with our institute, is expanding apple cultivation in the selected north-eastern states.

With an aim to generate disease free corms of requisite weight ( $\geq 10$  g) of saffron, agro-techniques were standardized that increased the weight from 8 g to about 20 g in one season. Saffron cultivation was also extended in non-traditional areas of Himachal Pradesh with success based upon the results of niche modeling.

Floriculture activity for cultivation of tulips, liliun, marigold, calla lilly and carnation were extended not only in several districts of Himachal Pradesh (HP), but also in Jammu & Kashmir, and Punjab with an aim to enhance income of the farmers. Hydro- and aero-ponic cultivation of tulips, rosemary, iceberg lettuce, cherry tomato and *V. jatamansi* were standardized. Hydroponic cultivation reduced the flowering time from 90 to 30 days in tulips.

Rising indoor air pollution levels has raised concern regarding human health and ways to control it using plants is being emphasized. Our study on Areca Palm showed reduction in volatile organic compounds and hence is worth an indoor plant species.

Based upon institute's capability in the area of remote sensing, forest fire susceptibility maps for Kangra District were developed using geospatial techniques which is now included in District Disaster Management Action Plan report 2017 of Government of Himachal Pradesh.

While scientists all over the world are seeking to improve photosynthesis in crop plants to enhance yield, through introduction of  $C_4$ -like traits in to  $C_3$  plants, our group reported a novel mechanism to do so through re-fixation of  $CO_2$  and  $NH_3$  generated during the process of photorespiration. Our work on heterologous co-expression of three enzymes phosphoenolpyruvate carboxylase, aspartate aminotransferase and glutamine synthetase demonstrated improved re-assimilation of photorespired  $CO_2$  and  $NH_3$  with concomitant increase in growth, biomass and yield in transgenic *Arabidopsis thaliana*, a  $C_3$  plant.



Genome wide transcriptome sequencing coupled with co-expression network analyses elucidated nitrate mediated molecular mechanism of nitrogen use efficiency (NUE) in *Brassica juncea*. Twenty eight genes involved in nitrogen transport assimilation and remobilization were identified that regulate NUE via phenylpropanoid biosynthesis, carbon and nitrogen interaction and nitrate reductase activity. To enhance the yield potential and implementation of marker-aided selection, global transcriptional analysis identified genome wide molecular markers and key enzymes in *Stevia rebaudiana*.

In the area of plant pathogen interaction, AV2 and AC4 proteins were identified as suppressor of silencing encoded by tomato leaf curl virus. These proteins interact with catalase 2 of host to facilitate virus infection.

With an aim to develop nutritional food supplements, local ingredients such as millets, pulses, cereals, buckwheat, nuts and fruits were used for developing ready to eat and ready to reconstitute nutritious food products, such as energy bars, protein-micronutrient fortified bars, fruit bars, instant protein-energy rich premixes, and herbal *Khichadi*. These products are free from synthetic preservatives, additives, high fructose corn syrup, artificial sweeteners, and can supplement up to 15% of daily recommended dietary allowances (RDA) of protein, dietary fiber, iron, zinc and calcium. The technologies for production of the above products were licensed to M/s Access India Impex Centre Pvt. Ltd., New Delhi, and Dexter Retail Distribution Pvt. Ltd., New Delhi.

Ligno-cellulosic biomass is a major bioresources wealth in Himalayas. Renewable bioresources, such as bamboo species, weeds and other residues were bioprospected for their conversion into high purity cellulose pulp. Studies conducted have shown promising results, and processes for converting cellulose into textile fiber and other related products are underway. A pilot scale process for 5-hydroxymethyl furfural synthesis has been developed and patented from different cellulosic biomass as a feedstock chemical for bio-fuel, bio-polymer and fine chemicals production.

Benzosuberenes are the important key structural motifs in various natural products such as terpene, alkaloids and pharmacologically active compounds and known for their anti-depressant antitumor activities. A semi-synthetic approach for the conversion of Himachalenes, fractionated from *Cedrus deodara* oil to pyrrolone-fused benzosuberenes synthesis was achieved for treatment of epilepsy and oral cancer.

During the year, a novel method for the synthesis of new quinolines derivatives *via* innovative remote C-H activation was developed. These molecules were found to be active in sub-micro molar concentration against malaria-causing strains. 2-Aminoquinazolin-4(3H)-one was developed as an organocatalyst for the reduction of nitroarenes and method was utilized for the synthesis of ciprofloxacin derivatives. Concomitantly, an iron (II)-catalyzed eco-friendly amination protocol was developed and extended to amination of phytol and ciprofloxacin.

Excessive use of hazardous and harmful synthetic dyes has evinced increased interest towards natural colours from sustainable bioresources. A green and cost-effective process for extraction of edible natural colours from various vegetable sources was developed. The colours so developed were non-hygroscopic, stable and in crystalline form.

With an aim to scientifically validate important traditional medicines, a major headway was made towards combating diabetes and epilepsy due to insulin deficiency. Standardised extracts of *P. kurroa* and *Ginkgo biloba* showed promising results in diabetes and temporal lobe epilepsy, respectively in preclinical trials. *P. kurroa* enhanced pancreatic  $\beta$ -cell regeneration and increased insulin secretion in diabetic rats with improvement in liver and kidney functions. *G. biloba* suppressed epileptic seizures associated behavioral and memory impairments via inhibition of mTOR (mammalian target of rapamycin) signaling pathway in the brain hippocampus. Further, potential of epigallocatechin

gallate was established as prebiotic in symbiotic functional food against ageing and age associated inflammatory disorders in preclinical model of aging mice.

Importantly, research scholars of the institute initiated a new activity to organize a one-day conference on 'Bioeconomy, Bioresources, Himalaya, Product and Processes' to foster scientific temperament and cross-fertilization of ideas between different scientific groups. This displayed their strengthened organizational skill to conduct such events, independently.

The institute invites and welcomes large number of students each year to visit its campus, laboratories and farms for educational purpose. This year, nearly 3,000 students from different schools, colleges/ universities from within and outside the state visited the institute under "Jigyasa" and other programs.

Strengthening of infrastructure and scientific analytic facilities are important to support and boost high quality research. Institute is now equipped with next/third generation sequencing platforms from Illumina and PacBio, metabolomic and proteomics platforms, aero- and hydro-ponics units, and a zebrafish experimentation facility. State of the art poly/green houses were developed during the year for strengthening farm activities. Construction work on the sabbatical homes and a community place, were successfully completed. Work was initiated to develop an incubation facility for food processing and to uplift the abandoned research farm at Bundla village. Several additional activities were taken-up for aesthetic and smooth functioning, that included extension of the bituminous road to climate change simulation studies site, widening of roads in the front of Blocks G and H and from gate number 2 to the guest-house, and plantation of trees, shrubs and hedges along road sides to improve campus landscape.

In order to promote industrial enterprise for youth of the nation and employment generation, Incubation Centre was developed in the institutes. Currently, 10 incubatees are working in the areas of food processing, tea, floriculture, aroma and e-marketing under the State CM Startup Scheme.

Our technologies and R&D activities were show-cased in various exhibitions and trade fairs across the country, including the India International Science Festival. For social outreach and connect, new linkages were developed and strengthened with line departments, business houses, and other agencies. Notably, 29 agreements/MoUs were signed with partners across the country for technology and/or material transfer. This is an important step not only to attain financial self- sufficiency, but also to benefit society and industry through science and technology.

Valuable advice from peers and esteemed Research and Management Councils, constant encouragement from CSIR headquarter, and financial support from CSIR and various funding agencies helped us to strive for scientific excellence and technological leadership for industrial, environmental and societal gains.

Jai Hind!



(Sanjay Kumar)

## निदेशकीय प्रतिवेदन

मुझे सीएसआईआर-हिमालय जैवसंपदा प्रौद्योगिकी संस्थान के वर्ष 2017-18 का वार्षिक प्रतिवेदन प्रस्तुत करते हुए अत्यन्त हर्ष हो रहा है। अपने शोध कार्य, नवोन्मेष उपलब्धियों और सामाजिक हितों के आधार पर सीएसआईआर-आईएचबीटी ने एससीइमेगो संस्थान रैंकिंग में सीएसआईआर के 30 शीर्ष संस्थानों में पहली बार प्रवेश पाया तथा 9वां स्थान प्राप्त किया।

जैव-आधारित आर्थिकी उन्नत करने के लिए प्रौद्योगिकियों के क्षेत्र में वैश्विक नेतृत्व प्रदान करने के हमारे लक्ष्य और भारत सरकार द्वारा निर्धारित सतत विकास लक्ष्यों को प्राप्त करने की दिशा में संस्थान ने फाइटोफार्मास्यूटिकल्स, संगंध, खाद्य एवं न्यूट्रास्यूटिकल, पोषण, रेशे, रंग एवं रंजक तथा हिमालयी पर्यावरण के क्षेत्र में आधारभूत शोध की विभिन्न मिशन मोड और ट्रांसलेशनल परियोजनाओं को शुरु किया है।

हिमालय में विस्तृत सूक्ष्मजीव (माइक्रोबियल) संपदा का पता लगाने के हमारे प्रयासों को आगे बढ़ाते हुए कई साइकोट्रोफिक जीवाणुरोधी उपभेदों का पता लगाया, जो जैविक अपशिष्ट को गलाने में सहायक हैं, प्रोबायोटिक के रूप में कार्य करते हैं और जिनकी बायोप्लास्टिक एवं रंग उत्पादन में उपयोगिता है। हिमालयी सूक्ष्मजीव (माइक्रोबियल) स्रोतों से ग्लूटामिनेस गतिविधि रहित एवं विस्तृत तापमान सीमा में कारगर एल-एस्पैराजिनेज एंजाइम की खोज की गई। एस्पैराजिनेज के लिए उत्तरदायी जीन को क्लोन किया और व्यापक मात्रा में फसल प्राप्त करने के लिए ई. कोलाई में सफलतापूर्वक अभिव्यक्त किया गया। शुद्ध एंजाइम का आकलन सामान्य और कैंसर कोशिका-रेखाओं में किया गया और उच्च साइटोटोक्सिक क्षमता के साथ अनुकूल परिणाम प्राप्त किए गए। हिमालय के ऊंचाई वाले क्षेत्रों के जीवाणुओं से एंजाइम बायोप्रोस्पेक्शन में एक प्रभावी सेल्यूलेज की पहचान की गई, जो व्यापक पीएच और तापमान में भी कार्य करता है। इसकी सेल्यूलोसिक बायोमास मूल्यवर्धन की रासायनिक पूर्व-उपचार प्रक्रियाओं में उपयोग की संभावना है।

इसी कड़ी में, एंजाइम प्रोस्पेक्शन के क्षेत्र में, चाय के पॉलीफेनॉल ऑक्सीडेस (पीपीओ) के कोडॉन्स को ई. कोलाई में अभिव्यक्ति के लिए अनुकूलित किया गया था तथा ई. कोलाई में सिंथेटिक पीपीओ को सफलतापूर्वक अभिव्यक्त किया, जिसने चाय-पीपीओ गतिविधि दिखाई दी। इससे चाय पत्तियों की निर्भरता के बिना थियारुबिजिनस/थियारुबिजिनस के उत्पादन हेतु एंजाइम के लिए बायोरिएक्टर में पीपीओ के उच्च मात्रा में उत्पादन हेतु एक अवसर है।

सीएसआईआर के 'फाइटोफार्मा मिशन' में संस्थान की प्रतिभागिता विशेषकर विरल, संकटग्रस्त और लुप्तप्राय (आरईटी) औषधीय पौधों के संरक्षण और दूरगामी उपयोग की दिशा में एक नया कदम रहा। इस अवधि के दौरान स्टीविया, वेलेरियाना जटामांसी और इनुला रेसीमोसा के तीन करोड़ पौधे तैयार किए गए। इससे भारत की कई हेक्टेयर भूमि को उपयोग में लाया गया।

मूल्यवान औषधीय ऑर्किड, डैक्टिलोराइज़ा हाटागिरेया जिनके कंदों का अत्याधिक दोहन किया जा रहा है, को बचाने के लिए उनके प्राकृतिक वासस्थानों में उपलब्धता का अध्ययन किया गया। अध्ययनों में पाया गया कि प्रकृति में इसकी उपलब्धता अच्छी है और समय पर संरक्षण उपाय किए जाएं तो यह तेजी से बढ़ सकती है।

इसके अतिरिक्त आरईटी प्रजातियों के पौधे की व्यापक भौगोलिक क्षेत्र का प्रतिनिधित्व करने वाली 48 प्रजातियों के 701 परिग्रहण जीन बैंक में शामिल किए गए। सिनोपोडोफिलम हेक्सेंड्रम और पिकोराइज़ा कुरुआ के चयनित यादृच्छिक जीनोटाइपों में लगभग 5000 माइक्रोसेटेलाइट मार्करों की पहचान और सत्यापन किया गया। विविधता विवेचन से ज्ञात हुआ कि इन जातियों ने मध्यम से उच्च स्तर की आनुवांशिक विविधता पर प्रदर्शित हुई।

सीएसआईआर के एक और मिशन मोड कार्यक्रम 'मिशन अरोमा' के अन्तर्गत एक नई पहल की गई, जिससे खाली पड़ी भूमि को संगंध फसलों के उत्पादन के लिए प्रयोग में गया। पहले चरण में लगभग 120 हेक्टेयर भूमि में संस्थान द्वारा विकसित जंगली गेंदे (टैजेटिस माइन्यूटा) की एक उन्नत किस्म 'हिमगोल्ड' का रोपण किया गया और लगभग

3.5 टन जंगली गेंदे के तेल का उत्पादन किया गया जिससे 560 किसानों को लाभ हुआ। गेहूँ, चावल जैसी पारंपरिक फसलों की तुलना में इससे किसान की आय 2-3 गुना बढ़ गई। लेमनग्रास और लेवेन्डर जैसी अन्य सुगंधित फसलों के लिए कृषि और प्रसंस्करण प्रौद्योगिकियों का भी विस्तार किया गया।

औषधीय और सुगंधित फसलों की खेती में लगे किसानों की अतिरिक्त आय के लिए गुणवत्ता युक्त शहद का उत्पादन बढ़ाने के लिए परागण को प्रोत्साहित करने के लिए मधुमक्खीपालन का प्रदर्शन किया गया। मधुमक्खी और मधुमक्खी पालकों के अनुकूल शहद को कुशलता से निकालने के लिए सीएसआईआर-सीएसआईओ के सहयोग से प्लो हाइव नामक एक प्रोटोटाइप विकसित किया गया है।

पादप किस्मों में सुधार पर कार्यक्रम के अन्तर्गत स्टीविया (कम कैलोरी युक्त स्वीटनर) की एक नई किस्म विकसित की गई। इसके अतिरिक्त सूखी स्टीविया पत्तियों को उपयोग के लिए तैयार तरल स्टीवियोसाइड में रूपांतरण के लिए एक हरित प्रक्रिया/प्रौद्योगिकी को पायलट स्केल पर विकसित किया गया है। एक इनक्यूबेटी ने खाद्य और पेय पदार्थों के लिए एक स्वीटनर के रूप में इसका उत्पादन एवं विपणन करना शुरू कर दिया है। उल्लेखनीय है छत्तीसगढ़ के बस्तर क्षेत्र में स्टीविया की खेती शुरू की गई है ताकि वहां के लोगों की आजीविका में सुधार हो।

प्राकृतिक रूप से कम कैलोरी युक्त स्वीटनर के क्षेत्र में आगे बढ़ते हुए मोंक फ्रूट (*सिरैरिया ग्रोसवेनोरी*) को आईसीएआर-नेशनल ब्यूरो ऑफ प्लांट जेनेटिक रिसोर्सेज (एनबीपीजीआर), नई दिल्ली (आयात परमिट सं.168/2017) के अनुमोदन के बाद पहली बार देश में लाया गया। यह पौधा लगभग शून्य कैलोरी मोग्रोसाइड मीठे स्वादयुक्त होता है, जो कि कुकरवितेन-प्रकार ट्राइटरपीन ग्लाइकोसाइड्स का एक समूह है। हमारे संस्थान में यह प्रजाति आईसीएआर-एनबीपीजीआर की निगरानी में उगाई जा रही है।

संस्थान देश के उत्तर-पूर्व राज्यों के साथ अपने संबंधों को मजबूत करने की दिशा में आगे बढ़ रहा है। संस्थान द्वारा मिजोरम के चम्फाई जिले में लगाई गई सेब की कम ठंडयुक्त क्षेत्र के लिए उपयुक्त किस्मों की सफलता से प्रेरित होकर उत्तर-पूर्व परिषद हमारे संस्थान के सहयोग से चयनित उत्तर-पूर्वी राज्यों में सेब की खेती का विस्तार कर रहा है।

केसर के वांछित भार (10ग्राम) के रोगमुक्त कॉर्म उत्पन्न करने के उद्देश्य से कृषि-तकनीक का मानकीकरण किया गया जिससे एक ऋतु में कॉर्म का भार 8 ग्राम से बढ़कर 20 ग्राम हो गया। मॉडलिंग परिणामों की सफलता के आधार पर हिमाचल प्रदेश के गैर पारंपरिक क्षेत्रों में केसर की खेती का विस्तार किया गया।

किसानों की आय बढ़ाने के उद्देश्य से संस्थान ने न केवल हिमाचल प्रदेश के कई जिलों में, अपितु जम्मू-कश्मीर और पंजाब में भी ट्यूलिप, लिलियम, गेंदा, कैला लिली और कार्नेशन की खेती को बढ़ाया। ट्यूलिप, रोसमेरी, आइसवर्ग लेट्यूस, चेरी टमाटर और *वैलेरियाना जटामांसी* की हाइड्रो और एयरो-पोनिक खेती को मानकीकृत कर लिया गया है। हाइड्रोपोनिक खेती ने ट्यूलिप के पुष्पन काल को 90 दिन से घटाकर 30 दिन कर दिया।

बढ़ते आंतरिक वायु प्रदूषण से मानव स्वास्थ्य पर पड़ने वाले कुप्रभाव ने सोने के लिए विवश कर दिया है और पौधों के द्वारा इसे नियंत्रित करने पर बल दिया जा रहा है। एरिका पॉम पर हमारे अध्ययन से इसमें वाष्पशील जैविक/कार्बनिक यौगिकों की कमी ज्ञात हुई। अतः यह पौधा घरों में लगाने के उपयुक्त है।

सुदूर संवेदन (रिमोट सेंसिंग) के क्षेत्र में संस्थान की क्षमता के आधार पर भूगर्भीय तकनीकों का उपयोग करके कांगड़ा जिले के लिए वन अग्नि के प्रति संवेदनशील क्षेत्रों के मानचित्रों को विकसित किया गया, जिन्हें अब हिमाचल प्रदेश सरकार के जिला आपदा प्रबंधन कार्य योजना रिपोर्ट 2017 में शामिल किया गया है।

समस्त विश्व के वैज्ञानिक  $C_3$  पौधों में  $C_4$  जैसे ट्रेट के प्रवेश द्वारा कृषि उत्पादन को बढ़ाने के लिए पौधों में प्रकाश संश्लेषण (Photosynthesis) में सुधार करने के लिए प्रयासरत हैं। हमारे समूह द्वारा प्रकाशीय श्वसन (फोटोरेस्पिरेशन) की प्रक्रिया से निकली  $CO_2$  और  $NH_3$  को पुनः सम्मिलित करके फसल में सुधार के लिए एक नया उपाय खोजा है। phosphoenolpyruvate carboxylase, aspartate aminotransferase और glutamine synthetase जैसे तीन एन्जाइमों के हेटरोलोगस सह-अभिव्यक्ति पर हमारे कार्य में ट्रांसजेनिक एरॉबिडोप्सिस ( $C_3$  पौधा) में प्रकाशीय श्वसन

की प्रक्रिया से निकली CO<sub>2</sub> और NH<sub>3</sub> को पुनः रोपित करने में सुधार हुआ तथा बायोमास और बीज उपज में वृद्धि हुई।

जीनोम ट्रांसक्रिप्टोम सिक्वेंसिंग और जीनस के नेटवर्क विश्लेषण द्वारा ब्रासिका जंसिया *Brassica juncea* में नाइट्रोजन उपयोग क्षमता (NUE) में नाइट्रेट मध्यस्थित आणविक प्रक्रिया को स्पष्ट किया गया। नाइट्रोजन के एसिमिलेशन और रीमोबिलाइजेशन में शामिल 28 जीन्स की पहचान की गई जो फेनिलप्रोपेनोइड बायोसिंथेसिस, कार्बन और नाइट्रोजन इंटरैक्शन और नाइट्रेट रेडक्टेज की गतिविधि के माध्यम से NUE को नियंत्रित करते हैं। उपज क्षमता बढ़ाने और मार्कर-एडेड चयन के कार्यान्वयन के लिए, ग्लोबल ट्रांसक्रिप्शनल विश्लेषण से स्टीविया रेबॉडियाना में जीनोम वाइड मॉलिक्यूलर मार्करों और प्रमुख एंजाइमों की पहचान की।

पौधों के रोगजनक के क्षेत्र में यह सत्यापित किया गया कि एवी 2 और एसी 4 प्रोटीन पौधे की प्रतिरक्षा प्रणाली के रोधक हैं। ये पौधों में उपलब्ध प्रोटीन 'कैटालेस 2' से मिलकर विषाणु संक्रमण में सहायता करते हैं।

पौष्टिक आहार विकसित करने के उद्देश्य से बाजरा, दालें, अनाज, बककड़ी, नट और फल जैसे स्थानीय सामग्री का उपयोग रेडी टू ईट और पौष्टिक खाद्य उत्पादों का निर्माण करने के लिए किया गया, जिनमें एनर्जी बार, प्रोटीन-माइक्रोन्यूट्रिएंट फोर्टिफाइड बार, फ्रूट बार, इंस्टेंट प्रोटीन एनर्जी मिक्स और हर्बल खिचड़ी शामिल हैं। ये उत्पाद सिन्थेटिक प्रिजरवेटिव, एडिटिव, हाई फ्रूक्टोज कॉर्न सिरप और कृत्रिम स्वीटनर से मुक्त हैं और यह उत्पाद प्रोटीन, डायटरी फाइबर, आयरन, जिंक और कैल्सियम की 15% (आरडीए) की प्रतिपूर्ति कर सकते हैं। उपरोक्त के उत्पादन के लिए मै. एक्सेस इंडिया इम्पेक्स सेंटर प्रा. लिमिटेड, नई दिल्ली और डेक्सटर रिटेल डिस्ट्रीब्यूशन प्रा. लिमिटेड, नई दिल्ली को लाइसेंस प्रदान किया।

लिंग्ना-सेल्यूलोसिक बायोमास हिमालय जैव संसाधनों की एक अन्य जैवसंपदा है। नवीनीकरण के लिए उपयुक्त जैवसंसाधनों जैसे बांस की प्रजातियां, खरपतवार और अन्य अवशेषों को उच्च शुद्धतायुक्त सेल्यूलोज लुगदी में उनके रूपांतरण के लिए जैवप्रत्याशित(बायोप्रोस्पेक्ट) किया गया। अब तक किए गए अध्ययनों से सकारात्मक परिणाम दिखाई दिए हैं और सेल्यूलोज को कपड़ा, रेशा और अन्य संबंधित उत्पादों में बदलने के लिए शोध चल रहा है। जैव-ईंधन, बायो-पॉलिमर और उत्तम रसायनों के उत्पादन के लिए फीडस्टॉक रसायन के रूप में विभिन्न सेल्यूलोसिक बायोमास से 5-हाइड्रोक्सीमिथाइल फरफुरल संश्लेषण के लिए एक व्यापक स्तर पर प्रक्रिया विकसित और पेटेंट की गई है।

टेरपीन एल्कोलोइड और फार्माकोलॉजिकल सक्रिय यौगिकों जैसे विभिन्न प्राकृतिक उत्पादों में वेंजोसुवेरेन एक महत्वपूर्ण संरचनात्मक रूप है और यह एंटी-डिप्रेंसेंट एंटीट्यूमर गतिविधियों के लिए जाने जाते हैं। सिड्रस दियोदारा तेल हिमाचलिनस से पिरॉलोन-फ्यूज्ड बेंजोसेबेरेन संश्लेषण प्राप्त करने के लिए परिवर्तित के अर्द्ध कृत्रिम उपाय को विकसित किया गया जो कि मिर्गी और मुख कैंसर के उपचार के लिए उपयोगी है।

इस वर्ष अभिनव रिमोट सी-एच सक्रियण के माध्यम से नए क्विनोलिन डेरिवेटिव के संश्लेषण के लिए एक नवीन कृत्रिम सिंथेटिक विधि विकसित की है। ये संश्लेषित अणु मलेरिया के कारण उपभेदों के विरुद्ध उप सूक्ष्म मोलर में सक्रिय पाए गए। 2-एमनोक्विनाजोलिन-3(3 एच) को एक कार्बनिक उत्प्रेरक के रूप में नोइट्रएरिन के कम करने के लिए विकसित किया गया और इस विधि का उपयोग सिप्रोपलोक्सिन यौगिकों के संश्लेषण के लिए किया गया। समन्वित रूप से एक लोह(II) उत्प्रेरित पर्यावरण अनुकूल एमिनेशन प्रक्रिया विकसित की गई और इसका उपयोग फाइटोल और सिप्रोपलोक्सिन के उत्सर्जन के लिए किया गया।

हानिकारक कृत्रिम (सिंथेटिक) रंगों के अत्यधिक उपयोग के कारण प्राकृतिक रंगों की ओर झुकाव बढ़ा है। विभिन्न सब्जी स्रोतों से खाद्य प्राकृतिक रंगों के निष्कर्षण के लिए एक हरित और सस्ती प्रक्रिया विकसित की गई है। विकसित किए गए रंग गैर-हाइड्रोस्कोपिक, स्थिर और क्रिस्टलीय रूप में थे।

पारंपरिक दवाओं के वैज्ञानिक रूप से सत्यापन के लिए इंसुलिन की कमी के कारण मधुमेह और मिर्गी रोग का सामना करने के लिए एक महत्वपूर्ण सफलता पाई गई। प्रारंभिक नैदानिक परीक्षणों में *पिकोराइजा कुरुआ* और *जिन्कगो*

बाइलोबा के मानकीकृत रस के क्रमशः मधुमेह और मिर्गी रोगों के उपचार में आशाजनक परिणाम दिखे हैं। पी.कुरुआ ने बढ़ी हुई अग्नाशयी बीटा-कोशिका पुनर्जनन, यकृत और गुर्दे के कार्यों में सुधार के साथ मधुमेह से प्रभावित चूहों में इंसुलिन स्राव बढ़ाया व यकृत और गुर्दों की कार्यक्षमा बढ़ाई। जिन्कगो बाइलोबा ने मस्तिष्क के हिप्पोकैम्पस में एमटीओआर ('रैम्पामाइसिन' का स्तनधारी जीवों में लक्ष्य) के अवरोध के माध्यम से व्यावहारिक और स्मृति खोने से जुड़े मिर्गी संबंधी दौरे को दबा दिया। इसके अलावा, 'इपीगैलोकैटेकिन गैलेट' को चूहों के प्रीक्लिनिकल माडल में बढ़ती उम्र और उससे संबन्धित विकारों के प्रतिरोधक स्वरूप सहजीवी क्रियात्मक भोजन में प्रीबायोटिक के रूप में स्थापित किया गया।

उल्लेखनीय है कि सीएसआईआर-आईएचबीटी के छात्रों ने एक नई पहल के अन्तर्गत वैज्ञानिक अभिरुचि और विभिन्न समूहों में विचारों के आदान प्रदान को बढ़ावा देने के लिए एक संगोष्ठी का आयोजन किया। इस संगोष्ठी का विषय 'जैव-आर्थिकी, जैवसंपदा, हिमालय उत्पाद और प्रक्रिया' था। यह उनकी स्वतन्त्र रूप से कार्य करने की क्षमता का परिचायक है।

संस्थान प्रत्येक वर्ष विद्यार्थियों को शैक्षणिक उद्देश्य के लिए आमंत्रित एवं उनका अभिनन्दन करता है ताकि वे संस्थान परिसर, प्रयोगशालाओं और प्रक्षेत्र में भ्रमण कर सकें। इस वर्ष राज्य के भीतर और बाहर से विभिन्न स्कूलों, कॉलेजों, विश्वविद्यालयों के लगभग 3000 छात्रों ने 'जिग्यासा' और अन्य कार्यक्रमों के अन्तर्गत संस्थान का भ्रमण किया।

आधारभूत और वैज्ञानिक विश्लेषणात्मक सुविधाओं व सोच को सुदृढ़ करना उच्च गुणवत्तायुक्त शोध को प्रोत्साहित करने के लिए महत्वपूर्ण है। संस्थान में अब इलुमिना/पैकबायो के नेक्स्ट जेनरेशन सिक्वेंसिंग, मेटाबोलोमिक और प्रोटियोमिक्स प्लेटफार्म, एयरो और हाइड्रो-पोनिक्स युनिट, जेब्राफिश परीक्षण सुविधाओं से युक्त है। इस वर्ष फार्म गतिविधियों को सुदृढ़ करने के लिए पॉली/ग्रीन हाउसों का निर्माण किया गया। सबैटिकल निलयों और सामुदायिक केंद्र के निर्माण कार्य को पूर्ण किया गया। खाद्य प्रसंस्करण के लिए इन्क्यूबेशन सुविधा विकसित करने तथा बंदला गांव में उजाड़ पड़े शोध प्रक्षेत्र के उत्थान के लिए पहल की गई। परिसर के सौंदर्यीकरण और बेहतर कार्यप्रणाली के लिए कई अन्य गतिविधियों को शुरु किया गया जिसमें जलवायु परिवर्तन अध्ययन क्षेत्र के लिए सड़क का विस्तार, ब्लॉक जी एवं एच के सामने तथा संस्थान के प्रवेशद्वार 1 से अतिथिगृह की सड़कों को चौड़ा करना तथा सड़कों के किनारे नए पेड़ों, झाड़ियों और पौधों का रोपण किया गया।

युवाओं में औद्योगिक उद्यमिता को प्रोत्साहित करने और रोजगार सृजन करने हेतु संस्थान में एक इन्क्यूबेशन सेंटर स्थापित किया गया है। वर्तमान में, राज्य के सीएम स्टार्टअप योजना के अन्तर्गत खाद्य प्रसंस्करण, चाय, पुष्प खेती, सुगंध और ई-मार्केटिंग के क्षेत्रों में 10 इनक्यूबेटी काम कर रहे हैं।

संस्थान द्वारा विकसित प्रौद्योगिकियों और अनुसंधान एवं विकास गतिविधियों को भारतीय अंतर्राष्ट्रीय विज्ञान महोत्सव सहित देश के विभिन्न प्रदर्शनियों और व्यापार मेलों में प्रदर्शित किया गया। सामाजिक पहल और संपर्क के लिए संबन्धित विभागों व उद्योगों और अन्य एजेंसियों के साथ संबंधों को विकसित और मजबूत किया गया। विशेष रूप से प्रौद्योगिकी और सामग्री हस्तांतरण के लिए देश के विभिन्न भागों से भागीदारों के साथ कुल 29 समझौते किए गए। यह न केवल वित्तीय आत्मनिर्भरता के लिए एक महत्वपूर्ण कदम है अपितु विज्ञान एवं प्रौद्योगिकी के माध्यम से समाज और उद्योगों को लाभान्वित करने के लिए भी महत्वपूर्ण कदम है।

अनुसंधान परिषद और प्रबंध परिषद से अनमोल परामर्श, सीएसआईआर मुख्यालय से निरंतर प्रोत्साहन और सीएसआईआर सहित विभिन्न एजेंसियों से प्राप्त वित्तीय सहायता के फलस्वरूप हमने औद्योगिक, पर्यावरण एवं सामाजिक उत्थान के लिए वैज्ञानिक उत्कृष्टता और प्रौद्योगिक नेतृत्व हेतु प्रयासों में सफलता प्राप्त की।

जय हिंद

  
(संजय कुमार)

## Major Highlights





## MAJOR HIGHLIGHTS

### CSIR-IHBT made an entry in the SCImago institutional rankings for the first time within top 30 institutes of CSIR, attaining 9<sup>th</sup> place

(Source Table 2 : Prathap, G. (2018) Indian research institutions in the Government sector in SIR 2017. *Current Science*, 10 January 2018, 114(1): 9–11. Reproduced with permission of Current Science Association, India)

National and global rankings of CSIR and its daughter institutions from 2009 to 2017

Indian rank 2017	CSIR and its daughter institutions	Global rank								
		2009	2010	2011	2012	2013	2014	2015	2016	2017
1	Council of Scientific and Industrial Research	135	142	130	117	111	102	105	99	75
2	National Chemical Laboratory	497	532	528	520	505	498	460	441	385
3	Indian Institute of Chemical Technology	554	565	546	527	505	511	520	493	470
4	Central Salt and Marine Chemicals Research Institute	534	542	543	535	534	528	527	510	485
6	Indian Institute of Integrative Medicine					548	558	557	550	510
7	Central Drug Research Institute	657	647	625	605	575	544	537	558	512
8	Institute of Microbial Technology						587	617	644	521
9	Institute of Genomics and Integrative Biology	579	588	586	567	553	544	531	514	524
12	National Institute for Interdisciplinary Science and Technology	617	594	567	527	508	482	425	353	532
14	Institute of Himalayan Bioresource Technology									553
15	North East Institute of Science and Technology								638	556
17	Central Food Technological Research Institute	547	549	522	513	503	505	501	531	566
18	Indian Institute of Toxicology Research	563	564	553	558	588	575	592	606	568
22	Indian Institute of Chemical Biology	670	670	655	614	573	566	566	602	574
23	Central Electrochemical Research Institute	638	637	621	602	612	601	588	567	576
24	National Physical Laboratory India	715	676	626	567	544	528	501	519	582
25	Institute of Minerals and Materials Technology			687	650	627	614	601	628	585
26	Indian Institute of Petroleum									589
27	Central Institute of Medicinal and Aromatic Plants				696		602	610	611	591
29	Central Leather Research Institute	688	695	672	654	626	603	605	633	604
30	National Botanical Research Institute	724	696	654	625	611	595	616	638	605
31	National Environmental Engineering Research Institute	797	766	714	672	619	586		598	605
33	Centre for Cellular and Molecular Biology	647	632	615	585	555	565	565	552	613
35	Central Glass and Ceramic Research Institute		647	629	626	583	564	565	645	616
39	National Metallurgical Laboratory	704	704	688	659	632	621	621	608	630
40	Central Mechanical Engineering Research Institute						639	647	647	638
42	National Aerospace Laboratories					619	604	627	657	639
45	National Institute of Oceanography	734	724	690	662	649	627	630	649	646
50	National Geophysical Research Institute	808	795	763	719	675	641	630	650	658
59	Central Electronics Engineering Research Institute					632	623	644	667	679
	Count	18	19	20	21	23	26	25	27	29

### Institute empowered hill farmers to cultivate wild marigold for enhancing their agricultural income, which also made H.P. the number 1 state within the country in production of its essential oil

A new initiative, CSIR “Mission Aroma”, was taken whereby large stretches of barren and/or under-utilized lands were targeted for production of aromatic crops. During the first phase, an area of 120 ha, owned by 560 farmers, was brought under cultivation of wild marigold using cultivation and processing technologies, and improved variety “Himgold” developed by the institute. This led to production of 3.5 tons of oil that enhanced farmer's income by 2-3 times as compared to traditional crops like wheat/rice.



Field cultivation of wild marigold



Mobile unit for distillation of essential oil

### Introduction of Monk Fruit in the country for the first time

Monk fruit (*Siraitia grosvenorii*) was introduced in the country with due approval from ICAR-National Bureau of Plant Genetic Resources (NBPGR), New Delhi (Import Permit No. 168/2017).

The sweet taste of monk fruit results primarily from a group of cucurbitane-type triterpene glycosides known as mogrosides that are about 300 times sweeter than sucrose. These low calorie sweet compounds have been approved by the U.S. Food and Drug Administration (FDA).



Monk fruit cultivation at CSIR-IHBT

### RESEARCH ARTICLES PUBLISHED IN HIGH IMPACT FACTOR JOURNALS

Author (s)	Year	Title	Name of Journal	IF
Reddy, CB., Bharti, R., Kumar, S., and Das, P.	2017	Supported Palladium Nanoparticle Catalyzed $\alpha$ -Alkylation of Ketones Using Alcohols as Alkylating Agents	ACS Sustainable Chem. Eng., 5(11), pp.9683–9691	6.140
Walia, S., Guliani, A., and Acharya, A.	2017	A Theragnosis Probe Based on BSA/HSA-Conjugated Biocompatible Fluorescent Silicon Nanomaterials for Simultaneous <i>in Vitro</i> Cholesterol Effluxing and Cellular Imaging of Macrophage Cells	ACS Sustainable Chem. Eng., 5, pp.1425	6.140
Kumar, M., Bhatt, V., Nayal, OS., Sharma, S., Kumar, V., Thakur, MS., Kumar, N., Bal, R., Singh, B., and Sharma, U.	2017	CuI Nanoparticles as a Recyclable Heterogeneous Catalyst for C-N Bond Formation Reactions	Catalysis Science & Technology, 7, pp.2857	5.365
Bhattacharjee, D., Thakur, V., Sharma, S., Kumar, S., Bharti, R., Reddy, CB., and Das, P.	2017	Iodine(III) Promoted Ring Contractive Cyanation of Exocyclic $\beta$ -enaminones to Cyanocyclopentanone Synthesis	Adv. Synth. Catal., 359, 2209–2214	5.123
Bhattacharjee, D., Thakur, V., Shil, AK., and Das, P.	2017	Hypervalent Iodine Promoted Aromatization of exo-cyclic $\beta$ -enaminones for the Synthesis of meta- N,N-Diarylaminophenols	Adv. Synth. Catal., 359, pp.2202 –2208	5.123

Author (s)	Year	Title	Name of Journal	IF
Nayal, OS., Thakur, MS., Kumar, M., Kumar, N., and Maurya, SK.	2018	Ligand-free iron(II)-Catalyzed N-alkylation of Hindered Secondary Arylamines with non-activated Secondary and Primary Alcohols via a Carbocationic Pathway	Adv. Synth. Catal., DOI:10.1002/adsc.201701183	5.123
Sharma, R., Kumar, I., Kumar, R., and Sharma, U.	2017	Rhodium-Catalyzed Remote (C-8) alkylation of Quinolines with Activated and Unactivated Olefins: Mechanistic Study and Total Synthesis of EP4 Agonist	Advanced Synthesis & Catalysis, 359, pp.3022	5.123
Thakur, V., Kumar, A., Sharma, N., Shil, AK., and Das, P.	2018	Supported Palladium Nanoparticles Catalyzed Reductive Carbonylation of Nitroarenes to N-arylformamides	Adv. Synth. Catal., 359, pp.1–7	5.123
Sharma, E., Joshi, R., and Gulati, A.	2018	L-Theanine: An astounding sui generis integrant in tea	Food Chemistry, DOI: 10.1016/j.foodchem. 2017.09.046	4.946
Dhiman, AK., Kumar, R., Kumar, R., and Sharma, U.	2017	Metal-free Synthesis of 2-substituted- 3-(2- hydroxyaryl) Quinolines and 4-(2- hydroxyaryl) Acridines via Benzyne Chemistry	The Journal of Organic Chemistry, 82, pp.12307	4.805
Gangwar, I., Sharma, NK., Panzade, G., Awasthi, S., Agrawal, A., and Shankar, R.	2017	Detecting the Molecular System Signatures of Idiopathic Pulmonary Fibrosis through Integrated Genomic Analysis	Scientific Reports, DOI:10.1038/s41598-017-01765-6	4.122
Goel, P., Sharma, NK., Bhuria, M., Sharma, V., Chauhan, R., Pathania, S., Swarnkar, MK., Chawla, V., Acharya, V., Shankar, R., and Singh, AK.	2018	Transcriptome and Co-Expression Network Analyses Identify Key Genes Regulating Nitrogen Use Efficiency in <i>Brassica juncea</i> L.	Scientific Reports, 8(1), DOI: 10.1038/s41598-018-25826-6	4.122
Kumar, G., Gupta, K., Pathania, S., Swarnkar, MK., Rattan, UK., Singh, G., Sharma, RK., and Singh, AK.	2017	Chilling Affects Phytohormone and Post-Embryonic Development Pathways during Bud Break and Fruit Set in Apple ( <i>Malus domestica</i> Borkh.)	Scientific Reports, 7, pp.42593, Doi: 10.1038/srep42593.	4.122
Kumar, S., Subbarao, BL., and Hallan, V.	2017	Molecular Characterization of Emaraviruses Associated with Pigeonpea Sterility Mosaic Disease	Scientific Reports, DOI:10.1038/s41598-017-11958-8.	4.122

Author (s)	Year	Title	Name of Journal	IF
Roshan, R., Kulshreshtha, A., Kumar, S., Purohit, R., and Hallan, V.	2018	AV2 Protein of <i>Tomato leaf curl Palampur Virus</i> Promotes Systemic Necrosis in <i>Nicotiana benthamiana</i> and Interacts with host Catalase2	Scientific Reports, DOI:10.1038/s41598-018-19292-3.	4.122
Singh, G., Singh, G., Singh, P., Parmar, R., Paul, N., Vashist, R., Swarnkar, MK., Kumar, A., Singh, S., Singh, AK., Kumar, S., and Sharma, RK.	2017	Molecular Dissection of Transcriptional Reprogramming of Steviol Glycosides Synthesis in Leaf Tissue During Developmental Phase Transitions in <i>Stevia rebaudiana Bert.</i>	Scientific Reports, 7, pp.11835, DOI:10.1038/ s41598-017-12025-y.	4.122
Singh, P., Singh, G., Bhandawat, A., Singh, G., Parmar, R., Seth, R., and Sharma, RK.	2017	Spatial Transcriptome Analysis Provides Insights of key Gene(s) Involved in Steroidal Saponin Biosynthesis in Medicinally Important herb <i>Trillium govanianum</i>	Scientific Reports, 7, pp.45295, DOI: 10.1038/srep45295.	4.122
Singh, RM., Singh, D., and Hallan, V.	2017	Movement Protein of Apple Chlorotic Leaf Spot Virus is Genetically Unstable and Negatively Regulated by Ribonuclease E in <i>E. coli.</i>	Scientific Reports, 7, pp.2133, DOI:10.1038/s41598-017-02375-y.	4.122
Singla, R., Soni, S., Patial, V., Kulurkar, P., Kumari, A., Mahesh, S., Padwad, Y., and Yadav S.	2017	Cytocompatible Anti-microbial Dressings of <i>Syzygiumcumini</i> Cellulose Nanocrystals Decorated with Silver Nanoparticles Accelerate Acute and Diabetic Wound Healing	Scientific Reports, 7, pp.10457, DOI: 10.1038/s41598-017-08897-9	4.122

## *Technologies Available with CSIR-IHBT*



## TECHNOLOGIES AVAILABLE WITH CSIR-IHBT

S. No.	Title of Product/Process/Design/Equipment Developed	Market Size
1.	Superoxide Dismutase (SOD)	World Enzyme Demand (Industrial and Speciality) 6,950 US\$ million in 2017 expected to reach 9,500 US\$ million.
2.	Variant of Super Oxide Dismutase (SOD)	World Enzyme Demand (Industrial and Speciality) 6,950 US\$ million in 2017 expected to reach 9,500 US\$ million.
3.	Phospholipase	World Enzyme Demand (Industrial and Speciality) 6,950 US\$ million in 2017 expected to reach 9,500 US\$ million.
4.	Crispy Fruits and Vegetables	Global freeze-dried product market is expected to grow at a CAGR of 7.23%. During the forecast period of 2016-2021, and reach \$66.53 billion by 2021.
5.	Ready to Eat Preservative Free Food (Kangri Dham and Khichri products)	It is expected that the ready meals market in India would continue to grow at a CAGR of approximately 12.36% during the period 2016-21 and reach INR2, 901.53 million by 2020.
6.	Nutritionally enriched Fruit Bar, Cereal Bar, and Nut Bar	India energy bars market is projected to grow at a CAGR of over 28%, in value terms, during 2017-2022.
7.	Gluten Free Buckwheat Products	The global market for gluten-free products market was valued at US\$ 4.63 billion in 2015 and is projected to reach US\$ 7.59 billion by 2020, at a CAGR of 10.4% from 2015 to 2020.
8.	Bamboo Candy	Towards the end of 2027, bamboos at the global level, will generate revenues worth over US\$ 10 billion. During the forecast period 2017-2027, the global bamboos market is projected to soar at a value CAGR of 10.6%.
9.	Multigrain High Protein Beverage Mixes and Soup Mixes	
10.	Spirulina Peanut Bar	Global spirulina market is expected to register a CAGR of 10% during the forecast period, and is estimated to be valued at nearly US\$ 2,000 million by 2026, from more than US\$ 700 million in 2016.

S. No.	Title of Product/Process/Design/Equipment Developed	Market Size
11.	Production of Aescin from <i>Aesculus indica</i>	Up to 500 000 tonnes of <i>Aesculus</i> seeds are produced each year around the world, with the biggest proportion coming from the northern hemisphere. China 40% (100,000-240,000 tons/year), Korea 15% (up to 80,000 tons/year), Italy, Turkey, Japan around 10% each (up to 30,000 tons/year) and other countries 1-4% are the world's largest producers of <i>Aesculus</i> .
12.	Mini Distillation Unit Herbestill™	
13.	Gel Processing and Transfer Device (GEPOTED)™	
14.	A kit for isolation of RNA	
15.	Tea Withering Machine	
16.	Tea Catechins	Global market demand for the tea polyphenols was approximated at 4870 tons in year 2012 and it is predicted to grow at a CAGR rate of 8.5% during the forecasted period from year 2013 to year 2022.
17.	Tea Wine	Global wine market was valued at approximately US\$ 302.02 billion in 2017 and is expected to generate revenue of around US\$, 423.59 billion by the end of 2023, growing at a CAGR of around 5.8% between 2017 and 2023.
18.	Herbal Tea	
19.	Tea Concentrates	
20.	Technology for Manufacturing of Natural Colours	Food colors market is projected to reach US\$ 3.75 billion by 2022, at a CAGR of 8.40% from 2016.
21.	Diagnostic kits for <i>Prunus necrotic ringspot virus</i> (PNRSV)	
22.	Development of New Plant Variety of Stevia (Him Stevia)	
23.	Development of New Plant Varieties of Gerbera (Him Glow and Him Peace)	
24.	Development of New Plant Varieties of Rose (Thorn- less Rose and Himalayan Wonder)	
25.	Developing L-Asparaginase with Low Glutaminase Activity for Therapeutic Applications	
26.	Process for Scalable Production of 4-substituted cyclohexane-1,3-diones	
27.	Process Development for 4-alkyl resorcinols production from 4-alkyl cyclohexane-1,3-diones	



S. No.	Title of Product/Process/Design/Equipment Developed	Market Size
28.	5-Hydroxymethylfurfural (HMF) Production from Carbohydrates	The global market for 5-HMF is expected to reach about 123.279 billion US\$ by 2022 from 116.750 billion US\$ in 2016.
29.	Processing of Stevia Leaves and conversion into Stevia Liquid Drops	Stevia market is expected to reach US\$ 565.2 million by 2020, reflecting a CAGR of 8.5% during the forecast period.
30.	Production of Steviol Glycosides from Dry Stevia Leaves	
31.	Production of Efficient Bio-fertilizer using Strains of <i>Pseudomonas trivalis</i> 745	
32.	Biofertilizers/PGPR to Assist Saffron Production in Unexplored New Himalayan Area	
33.	Production of Bamboo Charcoal	Global activated carbon market was valued at US\$ 4.74 billion in 2015 and is projected to reach US\$ 8.12 billion by 2021, at a CAGR of 9.4% from 2016 to 2021
34.	Nano- encapsulated Curcumin for Health and Cosmetics	Global curcumin market is expected to reach US\$ 94.3 million by 2022. India is the largest manufacturer of curcumin with production exceeding 80% of global market.
35.	Alternate Sweeteners (Monk Fruit)	
36.	Conversion of Camphor into Borneol	d-Borneol one of the reduction product of d-camphor have very high value in the market (Rs. 40000 – 80000 per kg) and huge market (1-10 metric tonnes per year).
37.	Process for Extraction of Sapium Wax	Global wax market is expected to reach US\$ 12.9 billion by 2025, and is expected to grow at a CAGR of 3.7% from 2017 to 2025.
38.	Development of Bio-lubricants from Sapium Oil	The bio-lubricants market is expected to grow from an estimated US\$ 2.47 billion in 2017 to reach US\$ 3.36 billion by 2022, at a CAGR of 6.4% between 2017 and 2022
39.	Development of Feed/ Protein Concentrate from Sapium Seed Meal.	Global animal feed protein ingredients market is poised to cross US\$ 200 billion by 2024.
40.	Process for the Avibactam	
41.	Development of Process for Converting Raw Cellulosic Biomass into Textile Fiber and Nano- cellulose	The global cellulose fibers market is expected to reach at US\$ 36.96 billion in 2020 at a CAGR of 9.49% over the period between 2015 and 2020.



## CSIR-IHBT Technologies Rolled Out



## CSIR-IHBT TECHNOLOGIES ROLLED OUT

S. No.	Title of agreement/MoUs	Name of company with whom agreement/MoUs were signed and technology transferred	Date of signing
1.	Aseptic culture of apple rootstocks, improved stevia variety HIMSTEVIA, gerbera, carnation and liliium	M/s Madan Tissue Culture Lab, Alampur, District Kangra (H.P.)	19/04/2017
2.	Manufacturing of tea catechin	M/s Indcoserve (The Tamilnadu Cooperative Tea Factories Federation Limited) Coonor, Nilgiris, Tamilnadu	30/06/2017
3.	Mass multiplication of bamboo species	M/s Beej Sheetal Research Pvt. Ltd., Jalna, Maharashtra	07/08/2017
4.	RS-GIS	M/s Excel Geomatics Pvt. Ltd., A-67, SF, Parsvnath Paradise, Mohan Nagar, Ghaziabad	17/08/2017
5.	Setting up stevia cultivation in 15 acres at village Sayan Khurd and Kuhli Khurd, District Ludhiana	Mr. Manjinder Singh s/o Sh. Jagjit Singh H.No. 2567/1, Street No. 6, Jammu Colony, Atom Park, Ludhiana	23/08/2017
6.	Bio-prospection of Himalayan bioresource and possesses scientific expertise to develop field efficacy data against tea mites	Crystal Crop Protection Pvt. Ltd., Ellisbridge, Ahmedabad	31/08/2017
7.	Full spectrum of operations of tissue culture of potato varieties	M/s Dhauladhar Bioplant, Village Prei, Tehsil Shahpur, District Kangra (H.P.)	05/09/2017
8.	Processing of stevia leaves and conversion into stevia liquid drops	M/s Himalaya Natural & Herbal Products, VPO Bundla, Palampur (H.P.)	06/10/2017
9.	Manufacturing/ processing of Nutri Bar products	M/s Access India Impex Centre Pvt. Ltd., Kasturba Gandhi Marg, New Delhi	09/10/2017
10.	Joint collaboration in areas of mutual interest	Department of Ayurveda, Govt. of Himachal Pradesh	11/10/2017
11.	Catalyzing bio-economy in a sustainable manner	Agriculture Skill Council of India (ASCI) Ministry of Skill Development & Entrepreneurship Govt. of India, Sector-44, Gurugram, Haryana	12/10/2017
12.	Ready to eat preservative free Khichri product	M/s Dexter Retail and Distribution Pvt. Ltd., Kasturba Gandhi Marg, New Delhi	07/11/2017

S. No.	Title of agreement/MoUs	Name of company with whom agreement/MoUs were signed and technology transferred	Date of signing
13.	To provide incubation facility to make ready to drink healthy beverages for medicated/herbal tea, iced tea products and develop self heating and cooling technology	Mr. Paritosh Bhardwaj, Vill. Dhanyater, Tehsil Jogindernagar, District Mandi (H.P.)	05/12/2017
14.	To provide incubation facility to modify the natural juices based on sensory properties on the terms and conditions herein after contained	Mr. Sahil Dutta, M/s Backyard Garden Pvt., Ltd., Himuda Colony Phase-3, Kangnadar, New Shimla (H.P.)	05/12/2017
15.	R&D work related to Damask rose plants (1000 plants)	IIT at Mandi, Parashar Road, Tehsil Sadar, Kamand, (H.P.)	07/12/2017
16.	Damask rose cutting (5000 cuttings)	Chamkaur Singh, S/o Nazar Singh, VPO Rure Di Kalan, Tehsil Tapa, District Barnala, Punjab	26/12/2017
17.	To provide incubation facility to make flavored tea, regular tea (dip tea), blended tea and tea extract for cosmetics	Mr. Rakesh kumar, VPO Kand Gwal Tikker, Tehsil Palampur, District Kangra (H.P.)	26/12/2017
18.	Damask rose cutting (5000 cuttings)	Mr. Vijay Kumar, 1720, Lodhi road Complex, New Delhi	12/01/2018
19.	Production of bamboo charcoal and powder at CSIR-IHBT	M/s Biogen Biotics Pvt Ltd., Ashirwad Complex, Green Park New Delhi	19/01/2018
20.	Production of honey vinegar	Mr. Aman Patial C/o House No 60/4, Bhojanagr, Sundernagar, District Mandi (H.P.)	29/01/2018
21.	Production of nutritionally enriched fruit burfi	Mr. Akash Patial C/o House No 60/4, Bhojanagr, Sundernagar, District Mandi (H.P.)	29/01/2018
22.	Damask rose cutting (2500 cuttings)	M/s Sahara NGO (Society of Scientific Advancement of Hill and Rural Areas), Sainj, Kullu (H.P.)	29/01/2018
23.	To establish stevia plantation in 3 acre land in Una (H.P.)	M/s Harsh organic farms Village Jankaur District Una (H.P.)	20/02/2018
24.	Incubation facility in plant tissue culture and aeroponics	Mr. Sandeep Kumar, VPO Trilokpur, Tehsil Jawali, District Kangra (H.P.)	05/03/2018
25.	E-trading platform for MAPs and commercially important crops	Mr. Chandan Sood M/s Appleway International, Baddi, Tehsil Nalagarh, District Solan (H.P.)	12/03/2018

S. No.	Title of agreement/MoUs	Name of company with whom agreement/MoUs were signed and technology transferred	Date of signing
26.	Cultivation of stevia at 10 acre in Konda Gaon, District Bastar Chattisgarh	M/s Maa Danteshwari Herbal Products Ltd., District Bastar, Chattisgarh	22/03/2018
27.	Establish processing technology for extraction of steviol glycosides	M/s Maa Danteshwari Herbal Products Ltd., District Bastar, Chattisgarh	22/03/2018
28.	Damask rose plants (500 rooted plants)	Mr. Shishu Patiyal, VPO Kandwari, Tehsil Palampur, District Kangra (H.P.)	27/03/2018
29.	Damask rose cutting (1000 cutting)	Mr. Gian Chand, Village Lot, District Mandi (H.P.)	27/03/2018





## *Mission Mode Projects*



## CSIR AROMA MISSION

CSIR Aroma Mission was launched by CSIR to bring about transformative changes in the aroma sector by fueling industrial growth and catalyzing rural empowerment. Five CSIR labs from different agro-climatic zones of the country viz., CIMAP, IHBT, IIIM, NBRI and NEIST are participating to:

- Develop superior varieties and agro-technologies
- Assess their suitability in specific agro-climatic regions
- Bring about 5500 ha of additional area under captive cultivation of aromatic cash crops, particularly targeting rain-fed /degraded lands across the country
- Provide technical and infrastructural support to farmers/growers of the country for distillation and value-addition
- Enable effective buy-back mechanisms to ensure remunerative prices
- Value-addition to essential oils and aroma ingredients for their integration in global trade and economy

### Activities undertaken by CSIR-IHBT

The focus of CSIR-IHBT during the current year was to cover 530 hectares land under cultivation of *Tagetes minuta* (wild marigold), *Valeriana jatamansi* (muskbala), *Rosa damascena* (damask rose), *Dracocephalum heterophyllum* (shimthingle), *Artemisia maritima* (sea wormwood) and *Cymbopogon flexuosus* (lemongrass) in different agro-climatic regions of H.P. (Fig. 1).



*Tagetes minuta*



*Rosa damascena*



*Cymbopogon flexuosus*



*Valeriana jatamansi*



*Dracocephalum heterophyllum*



*Artemisia maritima*

Fig. 1 Crops under CSIR Aroma Mission

## Varietal improvement through breeding

### *Tagetes minuta*

Seeds from wild germplasm representing 334 locations of Himalayan regions of Mandi, Kangra, Chamba and Kullu were collected and characterized for morphological and essential oil parameters. These are being grown at CSIR-IHBT. Out of these, 18 were selected for high biomass yield, early maturity, their suitability in stressed degraded lands and low irrigation requirements. From these, eight potential selections were made on the basis of essential oil parameters (up to 0.3% essential oil content and having higher proportion of ocimenones) (Fig. 2).



Fig. 2 Evaluation trials of *Tagetes minuta*

### *Valeriana jatamansi*

Twenty-four germplasm accessions were collected from different regions of western Himalayas and established at CSIR-IHBT. Seedling populations obtained from these germplasm lines were characterized morphologically. Large variations in leaf size, leaf number, plant height and fresh biomass were recorded, and 915 plants were screened. These plants were further characterized morphologically. Out of these, six selections were made on the basis of root and rhizome biomass. The essential oil content up to 0.4% and valepotriate content of 4% was recorded. These selections are being evaluated in multilocation trials at high altitude regions (Fig. 3).



Fig. 3 Phenotypic variations among different accessions of *Valeriana jatamansi*

### *Dracocephalum heterophyllum*

Four germplasm accessions were collected from high altitude regions of Leh, Ladakh (J&K) and Spiti (H.P.). Seedling populations were established at CSIR-IHBT, Palampur. The populations obtained from these collections were characterized morphologically. A total of 182 plants were screened based on morphological attributes like leaf size, leaf number, plant height and fresh aerial biomass. These plants were further characterized for morphological traits. Out of these, 6 selections were made on the basis of aerial biomass. The essential oil content was up to 0.3%. These selections are being evaluated in multilocation trials at high altitude regions (Fig. 4).



Fig. 4 Accessions of *Dracocephalum heterophyllum*

### *Rosa damascena*

Germplasm accessions being maintained at CSIR-IHBT, Palampur were screened for morphological variations and four genotypes were selected. These selected genotypes were clonally multiplied through cuttings for generation of planting material under polyhouse conditions (Fig. 5). The essential oil content was up to 0.03%. These four potential selections and two control lines are being evaluated in the multilocation trials.



Fig. 5 Generation of planting material through stem cuttings of *Rosa damascena*

### *Artemisia maritima*

Eight germplasm accessions representing different locations of Lahaul region were collected and are being maintained at CeHAB, Ribling, district Lahaul & Spiti, H.P. Seedling populations were raised and 150 plants were screened on the basis of morphological variations. Eight potential selections were made on the basis of high essential oil content of up to 0.17%. These selections are being evaluated in the multilocation trials at high altitude regions (Fig 6).



Fig. 6 Generation of planting material of *Artemisia maritima*

### Promotion of cultivation and processing of aromatic crops

During the year a total area of about 122 ha was brought under aromatic crop cultivation. Of this *T. minuta* 118 ha with 70 ha in H.P. (30.54 ha in Kullu district, 29.64 ha in Mandi district and 9.84 ha in Chamba district), 33 ha in Kupwara district in J&K (with CSIR-IIIM, Jammu), 11 ha in Uttar Pradesh (8 ha in Bareilly and 3 ha in Meerut) and 4 ha in Sanapati district of Manipur. About 3.5 tons of *T. minuta* essential oil was produced. In addition, 10 ha crop land of lemongrass was rejuvenated in different warmer regions of the state viz., Amb, Una, Nurpur. An area of 3.28 ha was covered under damask rose in H.P., Punjab, Uttarakhand, Delhi and Manipur states. Given below are the pictures of the field activities under the mission (Fig. 7-10).



Seed distribution to the farmers



Field view of the crop at early stage



Crop being harvested



Field view of the crop at maturity stage

Fig. 7 Field activities related to wild marigold



Harvested crop carried to distillation site



Crop and biomass recording



Distillation at farmers' field



Fig. 8 Promotion of wild marigold (*Tagetes minuta*) crop



Fig. 9 Distribution of planting material of damask rose to farmers in Punjab



Fig. 10 Rehabilitation of lemongrass fields in different locations of Himachal Pradesh and oil distillation

### Generation of quality planting material

Given below is the detail of quantities of the planting material of the target aromatic crops generated during the year (Fig. 11 and Table 1) .

**Table 1 Details of planting material generated**

Crop	Planting material generated
<i>Rosa damascena</i>	50,000 rooted plants
<i>Artemisia maritima</i>	400 rooted plants
<i>Valeriana jatamansi</i>	1,50,000 rooted plants & 1 kg seed
<i>Dracocephalum hetrophyllum</i>	5,000 rooted plants
<i>Artemisia maritima</i>	15 kg seeds



(A) *R. damascena*



(B) *D. hetrophyllum*



(C) *V. jatamansi*



(D) *A. maritima*



(E) *A. maritima* seeds sown at Keylong, Lahaul



(F) *V. jatamansi* seeds

**Fig. 11 Raising nurseries of aromatic crops**

### Standardization of fractionation technology

Compounds of  $\beta$ -ocimene and dihydrotagetone (DHT) from *T. minuta* and patchouli alcohol from *V. jatamansi* were isolated (Fig. 12 and Table 2).

**Table 2 Fractionation products of *T. minuta* and *V. jatamansi***

Essential Oil	Fraction	Capacity Level
<i>T. minuta</i>	Ocimene rich	20 g level (8 g)*
<i>T. minuta</i>	Dihydrotagetone rich	20 g level (2 g)*
<i>V. jatamansi</i>	Patchouli alcohol	15 g level (4-5 g)*



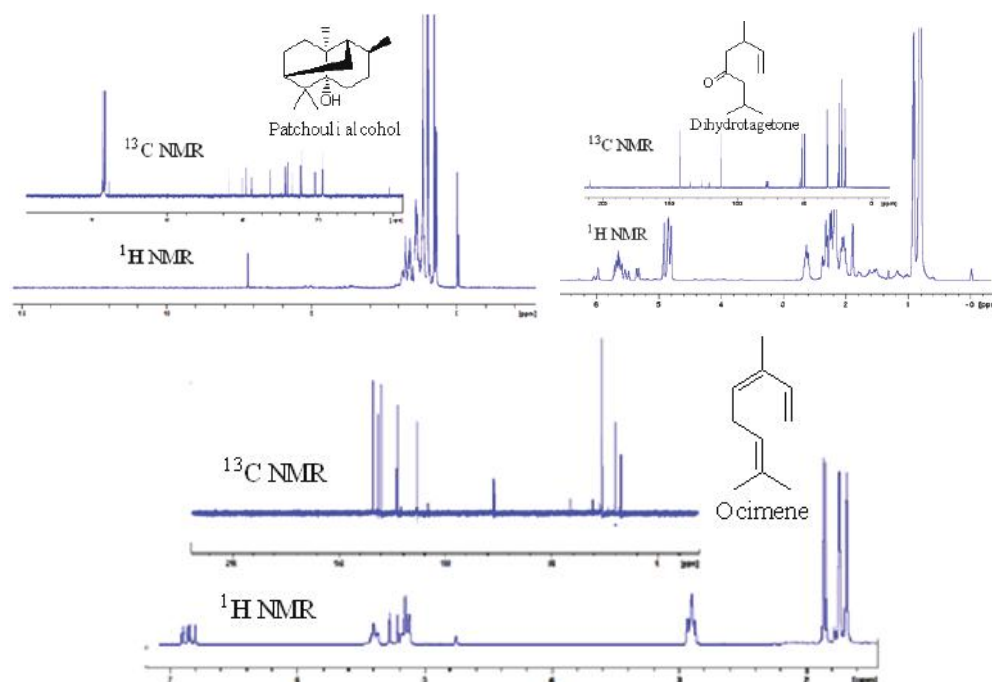

Fig. 12 Fractionation products developed by CSIR-IHBT

### Products developed

Six perfume quality blends were developed using the aromatic oils of western Himalayan flora (Fig 13). A synergy based antimicrobial formulation was also developed.



Fig. 13 Perfumes developed at CSIR-IHBT

### Training and awareness programmes for skill development

Eighteen awareness cum training programs on cultivation and processing technologies of aromatic crops were organized up to March 2018, and 532 unemployed youth, rural women and farmers were trained. Practical demonstrations on field preparation for nursery beds, plantation and harvesting of crops to obtain higher essential oil content and composition, essential oil extraction at mini distillation unit and pilot plant were imparted. Farmers were also motivated for the cultivation and price determination of aromatic crops namely damask rose, wild marigold, valeriana, lavender and rosemary (Table 3 and Fig. 14)

**Table 3 Training programs organized under Aroma Mission**

Program	Duration	Location	District	State	No. of Participants
Training on improved agro and process technology of damask rose	11-12.12.2017	CSIR-IHBT	Kangra	H.P.	2
Awareness programme on cultivation of aromatic crops	15.12.2017	Khundian and Amb	Una	H.P.	26
Training cum demonstration on distillation of essential oils	18.01.2018	Bringal	Una	H.P.	12
Training cum awareness programme	25.01.2018	Palampur	Kangra	H.P.	12
Awareness programme on cultivation of aromatic crops	31.01.2018 to 02.02.2018	Mualkawi	Champai	Mizoram	12
Training programme on cultivation and processing of aromatic crops in North East region	5.02.2018	Makhan	Kangpopki	Manipur	84
Awareness programmes on cultivation of damask rose	4.02.2018	Padli	Nainital	U.K.	15
Awareness programmes on cultivation of damask rose	7.02.2018	Bajun	Nainital	U.K.	20
Awareness programme on cultivation of lemon grass	16.02.2018	Jwalaji	Kangra	H.P.	30
Awareness cum training programme on cultivation of aromatic crops	22.02.2018	Reasi	Reasi	J&K	30
Awareness cum training programme on cultivation of lemon grass	26.02.2018	Nurpur	Kangra	H.P.	11
Awareness cum training programme on cultivation of aromatic crops	14.03.2018	Hingori, Chirgaon	Shimla	H.P.	25
Awareness cum training programme on cultivation of aromatic crops	14.03.2018	Seraj	Mandi	H.P.	75
Awareness cum training programme on cultivation of aromatic crops	15.03.2018	Hunchali, Chirgaon	Shimla	H.P.	29
Awareness cum training programme on cultivation of aromatic crops	16.03.2018	Beuri, Chirgaon	Shimla	H.P.	20
Awareness programme on cultivation of aromatic crops	16.03.2018	Sunkiya	Nainital	U.K.	69
Awareness cum training programme on cultivation of aromatic crops	19.03.2018	Ludhiana	Ludhiana	Punjab	10
Skill development programme on cultivation and primary processing of economically important aromatic plants	27-29.03.2018	-	Nongstoin	Meghalaya	50



Imparting training to young farmers at CSIR-IHBT, Palampur (H.P.)



Awareness on cultivation of lemongrass in distt. Una (H.P.)



Awareness cum training on improved agro and process technology of damask rose at CSIR-IHBT, Palampur (H.P.)



Training cum demonstration of essential oil distillation at village Bringal, Una (H.P.)



Awareness cum training on cultivation of damask rose in village Padli, Nainital (Uttarakhand)



Awareness cum training on cultivation of damask rose in village Bajun, Nainital (Uttarakhand)



Awareness program on lemon grass cultivation in Nadaun & Jawalaji (H.P.)



Awareness cum training program on cultivation of aromatic crops to farmers of distt. Reasi (J&K)



Training cum awareness program on lemon grass in Jawalaji (H.P.)



Awareness cum training on cultivation of aromatic crops at village Hingori Teh. Chirgaon distt. Shimla (H.P.)



Awareness cum training on cultivation of aromatic crops at village Songar, distt. Mandi (H.P.)



Awareness cum training on cultivation of aromatic crops at village Hunchali, Teh. Chirgaon, distt. Shimla (H.P.)



Awareness cum training on cultivation of aromatic crops at village Beuri, Teh. Chirgaon, Shimla (H.P.)



Awareness cum training on cultivation of aromatic crops at village Sunkiya, Nainital (Uttarakhand)



Awareness cum training on cultivation of aromatic crops at CSIR-IHBT, Palampur (H.P.)



Awareness program on cultivation of aromatic crops at distt. Champai (Mizoram)



Training program on cultivation and processing of aromatic crops at distt. Kangpokki (Manipur)



Skill development program organized at distt. Nongstoin (Meghalaya)

Fig. 14 Snapshots of training and awareness programs conducted by CSIR-IHBT

### Showcasing of Aroma Mission activities in Mizoram

Aroma Mission activities were exhibited at Aizawl, Mizoram on the occasion of the visit of Hon'ble Prime Minister of India on 16<sup>th</sup> December, 2017. The Directors and Scientists of CSIR-IHBT and CSIR-NEIST participated in this activity and portrayed technologies relevant to North-eastern regions of the country (Fig. 15).



Fig. 15 Showcasing of research activities and products of CSIR-IHBT at Aizawl, Mizoram

## Development of agrotechnologies

### Damask rose (*Rosa damascena*)

Damask rose is one of the most expensive essential oil bearing crop. To study the microclimate modification effect on growth, yield and quality of damask rose, a field experiment was conducted during 2017 in split plot design with the main plot containing three shade levels *viz.*, control (without shade), 25% shade, 50% shade and three mulch levels *viz.*, control (without mulch), organic mulch (poplar leaf mulch) and black polyethylene mulch in sub plots. Fresh flower yield was significantly higher under control (3392.4 kg ha<sup>-1</sup>) followed by 25% (2970.3 kg ha<sup>-1</sup>) and 50% shade level (1841.4 kg ha<sup>-1</sup>). Plants mulched with black polyethylene mulch produced significantly higher flower yield (3172.4 kg ha<sup>-1</sup>) as compared to organic mulch (2753.2 kg ha<sup>-1</sup>) and without mulch (2287.1 kg ha<sup>-1</sup>). Significantly higher essential oils yield was recorded in open sunny conditions as compared to 25% shade and 50% shade level. Among mulches, black polyethylene mulch recorded significantly higher essential oil yield as compared to organic and no mulch (Fig. 16).

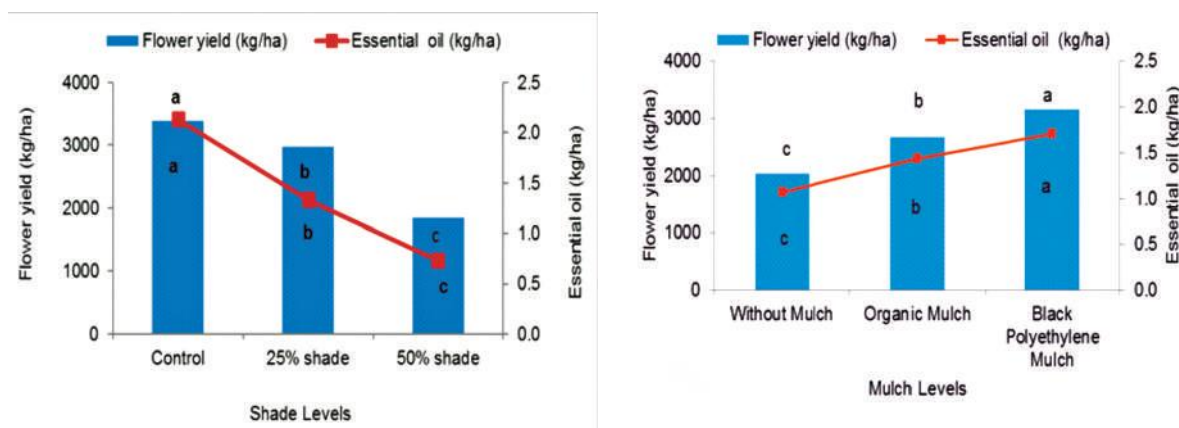

Fig. 16 Effect of microclimate modification on flower and essential oil yield of damask rose

The yield and quality of essential oil is principally governed by the distillation conditions like temperature, duration (time) of extraction, and water-to-solid ratio. Therefore, an experiment was conducted to optimize these conditions using response surface methodology (RSM) combined with central composite design for higher yield and quality of essential oil from hydro-distillation. Based on the regression analysis of the RSM model, the optimum temperature was 75° C, duration of 2.5 h and water-to-solid ratio was 2.94. The predicted oil recovery was 0.062 %.

### Wild marigold (*Tagetes minuta*)

*Tagetes minuta* commonly known as wild marigold is a perennial herbaceous aromatic essential oil yielding plant. Effect of pinching and harvesting stages on duration of phenophases, aerial biomass partitioning and essential oil productivity were studied. All the phenological stages were delayed by pinching. The crop took 93 to 103 days, respectively under control and pinching from transplanting to 100% flowering. Biomass accumulation into leaf, flower and stem was enhanced by pinching. Pinching and 100% flowering stage recorded significantly higher fresh biomass

and essential oil content than other treatments. Major constituents of essential oil (Z)- $\beta$ -ocimene and (E)-ocimenone increased, while dihydro tagetone and (E)-tagetone decreased with delay in harvesting from bud initiation to 100% flowering stage (Fig. 17). Higher biomass, oil content and quality of *T. minuta* was achieved by pinching at initial stages and harvesting the crop at full bloom stage i.e. 100% flowering.

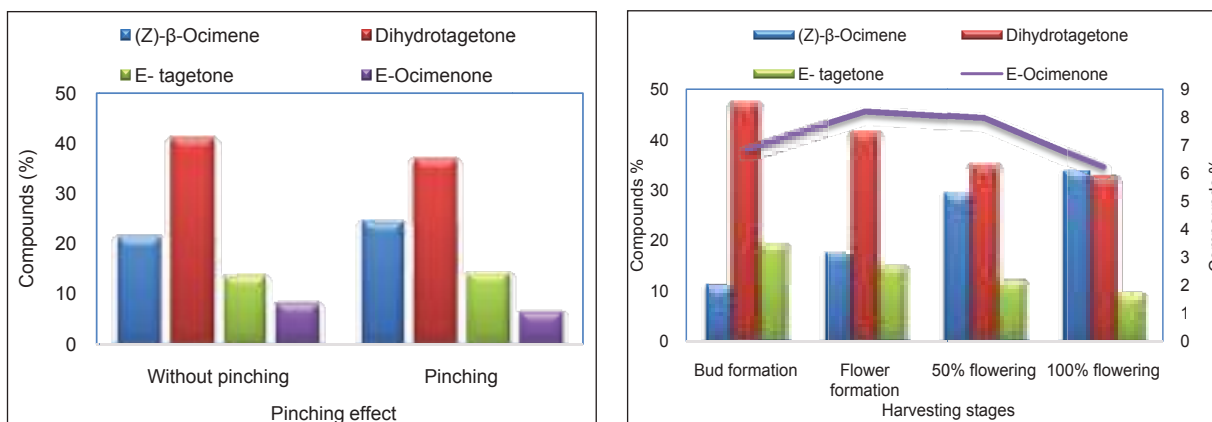

Fig. 17 Effect of pinching and harvesting stage on essential oil composition of *T. minuta*

Another field experiment was conducted comprising of two planting methods (line sowing and broadcasting) and five levels of seed rate (2, 3, 4, 5 and 6 kg/ha) to standardize the planting method and seed rate for higher productivity of *T. minuta* under the western Himalaya conditions. The analyzed data revealed that broadcasting method significantly increased biomass yield by about 8 to 15 %, irrespective of seed rate, compared with line sowing method (Fig. 18). Among the seed rate, the maximum biomass yield was recorded with sowing of 4 kg seed/ha. However, the oil content in biomass and proportion of different components were not significantly changed due to seed rate.

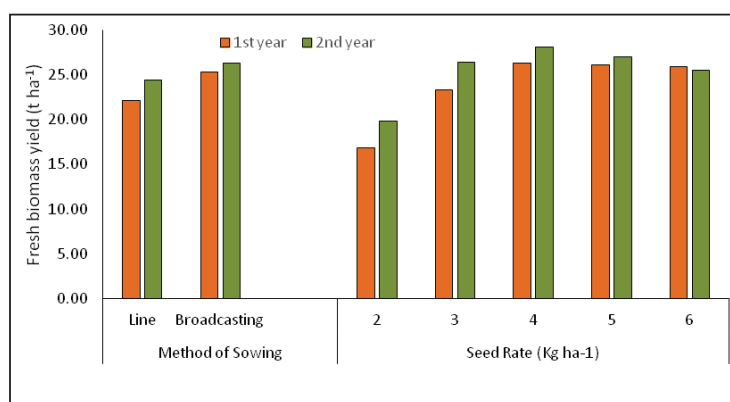

Fig. 18 Effect of sowing method and seed rate on biomass yield

### Bee Keeping

The institute introduced bee keeping facility in IHBT under Aroma Mission for training and demonstrations to the farmers for pollination, to increase the production and for additional

income. The farmer is expected to earn a net income of 1.60 lakh in the first year with initial investment cost of Rs. 3.0 lakhs through bee keeping of 50 colonies. Commercial banks/Regional Rural banks/State Cooperative Banks provide 40% subsidy (limited to Rs. 88,000/ unit of 50 bee colonies with beehives, supers and other bee keeping equipment) to farmers for bee keeping.

In addition, improved Flow Hive was procured for instant harvesting of quality honey. An innovation in designing the improved flow hive for honey extraction is under progress and will be available to farmers at reasonable cost in future (Fig. 19).



**Fig. 19 (A) Improved flow hive and (B) bee frame with bees**

## CSIR-PHYTOPHARMACEUTICAL MISSION

Botanical drugs are being used as medicines for the treatment of a range of diseases, since ancient times. According to the World Health Organization (WHO), about 65-80% of the world's population from developing countries depend essentially on plants for primary health care. Currently, the major pharmaceutical companies have demonstrated renewed interest in higher plants as sources for new lead molecules and phytopharmaceuticals with proven efficacy, safety and quality. In order to tap this opportunity and make India a global leader, the Phytopharmaceutical Mission was launched by CSIR. The mission aims to employ cohesive and integrative approaches and increase the productivity of botanical raw drugs.

Under the mission, CSIR-IHBT targeted four important medicinal plants namely, *Podophyllum hexandrum*, *Picrorhiza kurroa*, *Fritillaria roylei* and *Trillium govanianum* and participated in all the activities to provide end to end solutions for these species with the following objectives.

- Generation of quality planting materials for captive cultivation of selected medicinal plants and to develop region specific agro-technologies.
- Captive cultivation of selected high value rare, endangered and threatened (RET) medicinal plant species, their collection and characterization for creation of gene banks.
- Development of mass multiplication protocols of selected species.
- Technology packages for production of Good manufacturing practices (GMP) grade medicinal plant extracts for domestic and international markets.
- Phytopharmaceutical development from important medicinal plants as per regulatory guidelines of DCG(I) and AYUSH.
- Intellectual property generation, valuation and management.
- Making public aware of mission activities and achievements using appropriate interface.

### Diversity collection and characterization

A total of 701 genotypes representing 48 populations of four species were collected from different geographical locations of H. P. and J & K. Additionally, 260 collections of *F. roylei* and *T. govanianum* were also made during this time. The GPS and environmental parameters of these locations were also documented. Next-generation genomic resources were created for three out of four targeted species. In order to identify core populations and expedite the conservation plan, genomic DNA of the samples were processed and

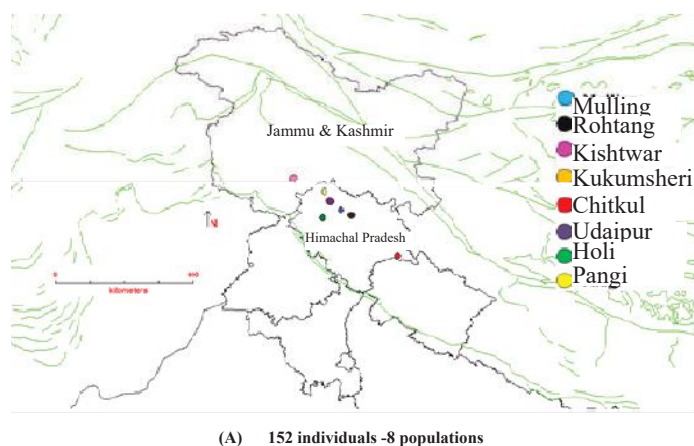
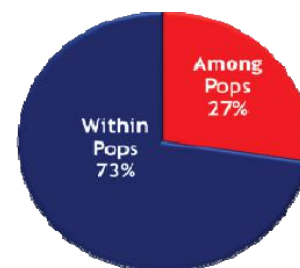

Fig. 20 A Genetic diversity characterization 152 genotypes and 8 populations of *P. kurroa*



utilized for genetic diversity assessment. A total of 5000 microsatellite markers were identified and validated in selected random genotypes of *P. hexandrum* and *P. kurroa*. Diversity characterization of 224 and 152 genotypes of the two plants were also done using SSR makers (Fig. 20A & B).

Source	df	SS	MS	Est. Var.	%	PhiPT	P-value
Among Pops	8	659.714	82.464	4.192	27%	0.275	0.001
Within Pops	146	1614.363	11.057	11.057	73%		
Total	154	2274.077		15.249	100%		



(B) SSR markers based diversity inferences

Fig. 20(B) 224 genotypes and 24 populations of *P. hexandrum*

### Ecological niche modelling for *in situ* conservation

Ecological Niche Modelling (ENM) using GPS and environmental data was done to identify suitable locations for *in situ* conservation of *P. hexandrum* and *P. kurroa* (Fig. 21 A&B).

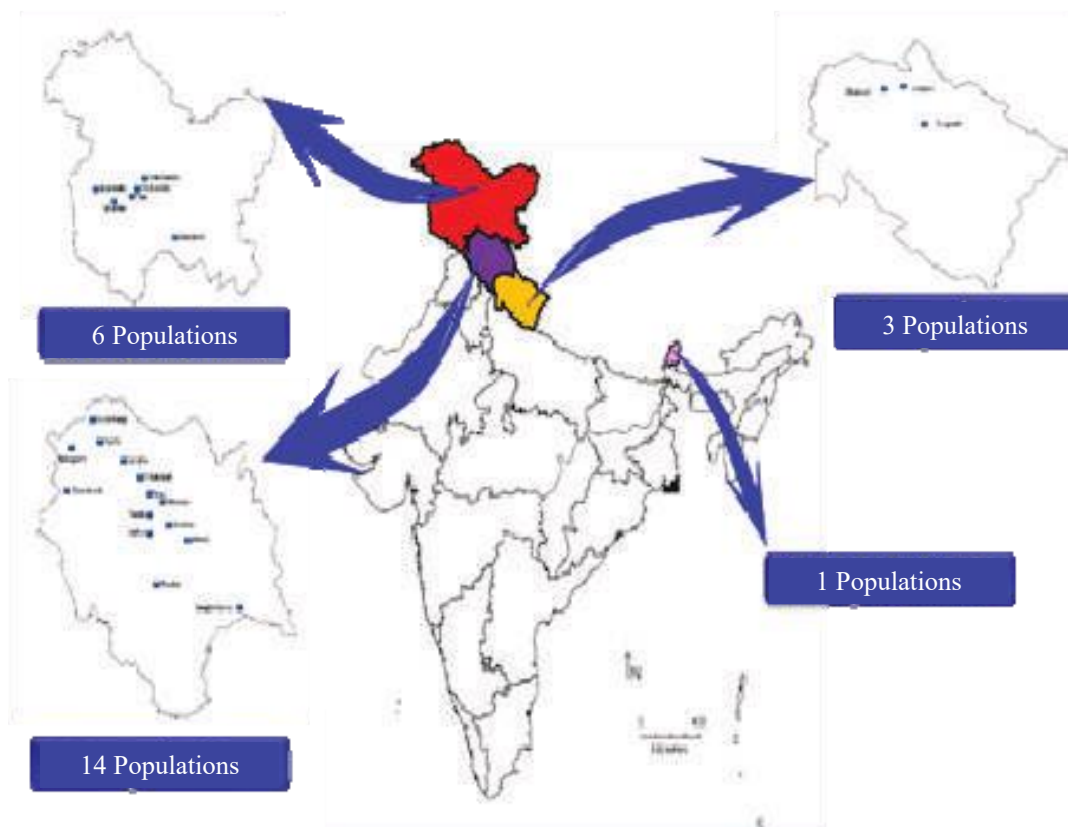

(A)

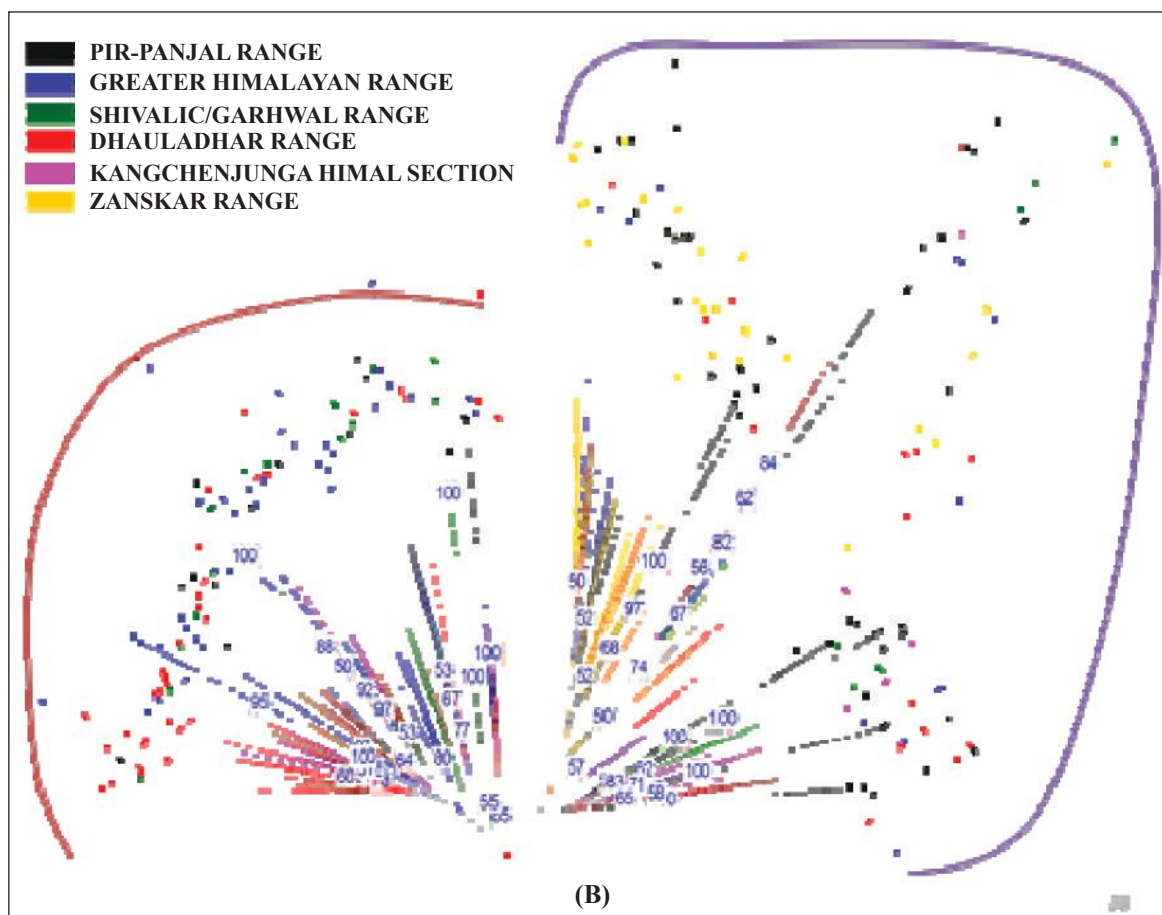

Fig. 21(A&B) Ecological Niche Modelling (ENM) for *in situ* conservation of *P. hexandrum*

### Creation of gene banks

A total of 175 genotypes (50 each of *P. hexandrum*, *P. kurroa* and *T. govianum* and 25 of *F. roylei*) having desirable phenotypic characters were collected and included in the gene bank of Centre for High Altitude Biology (CeHAB).

### Phytochemical characterization

Three pure molecules were isolated from *T. govianum*, and quality control method was developed for *P. kurroa*.

### Macro-and micropropagation for rescuing the RET plants from their RET status

About 4500 hardened tissue culture raised plantlets of *P. kurroa* were handed over to a grower for captive cultivation in Chamba region of H.P. The earlier standardized micropropagation method was employed for *P. hexandrum* and about 1500 healthy plants were raised for transfer to grower's field. Culture initiation of *F. roylei* and *T. govianum* is in progress.

## Captive cultivation for restoration of RETs for sustainable utilization

Nurseries of *P. kurroa* and *P. hexandrum* were raised and plant genetic resources were maintained at CeHAB and CSIR-IHBT for captive cultivation in farmer's field. Interactions were also conducted and trainings imparted to farmers from Chamba, Chirgaon and Shimla regions of H.P. (Fig. 22).

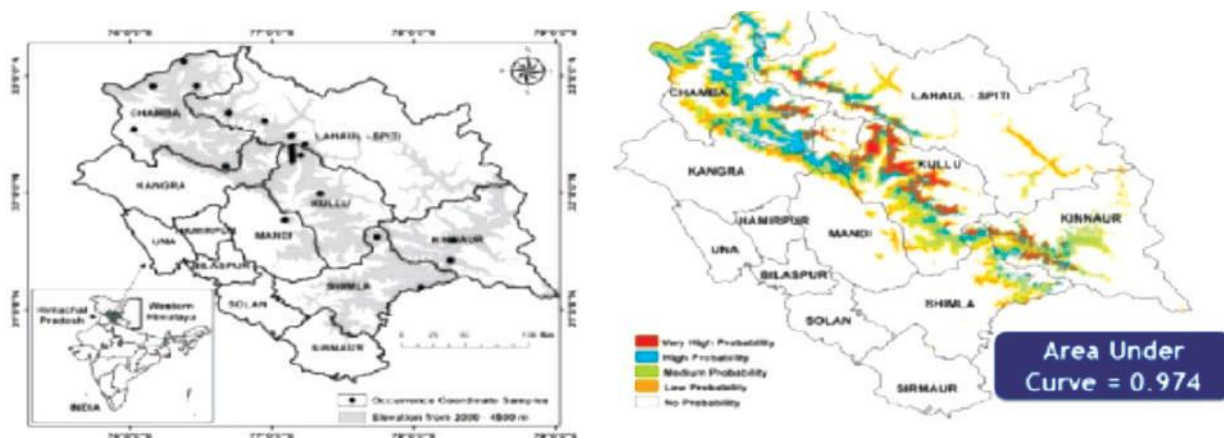

- 42 GPS coordinates recorded from locations of *P. hexandrum*
- 15 environmental variables
- Elevation & land use/land cover
- 18.76% area of HP mapped as suitable habitat for *P. hexandrum*
- Chamba region- largest probable area



Fig. 22 *P. kurroa* cultivation at Chirgaon, Shimla (H.P.)

## Stevia (*Stevia rebaudiana*)

*Stevia rebaudiana* is an alternative source of low caloric natural sweetener. Its demand is increasing rapidly. The institute is focusing to develop improved varieties and its agrotechnologies for higher productivity. Thus, 24 new lines were introduced in germplasm centre based on their agronomic traits and chemical profiling. Selected lines are under evaluation. A field experiment was also conducted to optimize time of nitrogen application in stevia. The dry leaf yield of stevia was significantly ( $P \leq 0.05$ ) influenced by time of nitrogen application with different proportions. Application of nitrogen in 3 equal doses at basal, 30<sup>th</sup> day after transplanting (DAT) and at 50 DAT registered about 24 – 37 % higher dry leaf yield compared with control and full dose of nitrogen as basal dose.

## Rural development

Approximately 1.5 crore plants of stevia were raised under open field and poly-house condition in collaboration with different private agencies, viz. M/s. Agri Natural India, Ludhiana, M/s. MS, Ludhiana, M/s. Harsh Organic Farms, Una, HP and M/s MDHP Ltd, Bastar, Chhattisgarh. A total of 70 acres land was covered under stevia cultivation.

A total of 65 people including farmers, growers and industrialist were trained for cultivation of stevia in commercial scale. Demonstration on the standardized agrotechnology of stevia cultivation was also given.

Moreover, large scale nurseries of *Valeriana jatamansi* and *Stevia rebaudiana* were also set up for promoting these crops under CSIR Mission Phytopharmaceutical (Fig. 23).



Field nursery set up in collaboration with M/s MS, Ludhiana

Field view of stevia plantation in collaboration with M/s Agri Natural India, Ludhiana

Nursery of *Valeriana jatamansi*, CSIR-IHBT

Fig. 23 Generation of planting material under CSIR Phytopharmaceutical Mission

*CSIR-Fast Track Translational Project*



## Developing L-Asparaginase with low glutaminase activity for therapeutic and food processing applications

Asparaginase therapy is an important component of acute lymphoblastic leukemia (ALL) treatment and also helps in the reduction of acrylamide (a potential carcinogen) formation in food products during high temperature heating. High glutaminase activity is responsible for associated side effects and hypersensitive reactions. Hence, new sources of this therapeutic protein which are serologically different but have efficient therapeutic effects with low or no glutaminase activity were desired.

### Important parameters unique to the development

- An efficient asparaginase enzyme from Himalayan microbial source which has wide temperature functionality.
- Asparaginase with no glutaminase activity.
- Gene for asparaginase has been cloned and successfully expressed in the *E. coli* host for high yield.
- Evaluated in normal and cancerous cell-lines with desired results.

### Major application(s)

- Pharmaceutical industries for treatment of acute lymphoblastic leukemia (ALL, childhood blood cancer) and pancreatic carcinoma.
- Food processing industries in the reduction of acrylamide (a potential carcinogen) formation during high temperature heating.

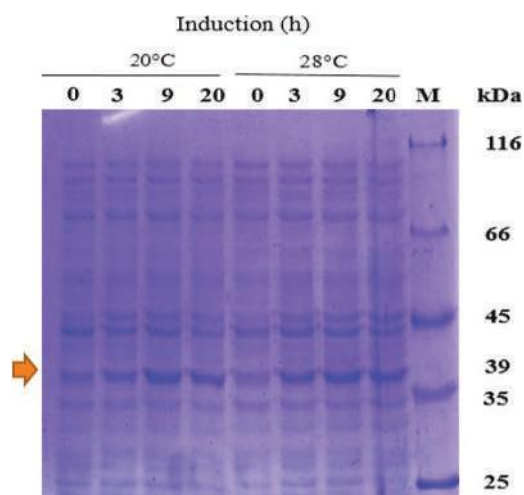

Fig. 1 Arrow indicates expression of asparaginase gene in a bacterial system

### Status of the technology development

Work has been accomplished for growth optimization in 10 L working volume of a Fermenter (23.5L capacity) for optimum protein induction. The in vivo expressed protein was purified using ion-exchange chromatography and further subjected for the biochemical characterization

of enzyme. It was shown that  $K_m$  value of our Himalayan version of L-asparaginase is 0.47mM which is much lower than the commercial L-asparaginase from *E. coli* (6.25-12.5 mM) and *Erwinia* (1.10 mM), suggesting that our enzyme has much higher specificity compared to commercial one.

To evaluate the cytotoxic effect of L-asparaginase on the cancerous cell lines, we chose eight cancerous cell lines representing four each from pancreatic and acute lymphoblastic leukemia. Our asparaginase has shown more than 85% cytotoxicity within 24 hrs for ductal carcinoma and more than 75% cytotoxicity for acute lymphoblastic leukemia, which is much better than commercial asparaginase. Our Himalayan version of asparaginase (HimAsnase™) is safe to normal cell lines. Therefore, can be potentially useful as a chemotherapeutic drug.

L-asparaginase helps in the reduction of acrylamide formation in food products during high temperature heat processing like frying, roasting, baking. It is formed from sugar and amino-acid asparagine which is naturally present in food. Acrylamide in food is considered a potential health hazard. Therefore, currently we have standardized the estimation of amino acid L-asparagine and acrylamide formation from different starch based commercial food products using UPLC-MS. A complete bioprocess for the reduction of acrylamide formation using HimAsnase will be developed for the commercial application (Fig. 2).

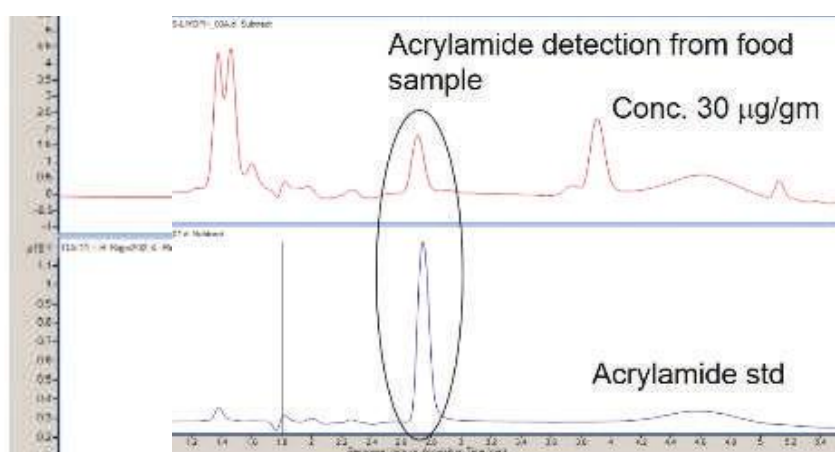

Fig. 2 Detection of acrylamide formation in processed foods using UPLC-MS/MS



*Survey, Mapping, Characterization and  
Management of Himalayan Bioresources*



The division is engaged in surveying diversity, characterizing species, mapping resources and documenting folk knowledge of the tribal communities. It generates primary field information that guides species conservation and management programmes.

### Field Survey

**Field survey and plant collection:** Seven plant surveys were planned and coordinated to different localities of Himachal Pradesh. Around 100 specimens were identified, processed and deposited in the herbarium of the institute for the reference (Table 1).

**Table 1 Detail of field tours during the year**

S. No.	Time period	Places	Purpose
1	26 May-1 June 2017	Lahaul	Field survey and ecological studies
2	10-14 June 2017	Kinnaur & Spiti	Treeline studies and bioprospecting of medicinal plants
3	23-26 June 2017	Rohtang	Ecophysiological studies
4	11-16 July 2017	Lahaul	Bioprospecting of medicinal plants and ecophysiological studies
5	27-30 July 2017	Chitkul, Kinnaur	Treeline studies
6	8-14 August 2017	Lahaul-Pangi	Treeline studies, assessment of populations of medicinal plants
7	21-24 August 2017	Rohtang	Ecophysiological studies
8	6-10 September 2017	Lahaul	-do-
9	11-13 September 2017	Rohtang	Ecophysiological studies
10	21-26 September 2017	CeHAB, Lahaul	CSIR Aroma Mission Project related targets
11	23-30 September 2017	Chitkul, Kinnaur	Treeline studies
12	28-30 September 2017	Rohtang	Ecophysiological studies
13	10-11 October 2017	Rohtang	Ecophysiological studies
14	22-23 October 2017	Rohtang	Ecophysiological studies
15	27-29 October 2017	Chitkul, Kinnaur	Treeline studies
16	1- 4 November 2017	Rohtang	Ecophysiological studies
17	3-4 December 2017	GHNP	HIMCOSTE team

## MAPPING

### Land use land cover mapping

The IRS P6 LISS IV MX image (P96 R 49) was classified following standard digital image processing techniques. Ten broad LULC classes were identified in the Chansal watershed area (Fig. 1). Among these, the largest area was under forest (55.69 %) followed by scree slopes (13.85 %), open/barren/rocky areas (9.41 %), agricultural land (8.75 %), snow (5.34 %), water bodies (3.08 %), alpine pastures (2.06 %) and built-up land (1.85 %). In case of forest, 33.31 % area was under *Pinus wallichiana*, while 3.75 % area was occupied by *Betula utilis*. Rest 18.63 % forest area constituted the Himalayan temperate mixed forest category.

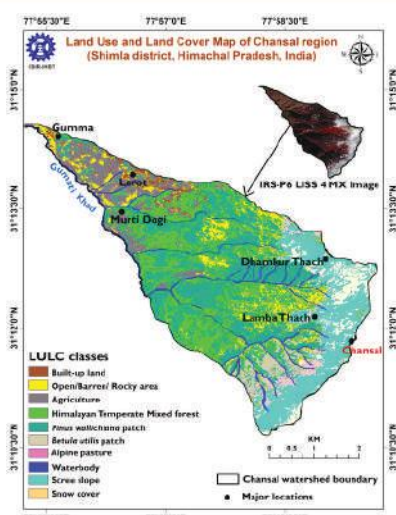

**Fig. 1 Land use land cover map of Chansal region**

### Mapping of treeline

For mapping of treeline of Chansal area (Fig. 2 & 3), Normalised Difference Vegetation Index (NDVI) was derived from LANDSAT 8 MX image (P146, R 38). The threshold value of 0.451 in the sub-alpine and alpine areas was selected for digitizing the treelines from the NDVI image. The digitized treelines were later validated with the help of web based application 'Google Earth' and GPS points collected during the field surveys. When digitized treeline was overlaid on CARTOSAT DEM, the treelines were found to range from 3350 to 3570 m asl in the region.

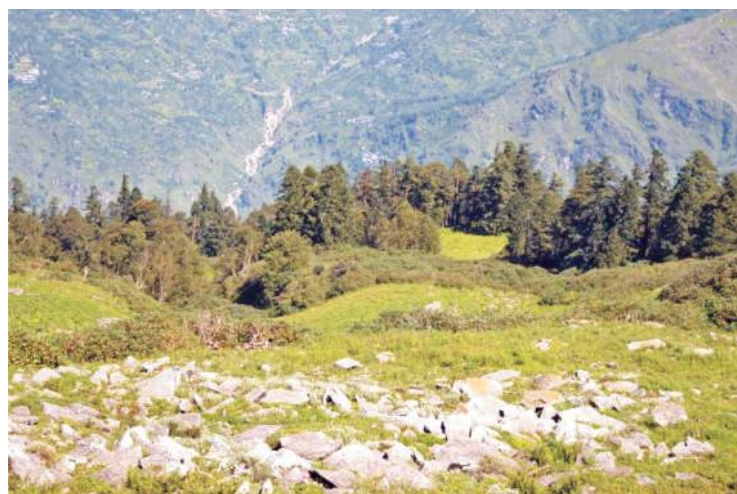

Fig. 2 A treeline view of Chansal region having *Betula utilis* and *Quercus semecarpifolia* as treeline species

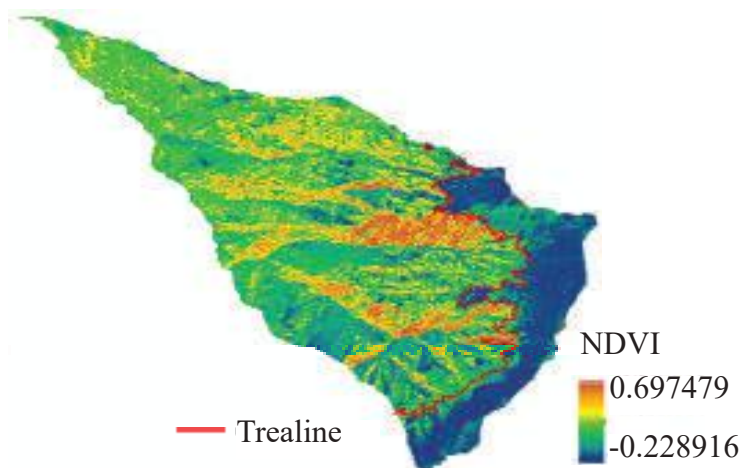

Fig. 3 NDVI image of Chansal region

### Forest fire studies

The forest fire mapping in Dharamshala and Palampur tehsil of district Kangra, H.P. was carried out using LANDSAT 8 images of 2016. Close to 9 % of the forest area in Dharamshala and 8.49 % in Palampur tehsil were found to be fire affected (Fig. 4). Forest-wise, 22.89 % of tropical forest,

13.49 % of sub-tropical forest and 0.81 % of temperate forest of the study area were affected by fire.

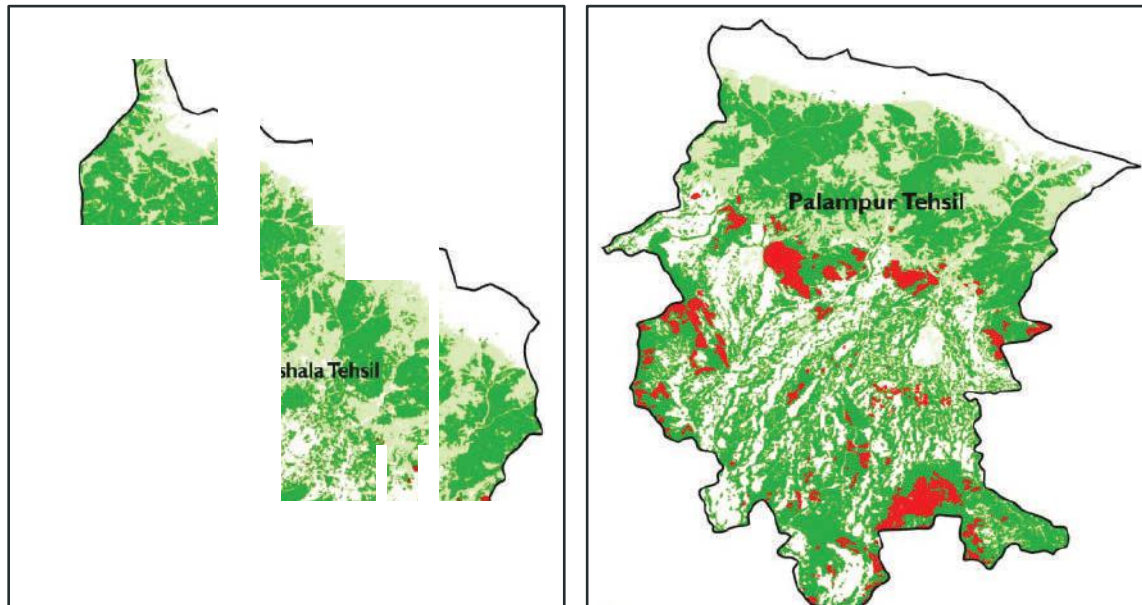

Fig. 4 Forest fire affected areas in Dharamshala and Palampur tehsils

#### Recording of hyperspectral signatures of Himalayan flora

Spectral reflectance of 48 important forest tree species of tropical, sub-tropical and temperate regions of Kangra and Chamba districts of H.P. were recorded using 350-2500 nm wavelength spectro-radiometer (Fig. 5). These recorded spectra were processed and spectral library of 48 tree species was prepared (Fig. 6).



Fig. 5 A) Locations surveyed for spectral data collection (highlighted in Green symbols); B) calibration of spectro-radiometer; C) recording of reflectance

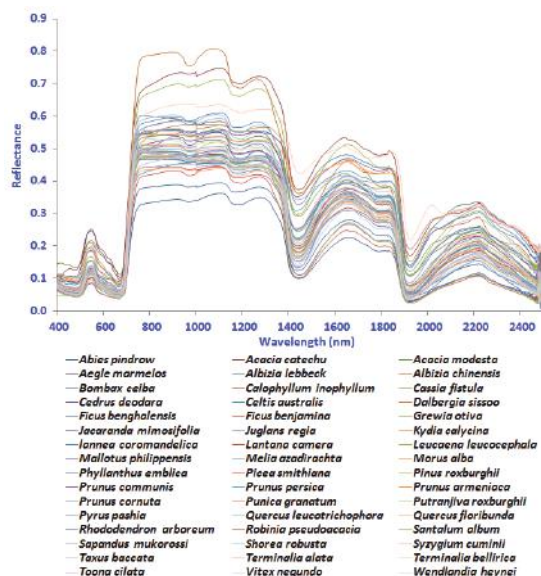
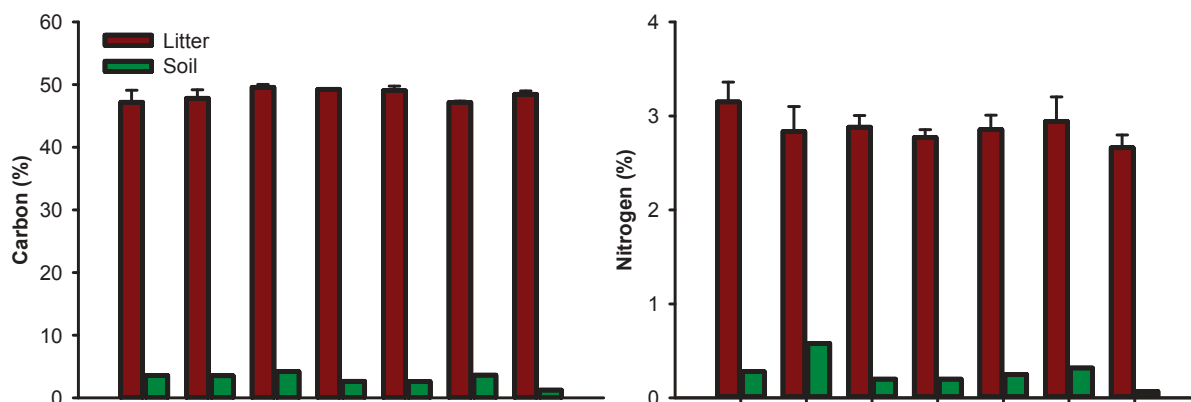

Fig. 6 Spectral signatures of 48 tree species recorded from forested regions of H.P.

### Analysis of leaf litter nutrients and its effect on soil properties of the temperate forest at Dhauladhar wildlife sanctuary

Nutrient dynamics of leaf and litter in forest ecosystems is a fundamental process in which organic matter is converted into inorganic form through de-composition and is forwarded into soils. Litter fall is a dominant pathway by which nutrients, especially nitrogen (N) and phosphorus (P) return to the soil. The present study analysed nutrient concentration of litter and its release into the soil. Further, the study compared litter nutrient release with soil nutrient patterns in different sites at Dhauladhar Wildlife Sanctuary which are dominated by different tree species (*Quercus semecarpifolia*, *Picea smithiana* and *Taxus baccata*). The C:N ratio in the litter samples ranged from 16.78 to 18.56% across the site, whereas, in the soils, varied from 6.06 to 17.28% (Fig. 7). On an average, ratio of carbon and nitrogen was approximately 2.4 times more in litter than in soil. Further, the value of total phosphorus in litter was approximately three times more than in the soil.



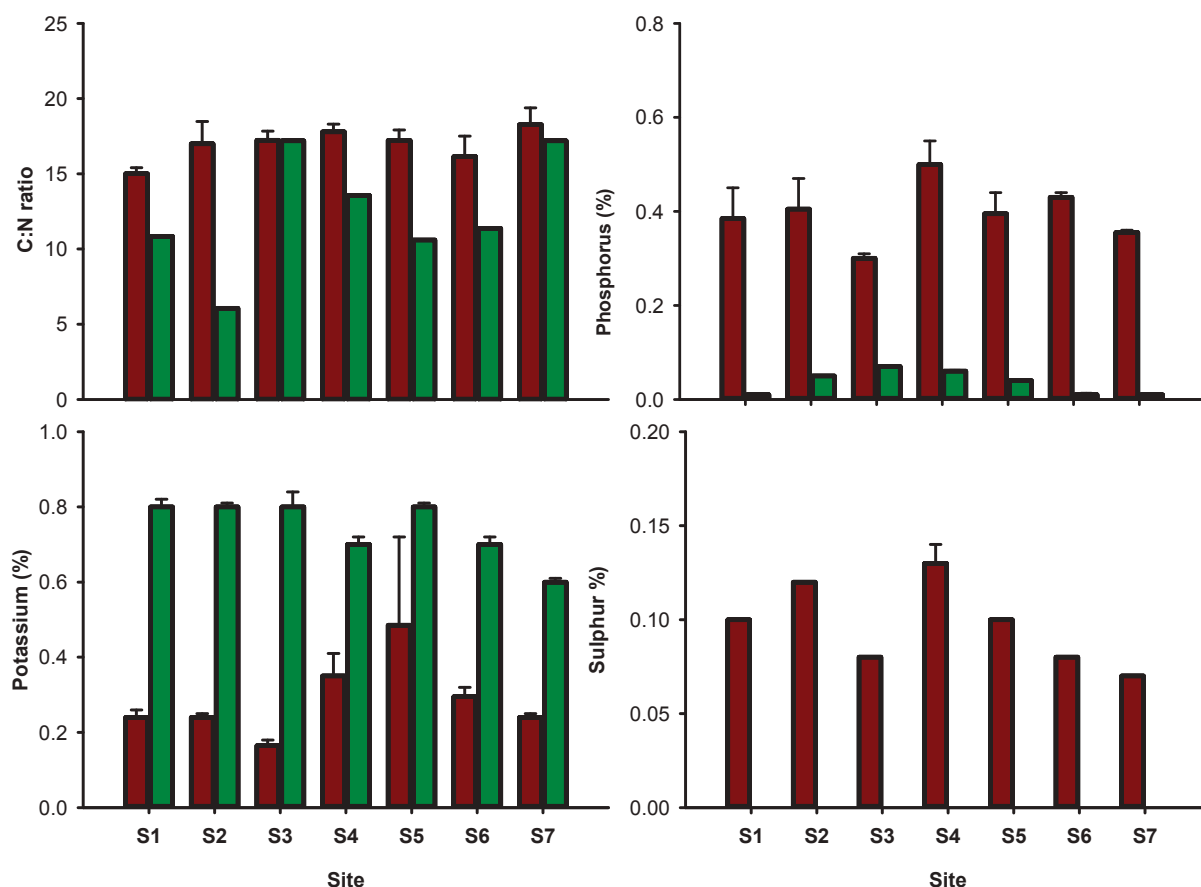

Fig. 7 Site wise variations in different components of litter and soil at Dhauladhar wildlife sanctuary

### Ethnobotanical studies

Studies were carried out among the Gujjars and Pangwalis inhabiting Chamba district of H.P. About 55 local knowledge holders were interviewed to gather information on different aspects of traditional knowledge systems. Close to 135 plants species were reported to be used for health care, edible, and socio-religious purposes.

### Assessing bio-indicator responses and performance of plant species along a vehicular pollution gradient in western Himalaya

Loss of green cover and increasing pollution calls for screening of pollution tolerant species that can be integrated into plantation drives. Recognizing this, bio-indicator responses and performance of commonly occurring plant species was assessed in highly polluted (HP), moderately polluted (MP) and least polluted (LP) sites. The sites were categorized based on the distance from road. Leaves of 26 commonly occurring plant species were collected and analyzed for dust accumulation, total chlorophyll, relative water content (RWC), ascorbic acid, and pH using standard protocols. Later, assessment of Air Pollution Tolerance Index (APTI) and Anticipated Performance Indices (API) was carried out. It was revealed that pH, RWC and total chlorophyll increased with decreasing

pollution while ascorbic acid increased with increasing pollution. *Grevillea robusta* was classified as tolerant species and scored significantly higher values i.e. 21.06, 21.19, and 19.61 in LP, MP and H.P. sites, respectively. *Quercus floribunda* (68.75 %), *Juglans regia* (68.7%), and *T. ciliata* (62.50 %) were good performers in H.P. sites. *Acer caesium*, *Betula utilis*, *Morus alba* that had low API scores (43.75 %) were predicted as poor performers. Thus, *G. robusta*, *Q. floribunda*, *J. regia*, *T. ciliata*, and *F. carica* can be integrated into plantations drives and urban greening programmes.

### Wild edible plant consumption

Wild edible plants (WEPs) consumption and their trends were documented amongst the *Bhangalis* residing in Chhota Bhangal, district Kangra (H.P.) (Fig. 8). Fifty plant species were used by the local people for edible purposes under six WEP categories (Fig. 9). With reference to trends, almost 50% of the respondents revealed that they still continue to use WEP while 36% reported trends of declining use as compared to 5-10 years back. Close to 10% respondents do not consume WEP now. Taste and aroma were the major socio-cultural reasons behind using WEP, while modernization and changing lifestyle were the main reasons behind declining use of WEP.

During the reporting period, 12 surveys were carried out to the different localities of Himachal Pradesh (H.P.). During these surveys, sampling of plant resources and resource use patterns were documented. A concise account is presented below.



Fig. 8 Rhododendron flowers for sale in market

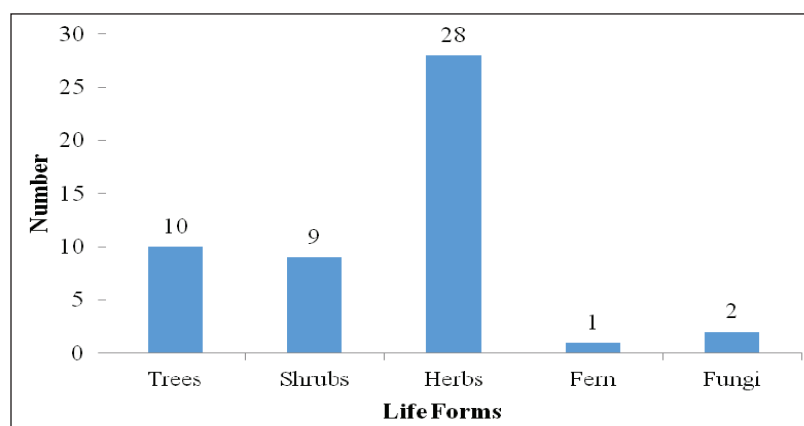

Fig. 9 Life form categorization of wild edible plants used



### Altitude wise richness of alien plant species

The spread of alien plant species in bio-rich mountains has conservation implications that necessitate their documentation across altitudes. The present study analyzed patterns of alien species richness along gradient of altitude (Fig. 10). Alien species richness was found to be maximum in the 1000-1100 m band, and significantly varied along the altitudinal gradient. Their distribution was in contrast to the native species distribution whose maximum richness is reported at mid-altitudes (2000-2500 m). Interestingly, as is the case with native species, members of Asteraceae, Fabaceae, and Poaceae dominated the alien flora (Table 2).

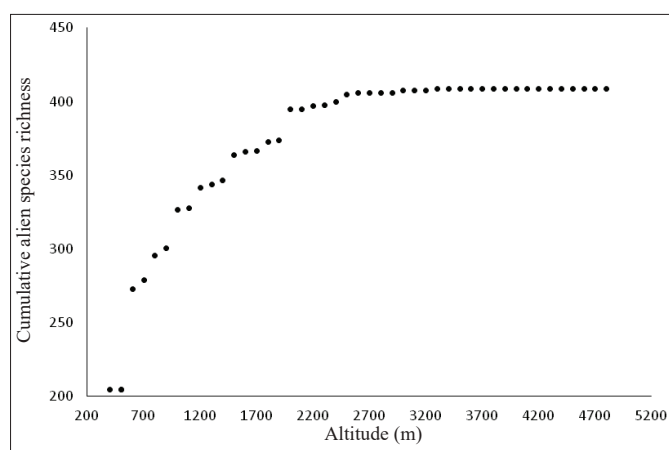

Fig. 10 Cumulative alien species richness across altitudinal gradients

Table 2 Characteristics of different types of medicinal plant collectors

	Professional	Opportunist	User
<b>View</b>	Commodity of trade	Additional Income	Drug/ Cure
<b>Approach</b>	Maximize economic returns	Leisure based club with other activity	Need based
<b>Coverage</b>	Large spatial spread, often outside village jurisdiction	Limited coverage guided by associated primary activity	Mostly around villages
<b>Efforts</b>	Dedicated	Limited	Dedicated
<b>Implications</b>	Heavy impact, local extinction	Limited impact	Minimal impact
<b>Collection</b>	During peak growing season	When opportunity strikes	When required
<b>Client</b>	Traders	Middle men	Self (Household need)
<b>Awareness</b>	Aware of market demand	Limited and follow the professional	Use and conservation
<b>Concern</b>	Little	Concerned	Highly concerned

	<b>Professional</b>	<b>Opportunist</b>	<b>User</b>
<b>Gender</b>	Male	Generally male, occasionally female	Male and female
<b>Age group</b>	16-40 Years	30-60 years	50-70 years
<b>Value Chain</b>	The national market	The local market	The local healer

### **Medicinal plant collectors**

Medicinal plant collection from Himalaya is a key conservation issue that involves extraction of plants from wild by collectors. Three types of collectors namely professional, opportunist, and user have been identified. Of the three categories, only the users consume the plants at source while the other two are involved in trade. This is clearly reflected in the difference in their value chain. While professionals and opportunists are buyer driven, the user is producer driven (Table 1). A conservation and management policy focusing on plants and also diversity of people is the need of the hour.

*Conservation of Rare, Endangered and  
Threatened Plant Species*



## Conservation of RET taxa

Besides maintaining 15 RET taxa, 12 additional RET species were collected from different phyto-geographical zones of H.P. and successfully introduced in the botanical garden of the institute. These included *Saussurea costus*, *Jasminum parkeri*, *Hyoscyamus niger*, *Taxus baccata*, *Rauvolfia serpentina*, and *Valeriana jatamansi* (Fig. 1).



Vegetative (A) and flowering (B) stages of *Saussurea costus*



Flowering (A) and Fruiting (B) stages of *Jasminum parkeri*



Nurseries of *Valeriana jatamansi* (A) and (B) *Hyoscyamus nigra* under polyhouse condition

Fig. 1 Conserving rare and threatened plants at Palampur

## Micropropagation

### *Malaxis acuminata* (Jivak)

*M. acuminata* is an endangered terrestrial orchid of Himalayas popularly used to treat various chronic ailments. The plant is facing the risk of habitat destruction and eventually extinction because of its extensive use in traditional systems of medicine including “Ayurveda”. Moreover, *M. acuminata* has extremely poor and slow germination (<3%) due to the lack endosperm. Hence, work on micropropagation of the plants was initiated for rehabilitation and sustainable utilization. Seeds of pods collected from different geographical locations (Fig. 2 A-B) were inoculated on Murashige and Skoog (MS) medium containing 1.0 mg/L *meta*-topolin (*mT*), an aromatic cytokinin, 0.5 mg/L indole butyric acid (IBA) and the phenolic elicitor-phloroglucinol. A high frequency of germination was recorded, and well-developed plantlets within 7-8 months under *in vitro* conditions. Adventitious shoots developed and protocorm like bodies (PLB) proliferated on medium containing *mT* and NAA (Fig. 2 C-G). Successful branched rooting was achieved on medium containing IBA. The plants were also hardened, acclimatized successfully and are now being maintained at CSIR-IHBT (Fig. 2 H-I). The time span for total cycle of propagation was also reduced to approximately seven months under *in vitro* conditions as opposed to 18 months under natural conditions.

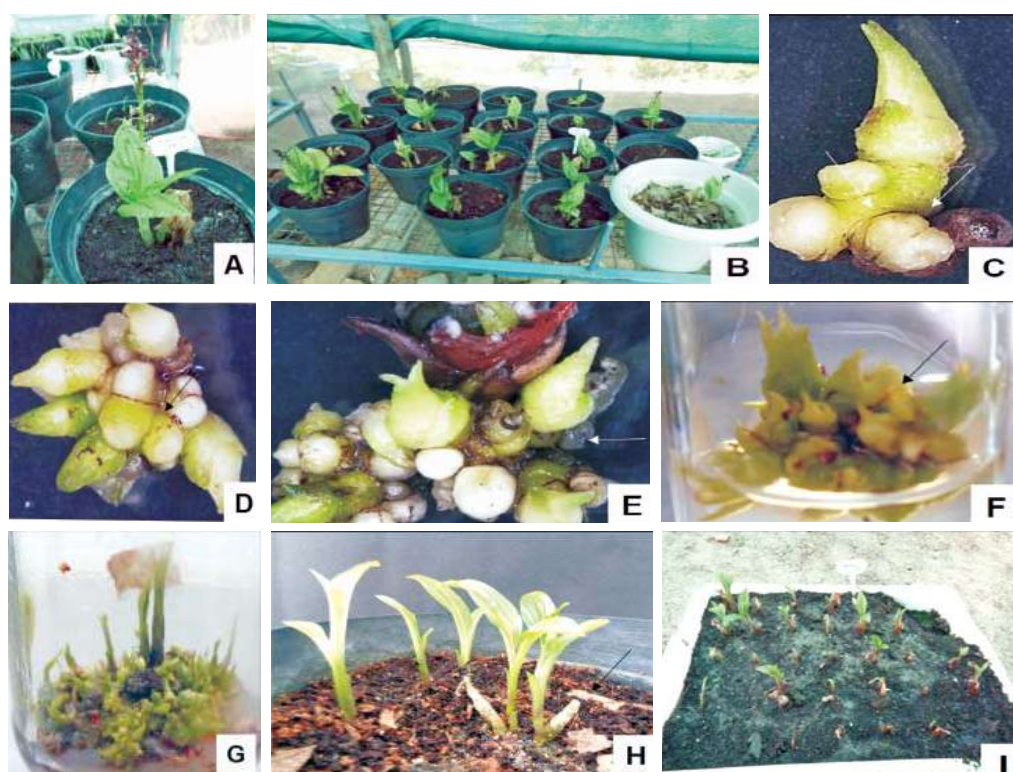

**Fig. 2 A-I** *Malaxis acuminata* (A) wild plants in flowering condition (B) accessions maintained in the greenhouse (C) initiation of cultures from the pseudobulb segments on medium containing 1.0 mg/l *mT* + 0.5 mg/l NAA (D) proliferation of protocorm like bodies after 15 days (E) shoot-bud initiation after 3 weeks of culture (F) shoot bud multiplication and proliferation (G) plantlet development and root induction (H) plantlets after primary hardening (I) gardened plantlets after 45 days under greenhouse conditions

***Dactylorhiza hatagirea* (Salam Panja)**

*D. hatagirea*, an orchid endemic to north-western Himalayas is a medicinal plant of family Orchidaceae. Its main medicinal properties are due to the presence of a glucoside, dactylorhin in the tuber. *D. hatagirea* is generally considered as high valued medicinal herb as the market value of its dry tubers are in the range of Rs. 3,000-3,200 /kg. Despite the potential value of dactylorhin, only limited amount of dactylorhin can be extracted from the tubers.

Young and mature rooted plantlets were procured from natural habitats of Lahaul & Spiti and Leh districts of H.P. and J&K, States respectively. A series of combinations of media and growth regulators were used to induce callus from tubers and roots. Thiadiazuron (TDZ), facilitated significant callus induction as compared to other phytohormones. The frequency of callus obtained from field grown tubers/roots was very less. Therefore, *in-vitro* tuber explants were also used for callus induction. The callus induced from different explants i.e. tubers and roots were multiplied on optimized medium. The proliferated callus was then suspended in liquid culture for further observations such as biomass and metabolite content (Fig. 3 A-G).

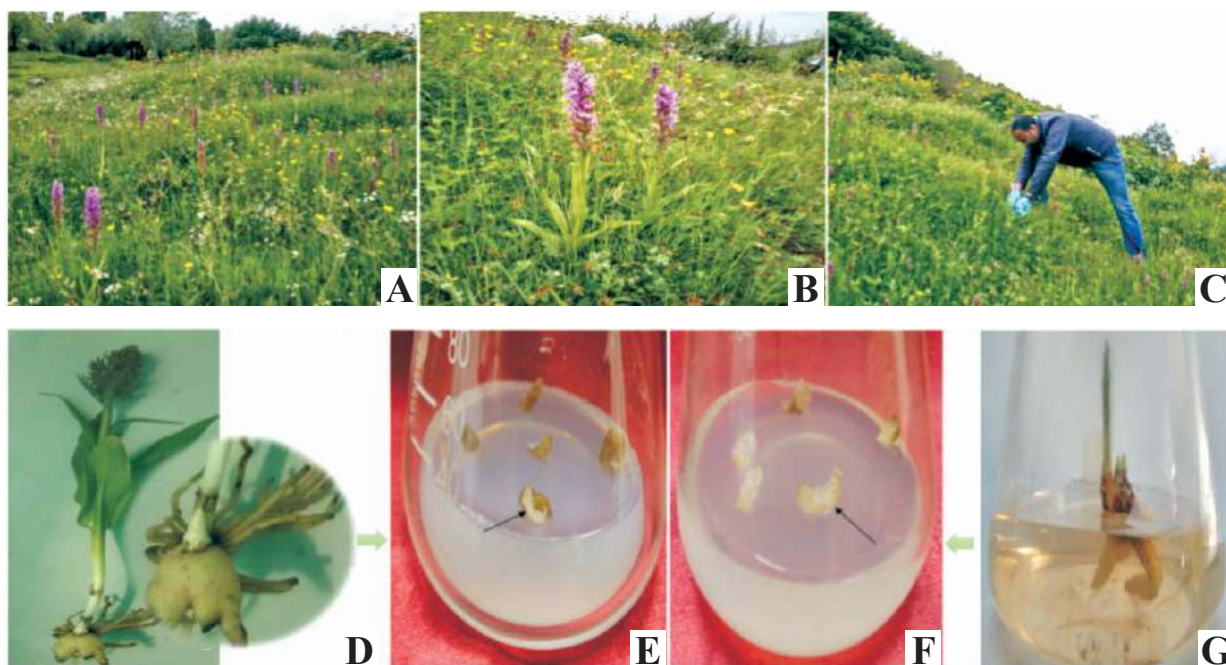
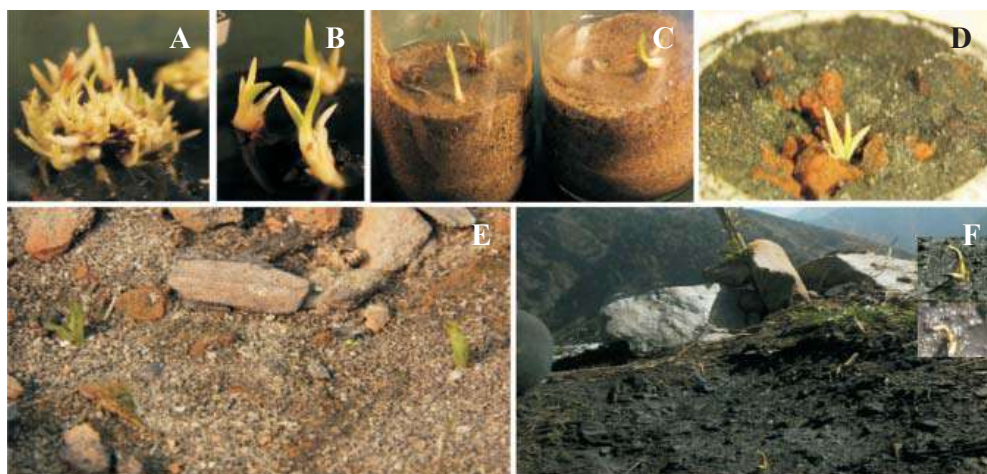

Fig. 3 A-G (A & B) *Dactylorhiza hatagirea* population (plants with violet flowers) in natural habitat at Keylong, H.P. (C) collection of plants (D) plant with inflorescence, leaves, stem, tuber and roots (E) callus induction from field grown tubers/roots (F) callus induction from *in-vitro* tubers (G) *in-vitro* propagated plant with shoots and tuber/roots

**Rehabilitation in natural habitat**

In continuation to our previous studies on rehabilitation of *in vitro* plantlets of *D. hatageria*, five different accessions were raised through multiplication of protocorm like bodies (PLBs). The plantlets were transferred to greenhouse for hardening. Hardening percent response was

improved to about 90% by pre-hardening. The percent survival under *in vitro* conditions was about 85% in jars containing sand moistened with distilled water. The hardened plants were handed over to a collector of medicinal plants from wild. The plants were finally established in the collector's field at natural habitat, Bharmour, Chamba, H.P. (Fig. 4).



**Fig. 4** Micropropagation of *D. hatagirea* (A) *in vitro* multiplication of PLBs (B) *in vitro* raised plantlets (C) pre-hardening in sand moistened with distilled water (C) hardened plants under green house condition (E-F) *in vitro* raised plantlets at natural habitat

### Understanding the response to disturbances

Among various plant groups, food deceptive terrestrial orchids have high extinction risk. *D. hatagirea* is a food deceptive orchid endemic to Himalaya. Its population faces extinction risks due to ruthless extraction of its tubers because of medicinal properties (aphrodisiac, for wound healing *etc.*) and habitat specificity. Twenty-three populations representing heavily devastated (HD) and lightly devastated (LD) threat categories were studied to analyse the effect of disturbances on its vegetative and reproductive performance.

Heavily devastated populations were found to have smaller population sizes, but showed increase in plant height, specific leaf area, leaf N and higher reproductive success. This could be a key strategy of food deceptive orchid species under threat for population persistence. Therefore, small populations of food deceptive orchid species tend to reduce probability of population extinction and can recover rapidly if conserved on time (Fig. 5).



**Fig. 5** Lightly devastated population and heavily devastated population of *D. hatagirea*



***Trillium govanianum* (Nag chhatri)**

*T. govanianum* (Nag chhatri or Teen Patras or Satvas) is an important medicinal perennial herb of north western Himalayas. It is found at elevations ranging from 2700-4000 m asl. It is a critically threatened plant species. Its rhizomes contain trillaridin, which on hydrolysis yields diosgenin. It is used in the preparation of contraceptives along with steroidal and sex hormones. Owing to its rising demand in the international markets, it has suffered from over-exploitation and rapid depletion of natural populations. Therefore, in order to conserve this species, cultures were initiated on solid as well as liquid half strength media containing 5 mg/L BAP and 1 mg/L NAA along with other plant growth regulators. Different temperature ranges and variation in the pH were also standardized (Fig. 6 A-D).

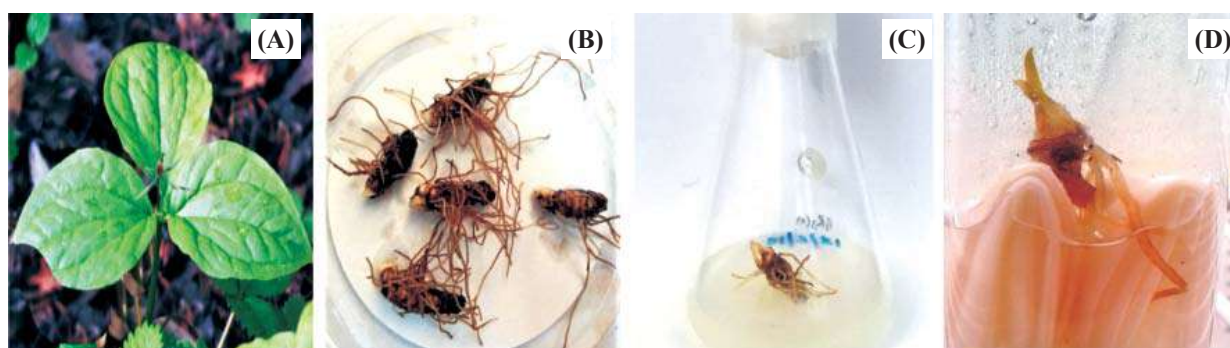

Fig. 6 (A) *Trillium govanianum* plant (B) sterile rhizome buds (C-D) aseptic cultures on (C) solid medium (D) liquid medium

***Podophyllum hexandrum* (Ban Kakri)**

In order to raise plantlets for transfer to natural habitat, rhizome buds were used as explants for *in vitro* propagation of *P. hexandrum*, (Fig. 7). Seeds were also sown in pots containing sand for macropropagation (Fig. 8).

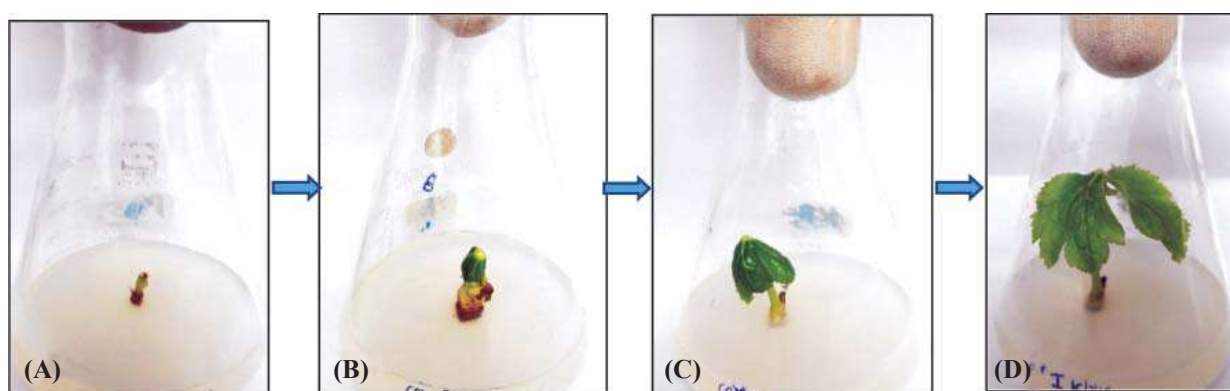

Fig. 7 Micropropagation of *P. hexandrum* (A) emergence of rhizome bud (B) shoot initiation (after 7 days) (C) shoots regeneration after 14 days (D) 30 days old plantlet

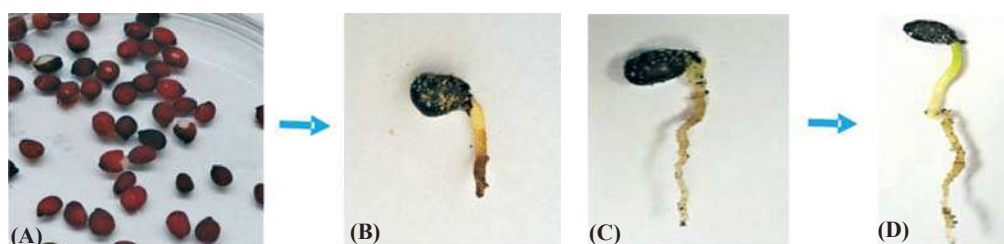

Fig. 8 Macropropagation of *Podophyllum hexandrum* (A) imbibed seeds, (B) germinated seedling in soil (after 8 weeks), (C-D) seedling growth after (C) 9 weeks (D) 10 weeks

### *Picrorhiza kurroa* (Kutki)

#### Callus culture establishment

*P. kurroa* is an endangered medicinal plant of western Himalaya widely acclaimed for its hepatoprotective and antidiabetic properties. Iridoid glycosides are the main constituents of *P. kurroa* and are commonly known as picrosides. Picrosides present in the roots, rhizomes and leaves are used to cure hepatic disorders, gastric troubles, anemia, asthma and pregnancy related problem. Presently, *P. kurroa* is enlisted as endangered.

Therefore, aseptic callus cultures of *P. kurroa* were established for the *in vitro* production and enhancement of picrosides under different growth conditions (Fig. 9).

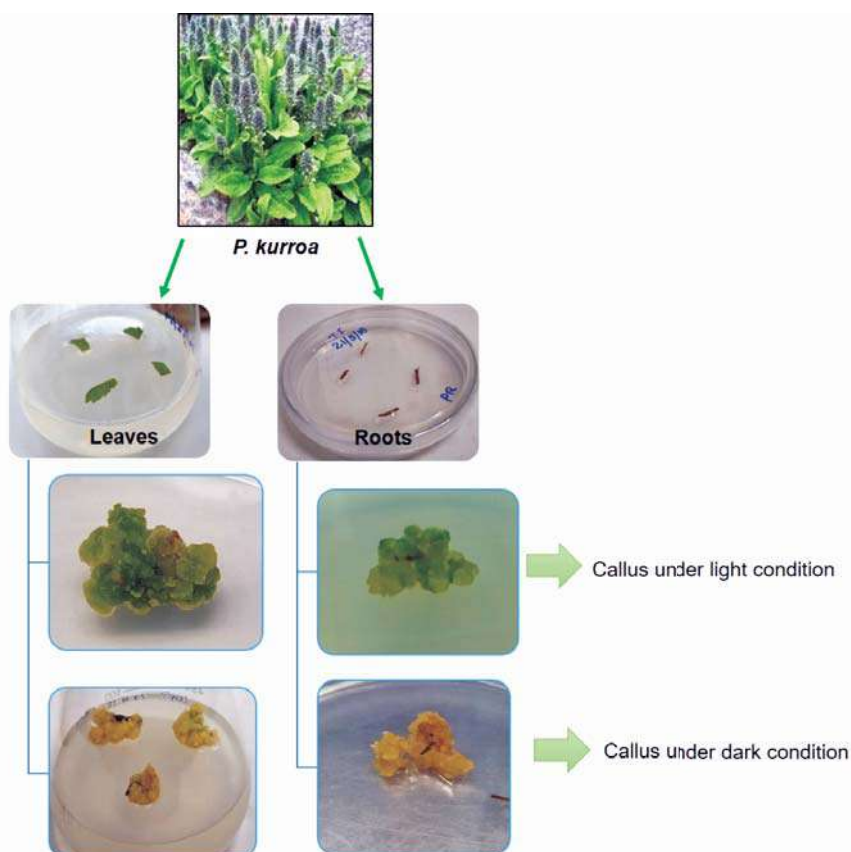
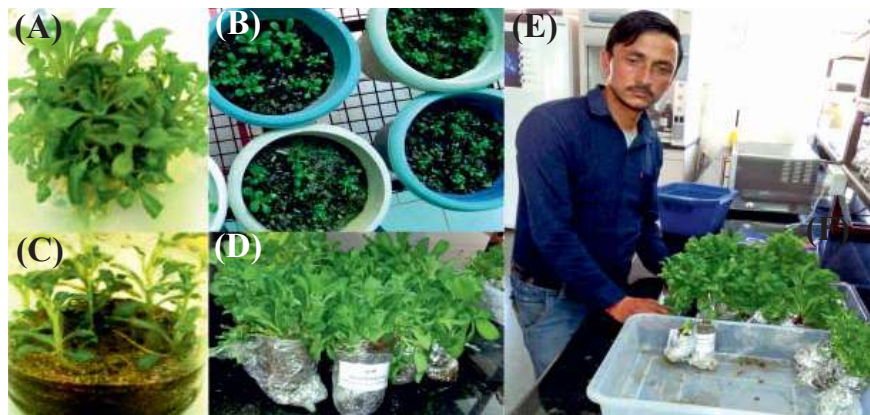

Fig. 9 Callus induction from leaves and roots explants in *Picrorhiza kurroa*

***Picrorhiza kurroa***

In continuation to previous work on transfer of *in vitro* raised plantlets to a medicinal plant collector for establishment in natural habitat, micropropagation of the plant was scaled-up in the current year. A fresh lot of around 15,000 tissue-cultured plantlets were raised and about 2500 hardened TC raised plants were supplied to the collector for rehabilitation under natural habitat. The plants showed healthy growth and two fold multiplication rate under natural habitat (Fig. 10).

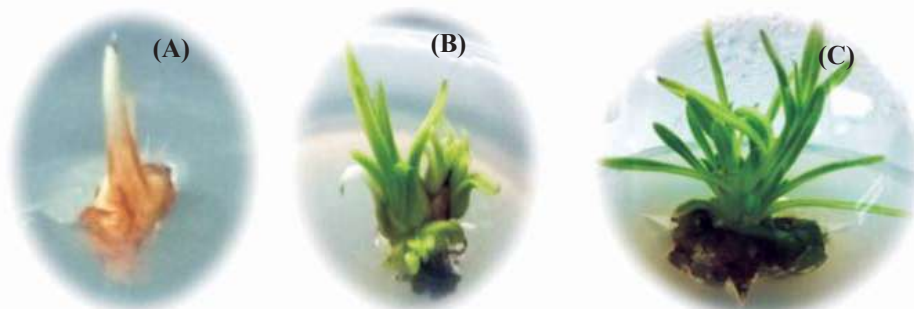

**Fig. 10** Micropropagation of *P. kurroa* (A) *in vitro* shoot multiplication, (B-C) hardening under greenhouse condition, (D-E) hardened *in vitro* raised plants ready for transfer to natural habitat

***Arnebia euchroma* (Ratanjot)**

*Arnebia euchroma* is a critically endangered medicinal plant (3000-4200 m) of western Himalaya. The roots of the plants are rich source of naphthaquinone pigments. The plant has been overexploited for its medicinal properties such as wound healing, anti-inflammatory, antimicrobial properties and also used as red colored natural dye for coloring silk, cosmetics and as food additive.

In continuation to previous work on the production of naphthoquinone red pigments from critically endangered *Arnebia* species, *in vitro* cultures were established from rhizome buds. The explants were cultured on optimized Murashige and Skoog medium supplemented with thidiazuron (Fig. 11).



**Fig. 11** *In vitro* shoot cultures of *A. benthamii* (A) rhizome bud inoculated on medium (B) shoot culture after 3 weeks and (C) multiplication after five weeks

In addition, efforts were made to develop adventitious root cultures (Fig. 12).

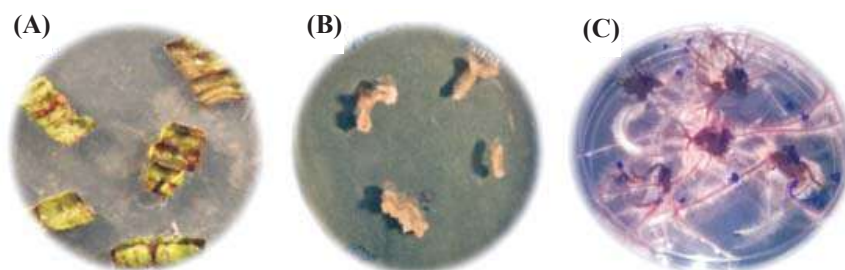

Fig. 12 Adventitious root induction from leaf explants of *A. benthamii* (A) leaf explant inoculated on MS medium (B-C) adventitious root induction (B) after 2 weeks (C) after 4 weeks

For sequential scale up, the biomass yield at different scales was optimized in shake flasks. The cell biomass was found to decrease with increase in vessel volume (Table 1 and Fig. 13).

Table 1 Biomass yield and growth index of *Arnebia benthamii* cell suspension culture

Vessel size (ml)	Inoculum density (%)	Fresh weight (g/l)	Growth Index
250	10	640±21	5.4
500	10	500±16	4
1000	10	425±26	3.25
2000	10	365±37	2.65

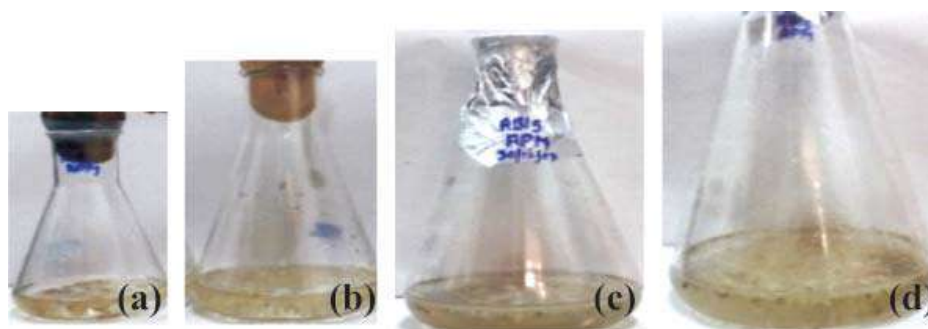

Fig. 13 Cell culture in shake flasks of different volumes (a) 250 ml (b) 500 ml (c) 1000 ml (d) 2000 ml

### *Rhodiola imbricata* (Rose root, arctic or golden root or shrolo)

*R. imbricata* is an important medicinal plant of the high altitude region of Indian trans-Himalaya. It is used in the stimulation of the nervous system, enhancing work performance, eliminating fatigue, preventing high-altitude sickness and as anti-depressant. Chemical constituents such as salidroside (rhodiololides), rosavins, and P-tyrosol are predominantly present in the roots. Since the roots are being heavily exploited from the wild, the natural resources are dwindling rapidly. In this regard, micropropagation and hardening of the plant was targeted in the current year for maintenance of germplasm and conservation (Fig. 14).

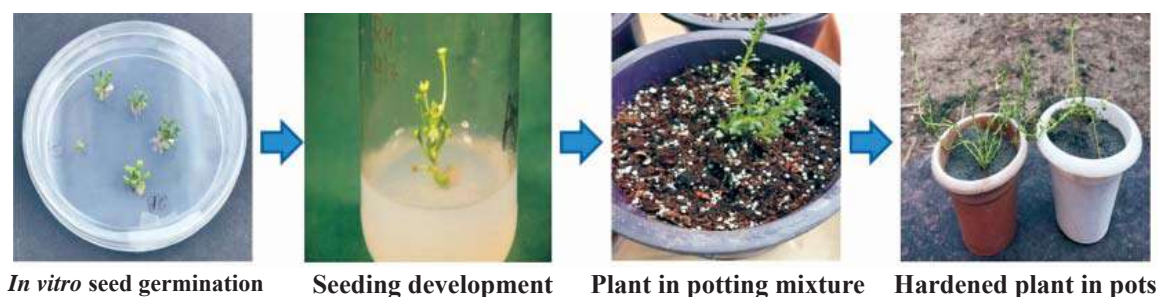

Fig. 14 Micropropagation of *R. imbricata*

### Development of callus culture

Callus was induced from leaf explants of *R. imbricata*. For this MS medium containing different combinations of NAA and TDZ at 0.5 to 3.0 mg/L was used; but 1.0 mg/L NAA and 1.0 mg/L TDZ supported maximum callus proliferation. The aim was to produce high metabolite yielding cell line of this less explored medicinal plant and scale it up at shake flask level (Fig. 15).

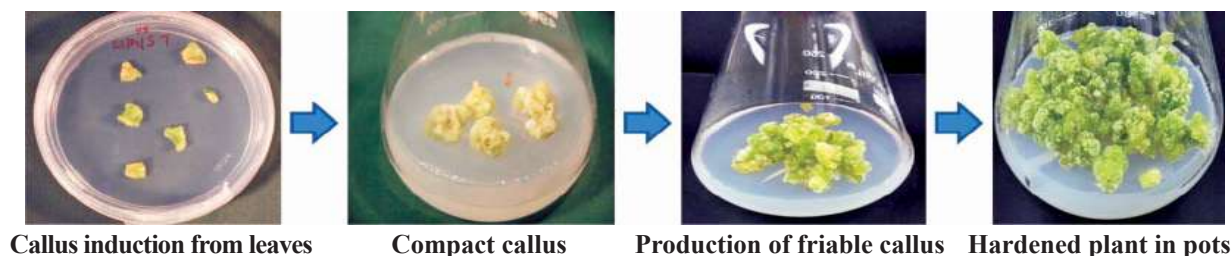

Fig. 15 Establishment of callus culture of *R. imbricata*



*Bioprospection and Characterization of  
Himalayan Bioresources*





## MICROBIOLOGY

### Exploring Himalayan microbes for industrial enzymes and biopolymers

Himalayas offer unique niches for the discovery of microorganisms having novel enzymes with distinctive properties. Therefore, in previous years, work on systematic sampling and isolation of microbes from Indian Himalayan Regions (IHR) were initiated. A repository of microbial wealth was created for biotechnological applications in ligninocellulose degradation, synthesis of biopolymers and therapeutics. In the continuation to this activity, in the current year, the bacterial diversity of Pangi-Chamba Himalayan region of (H.P.) was explored for potential cellulose degraders. A total of 454 pure bacterial isolates were obtained from diverse sites of the region, and 111 isolates were further selected for 16S rDNA characterization based on ARDRA grouping. The identified bacteria belonged to 28 genera representing four phyla (Fig. 1). Screening for cellulose degradation ability on carboxymethyl cellulose plates revealed that 70.92% of bacteria were cellulolytic. These included *Arthrobacter*, *Paenibacillus*, *Chryseobacterium*, *Pedobacter*, *Streptomyces*, *Agromyces*, *Flavobacterium* and *Pseudomonas* with high cellulolytic functionality at wide range of pH and temperatures not reported earlier (Table 1). The bacteria can be employed for efficient pretreatment of lignocellulosic biomass.

**Table 1 Potential bacterial isolates (n = 9) with a high cellulose hydrolytic zone ratio and hydrolytic capacity (HC) values for cellulase activity**

Isolate Code	Acc. No	Closest match	Ratio	HC values
PCH26	KY628844	<i>Agromyces cerinus</i> subsp. <i>nitratus</i> ATCC 51763(T)	4.5	3.5
PCH60	KY628878	<i>Paenibacillus xylanexedens</i> B22a(T)	4.5	3.5
PCH74	KY628892	<i>Flavobacterium aquidurens</i> WB-1.1.56(T)	9.0	8.0
PCH75	KY628893	<i>Chryseobacterium piperi</i> CTM(T)	5.0	4.0
PCH81	KY628899	<i>Flavobacterium frigidimaris</i> KUC-1 (T)	6.25	5.25
PCH82	KY628900	<i>Paenibacillus amylolyticus</i> NRRL NRS-290(T)	5.5	4.5
PCH83	KY628901	<i>Exiguobacterium antarcticum</i> DSM 14480 (T)	4.33	3.33
PCH106	KY628924	<i>Bacillus licheniformis</i> ATCC 14580(T)	5.0	4.0
PCH113	KY628931	<i>Geobacillus thermoleovorans</i> KCTC 3570 (T)	6.0	5.0

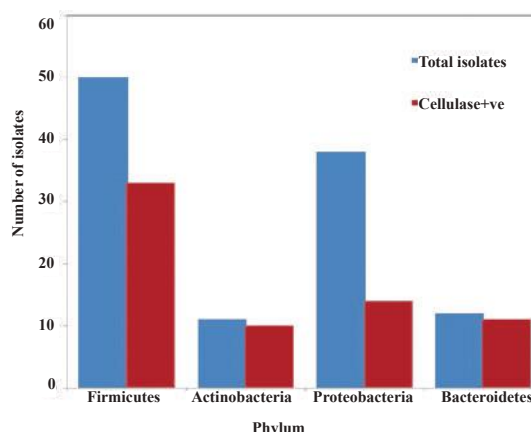

**Fig. 1 Comparative analysis of cellulase-positive isolates in respective phylum**

## Bioplastic potential of diverse bacterial communities along altitude gradient of Pangi-Chamba trans-Himalayan region

In the current year, a total of 411 bacteria were isolated from different altitudinal gradients of Pangi-Chamba trans-Himalayan region (Fig. 2). From among these, 70 were characterized for potential polyhydroxyalkanoate (PHA) producers at the molecular level. The most abundant phylum for PHA synthesis was *Proteobacteria* (73%) followed by *Actinobacteria* (11%), *Firmicutes* (10%) and *Bacteroidetes* (6%). At the genus level, *Pseudomonas* and *Janthino bacterium* were dominant. A few genera such as *Collimonas*, *Pseudarthrobacter* and *Paenarthrobacter* capable of synthesizing PHA were also identified and confirmed using GC-MS (Table 2). Dominance of PHA-positive bacteria at high altitudes of Himalaya suggests a vital role of PHA in bacterial adaptation and survival.

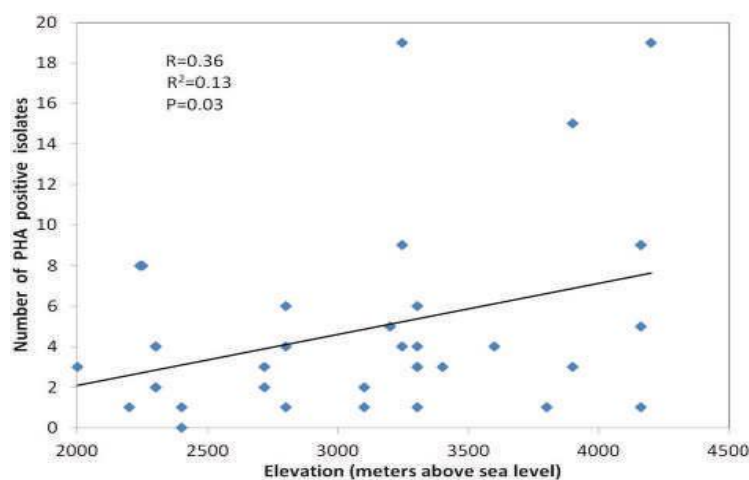

Fig. 2 Abundance of PHA-positive bacterial isolates along the altitudinal (masl) gradients at Pangi-Chamba region. Pearson correlation coefficient (R) between sampling altitude and PHA-positive isolates. \*R-squared ( $R^2$ ) and probability (P) values

Table 2 Quantitative analysis of representative bacterial isolates for cell biomass, PHA content and status of monomer composition of PHA

S. No.	Isolates	PHA production time (h)	Dry cell weight (mgmL <sup>-1</sup> )	PHA (mgmL <sup>-1</sup> )	PHA content (% dry cell weight)	PHA monomer
1	<i>Pseudomonas</i> sp. PCH123	48	1.02	0.42	41	HO
2	<i>Janthinobacterium</i> sp. PCH140	48	0.63	0.23	36.5	HTD
3	<i>Arthrobacter</i> sp. PCH145	48	0.65	0.1	15	HTD
4	<i>Rahnella</i> sp. PCH160	48	1.33	0.29	21.2	HB
5	<i>Collimonas</i> sp. PCH180	72	1.4	0.16	14	HB
6	<i>Ensifer</i> sp. PCH186	96	1.57	0.77	49.1	HB
7	<i>Janthinobacterium</i> sp. PCH172	72	1.9	0.8	40	HB
8	<i>Janthinobacterium</i> sp. PCH175	96	1.28	0.69	53	HB
9	<i>Bacillus</i> sp. PCH190	72	2.28	0.1	5	HB, HO
10	<i>Paenarthrobacter</i> sp. PCH191	24	1.54	0.41	26.6	HB
11	<i>Microbacterium</i> sp. PCH192	24	1.19	0.8	67.2	HB
12	<i>Janthinobacterium</i> sp. PCH165	168	2.3	0.05	2.1	HB

HB = Hydroxybutyric acid, HO = Hydroxyoctanoic acid, HTD = Hydroxytetradecanoic acid.

### Bioprospection of potential enzymes from bacteria of alpine regions of eastern Himalaya

The environmental samples from east Rathong glacier of Sikkim Himalaya were processed to obtain 170 unique morphotypes of bacteria. Out of these, 74 representative strains were characterized and the whole genomic DNA data repository of psychotropic bacteria submitted to NCBI which included *Arthrobacter* sp. ERGS1:01 (Accession nos. CP012477-CP012479), *Chryseobacterium polytrichastri* ERMR1:04 (Accession no. LIRF00000000), *Microterricolaviridarii* ERGS5:02 (CP014145), *Arthrobacter alpinus* ERGS4:06 (CP013200, CP013201), *Janthinobacterium lividum* ERGS5:01 (MAQB02000000) and *Pseudomonas frederiksbergensis* ERGS4:02 (CP017886, CP017887). In a study on the genetic basis of psychrotroph survival in a glacial lake, a bacterial strain ERGS5:01 of *Janthinobacterium lividum* was identified (Fig. 3). The strain was unique and produced light pink instead of violet colonies.

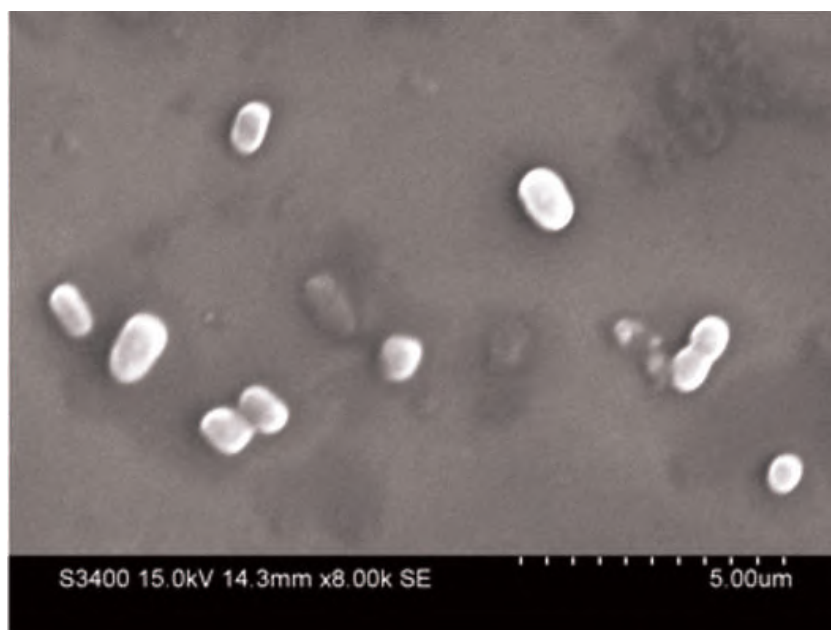

**Fig. 3** Scanning electron micrograph of *J. lividum* strain ERGS5:01 after 48 h of growth on ABM agar plates at 10° C. Bar, 5 µm

The PacBio RSII sequencing was performed to generate a genome of 5,168,928 bp with 4575 protein-coding and 118 RNA genes. The taxonomy was re-evaluated using multilocus sequence analysis (MLSA) clustering based phylogenetic tree of six concatenated housekeeping genes (Fig. 4). *In silico* DNA-DNA hybridization (DDH) value of 95.1% and average nucleotide identity (ANI) value of 99.25% established the identity of the strain ERGS5:01 (MCC 2953) as a non-violacein producing *J. lividum* (Table 3). Genome comparisons across the genus *Janthinobacterium* revealed an open pan-genome thereby, offering the scope for addition of new orthologous clusters and completing the genomic inventory. The study provided insight into the genetic basis of freezing and frequent freeze-thaw cycle tolerance.

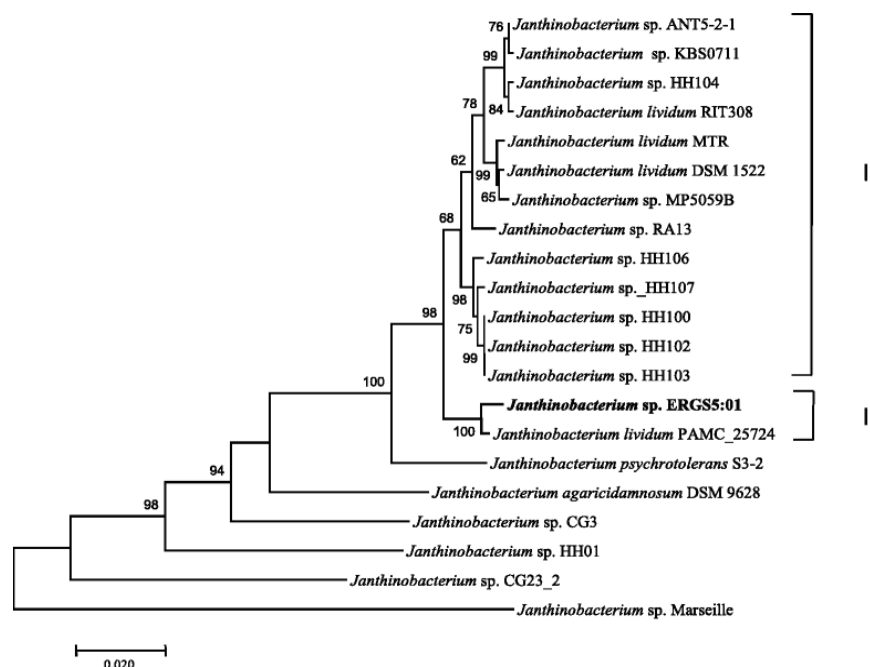

Fig. 4 Multilocus sequence analysis (MLSA) clustering based phylogenetic tree of six concatenated housekeeping genes as derived from the whole genome sequence of identified strains of *Janthinobacterium*. The tree was constructed using the maximum likelihood method based on JTT matrix-based model using MEGA7. Bootstrap values over 50% (1000 replications) are shown at each node. All positions containing gaps and missing data were eliminated. Among *J. lividum*, two clusters were formed; cluster I showing the presence of vioacelin-containing genes but lacking in cluster II

Table 3 Sequence similarity of *J. lividum* ERGS5:01 with described species of genus *Janthinobacterium*; 16S rRNA gene sequence similarity and whole genome sequences based *in silico* comparison of DNA-DNA hybridization (DDH) and average nucleotide identity (ANI)

Strain Name	16S rRNA gene similarity <sup>a</sup>	DDH (Model-based Confidence Interval) (%)	ANI (%)
<i>Janthinobacterium lividum</i> PAMC25724	99%	95.10 (93.5 - 96.3)	99.25
<i>Janthinobacterium lividum</i> DSM 1522	99%	38.30 (35.9 - 40.9)	89.53
<i>Janthinobacterium psychrotolerans</i> S3-2	99%	26.80 (24.4 - 29.3)	82.13
<i>Janthinobacterium agaricidamnorum</i> DSM 9628	99%	23.00 (20.7 - 25.5)	78.86

<sup>a</sup> Values for 16S rRNA identity based on NCBI BLAST alignment of the ERGS5:01 16S rRNA gene against genomes in IMG

Another psychrotrophic bacteria, *Pseudomonas frederiksbergensis* ERDD5:01 was isolated from the glacial stream at east Rathong (4718 m asl). The bacteria was resistant to freezing, frequent freeze-thaw cycles, and UV-C radiations (Fig 5). The complete genome of the circular chromosome (5,746,824 bp) and a plasmid of 371,027 bp were sequenced. When the genome was compared with that of 15 mesophilic *Pseudomonas* species, the presence of industrially important enzymes was revealed.

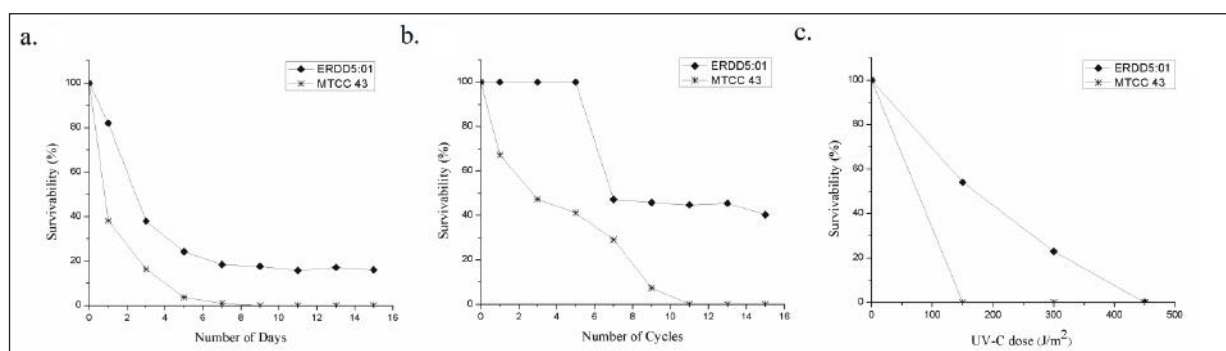

**Fig. 5** Survival of *P. frederiksborgensis* strain ERDD5:01 to (a) freezing (b) freeze-thaw cycle and (c) UV-C irradiation using colony count method. The count of unfrozen and non-irradiated sample were considered 100%. Mean of triplicate colony count were used to calculate the survival percentage and strain *E. coli* MTCC43 served as mesophilic counterpart

### Exploration of organic wastes and composts of Lahaul region for the isolation of bacteria with organic waste degradation potential

Microbes from organic wastes and composts of western Himalayan regions of Lahaul were explored in search of efficient decomposers of organic wastes in cold regions. Organic wastes and compost samples were collected from the villages of Lahaul region. Microbial samples were collected from the upper Suman, Phunkiyyar, Ghoshal, Jhunda, Khanjar, Shukto and Urghosh villages. Study revealed alkaline pH values (7.5-10) of soil samples, while the EC values ranged from 300-3500  $\mu\text{S}$  with lowest (333  $\mu\text{S}$ ) and highest (3250  $\mu\text{S}$ ) values. Finally, eight out of 13 compost samples were selected for bacterial analysis. A total of ~400 unique psychrotrophic bacterial strains were isolated for the screening of potential organic waste decomposers. Qualitative screening for hydrolytic enzymes revealed 27% protease, 24% cellulose, 15% lipase, 7% phospholipase and 5% amylase positive strains. These bacteria have the potential for efficient organic waste degradation.

### Computational approaches to minimize the glutaminase activity in L-asparaginase

A docking study was conducted to understand the binding behavior of the enzyme (L-asparaginase) with its substrates i.e., L-asparaginase (L-Asn) and L-glutaminase (L-Gln). The stability of the enzyme and its complexes under diverse physiological conditions were also studied by molecular dynamics and simulations methods. In order to minimize the glutaminase activity, mutation(s) were induced in the L-Gln interaction and disrupting the L-asparaginase but not altering the latter's activity.

### Identification of key genes regulating nitrogen use efficiency in *Brassica juncea* L. through transcriptome and co-expression network analyses

The RNA-seq approach was employed to understand the nitrate regulatory mechanism in Pusa Bold (PB, high-NUE) and Pusa Jai Kisan (PJK, low-NUE) cultivars of *B. juncea*. A total of 4031, 3874 and 3667 genes in PB and 2982, 2481 and 2843 genes in PJK were found to

express differentially in response to early, low (0.25 mM KNO<sub>3</sub>), medium (2 mM KNO<sub>3</sub>) and high (4 mM KNO<sub>3</sub>) nitrate treatments as compared to control (0 mM KNO<sub>3</sub>). Genes of N-uptake (*NRT1.1*, *NRT1.8*, and *NRT2.1*), assimilation (*NR1*, *NR2*, *NiR*, *GSI.3*, and *Fd-GOGAT*) and remobilization (*GDH2*, *ASN2-3* and *ALaT*) were highly-upregulated in PB than in PJK in response to early nitrate treatments. In addition, transcription factors and protein kinases that were rapidly induced in response to nitrate were identified suggesting their involvement in nitrate-mediated signaling. Co-expression network analysis revealed four nitrate specific modules in PB enriched with phenylpropanoid pathway, nitrogenous compounds and carbohydrate metabolism. HUB transcription factors like mTERF, FHA, Orphan, bZip and FAR1 were also identified indicating their role as key regulators of nitrate-mediated response in *B. juncea*.

### Genetic differentiation responsible for phenotypic variation between high and low elevation populations of *Rumex nepalensis*

The seed traits, phenology and photosynthetic characteristics of four different populations of *Rumex nepalensis* growing at different elevations ranging from 800 to 4000 m amsl were studied. Seeds of alpine region were larger in size and germinated at 15°C than at 25°C. All the populations raised from seeds collected from different elevations were grown under ex situ conditions of greenhouse. The alpine population emerged late but completed its post flowering phenophases much earlier reducing its life cycle by 14 days. The photosynthetic traits of the alpine and sub-tropical were also significantly different. This study suggested that *R. nepalensis* growing in alpine zone was more susceptible to global warming and had little scope for upward movement. Despite being photosynthetically efficient, the alpine genotype was more threatened as compared to other populations from lower elevations (Fig. 6).

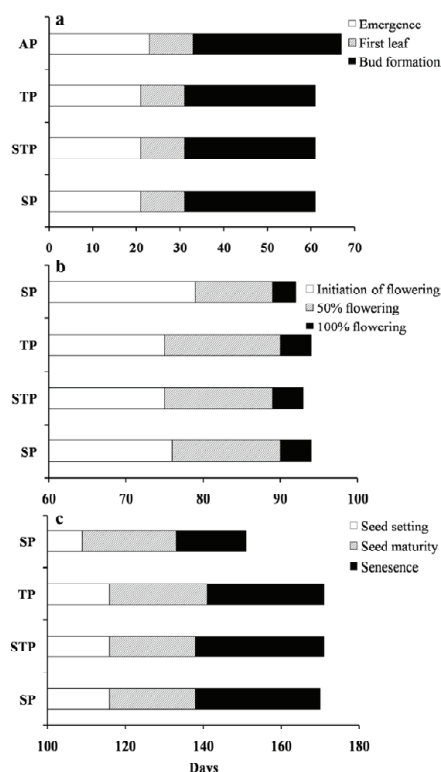

**Fig. 6 (a–c)** Response of *Rumex nepalensis* populations raised from seeds of SP: sub-tropical (800 m amsl); STP: sub-temperate (1300 m amsl); TP: temperate (2200 m amsl); AP: alpine (4000 m amsl) and grown under greenhouse conditions

### Functionally active form of *Camellia sinensis* polyphenol oxidase (CsPPO) successfully expressed in bacterial host

The heterologous expression of *Camellia sinensis* polyphenol oxidase (*CsPPO*) in *Escherichia coli* was optimised. A synthetically constructed codon-optimized *CsPPO* was cloned into pET47 b(+) vector and expressed in a bacterial host. Ectopic expression led to the formation of inclusion bodies. Active PPO from solubilised inclusion bodies and copper content of 0.880±0.095 g atom/g atom of protein was obtained after extensive standardization. Maximum PPO activity was recorded in a rapid dilution buffer containing 0.5 M L-arginine. Refolded

CsPPO had an optimum pH of 5.0 and  $K_m$  values of 3.10, 0.479, and 0.314 mM, and a  $V_{max}$  of 163.9, 82.64, and 142.8 U/mg of protein for catechol, catechin, and epicatechin, respectively. The study provided an opportunity to improve PPO activity at a commercial level without depending on tea leaves (Fig. 7)

### Improved re-assimilation of photorespired $CO_2$ and $NH_3$ through heterologous expression of key candidate genes of C and N metabolism

The molecular, physiological and biochemical adaptation in plants with respect to sequestration of carbon (C) and nitrogen (N) was studied.  $C_3$  plants grown at low (1,300 m) and high (4,200 m) altitudes do not exhibit significant difference in net photosynthetic rate ( $P_N$ ), despite reduced partial pressure of gases, high light intensity and other environmental parameters prevailing at high altitude. There was a shift in photosynthetic mechanism with significant increase in phosphoenolpyruvate carboxylase (PEPCase), aspartate aminotransferase (AspAT), glutamine synthetase (GS), and Rubisco activities at high altitude. This indicated their role in optimized photosynthesis with minimum photorespiratory loss of C and N. Higher activities of these enzymes was also attributed to C and N conservation in plants. In order to investigate any growth advantage in a  $C_3$  species due to higher expression of corresponding genes, transgenic lines of *Arabidopsis thaliana* for heterologous expression of *ZmPEPcase*, *GmAspAT* and *NtGS* were developed. Highest gains in shoot dry weight was recorded in transgenic lines co-expressing all the three genes. In tracer experiments with  $NaH^{14}CO_3$ , the co-expression of *ZmPEPcase*, *GmAspAT* and *NtGS* resulted in a higher flux of assimilated  $CO_2$  toward sugars and amino acids. The transgenic lines showed higher capacity to re-assimilate both  $CO_2$  and  $NH_3$  evolved during the process of photorespiration, as compared to the wild type (Fig. 8). The transgenic lines had significantly higher shoot biomass and seed yield under optimal as well as limiting levels of nitrogen.

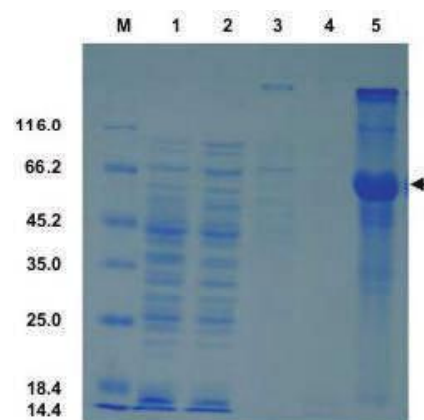

Fig. 7 SDS-PAGE analysis of induced protein in soluble and pellet fractions. Lane M, molecular weight marker (kDa); lane 1, uninduced control; lane 2, soluble fraction after cell lysis; lanes 3, 4, and 5, cell pellet extracted with different buffers such as 2% Triton X-100, 2 M urea and 8 M urea, respectively. Arrow shows the induced CsPPO protein

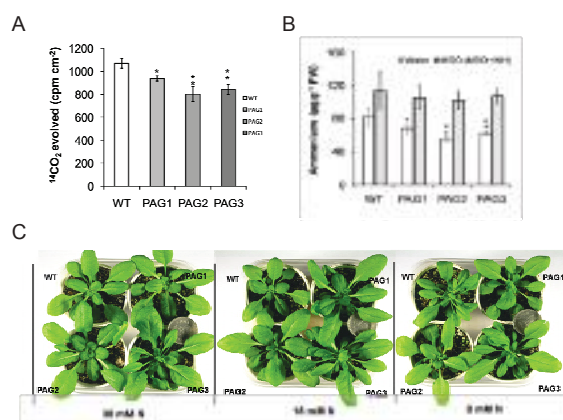

Fig. 8 (A, B) Higher re-assimilation photo-respiratory  $CO_2$  and  $NH_3$  in transgenic lines of *Arabidopsis* coexpressing *ZmPEPcase*, *GmAspAT* and *NtGS*. (C) transgenic lines exhibited improved growth under optimal as well as limiting levels of nitrogen

### Superoxide Dismutase (SOD) tailored for higher thermostability relevant for industrial application

Energy, ensemble and evolutionary based experimental as well as site-directed mutagenesis approaches were employed to improve the biophysico-chemical properties of PaSOD. The enzyme is a thermostable Cu-Zn superoxide dismutase from *Potentilla atrosanguinea* (E.C.1.15.1.1) found to function in a wide range of temperatures (80-100 °C) PaSOD. It has one Zn ion with potential to hold an empty pocket for accommodating Cu ion by replacing water molecules.

### Effect of elevated CO<sub>2</sub> and elevated temperature on *Hypericum perforatum*

*Hypericum perforatum* (family Hypericaceae) known as St John's Wort, is a perennial herbaceous plant used mainly as antidepressant. Effect of elevated CO<sub>2</sub> and elevated temperature on growth, phenology and yield of *H. perforatum* was studied during 2017 under ambient, free air temperature increase (FATI), free air carbon enrichment (FACE), and FACE+FATI facility in the institute. Data revealed that among different environmental conditions, combined effect of elevated CO<sub>2</sub> and temperature (FACE+FATI) recorded significantly higher total dry biomass at 140 and 280 days after exposure (DAE) as compared to ambient, FACE and FATI conditions (Fig. 9).

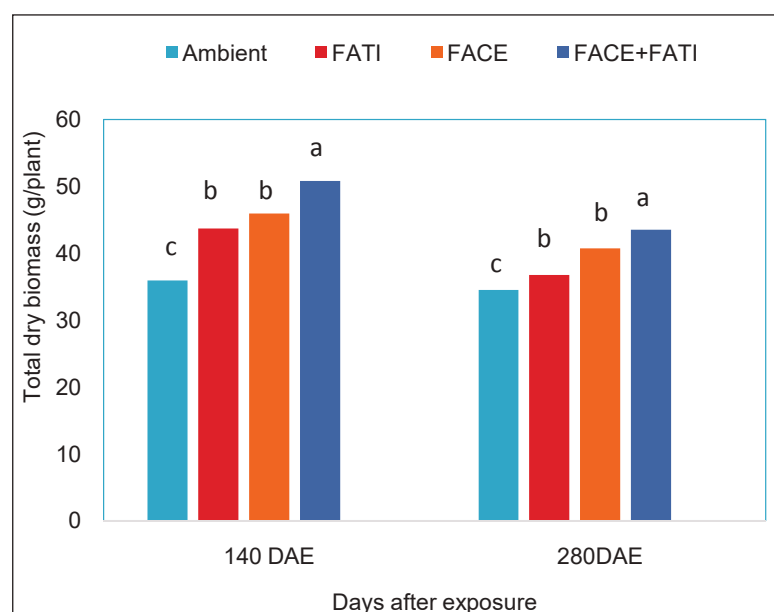

Fig. 9 Effect of environmental conditions on total dry biomass of *H. perforatum* at 140 and 280 days after exposure (DAE)



*Centre for High Altitude Biology (CeHAB)*



Seed repositories of 34 species were developed for important medicinal and aromatic plants of cold desert area nursery gene bank was also developed (Table 1).

**Table 1 Details of important medicinal and aromatic plants established in the nurseries**

Species	Total plants established in the nursery gene banks
<i>Valeriana jatamansi</i>	900
<i>Aconitum heterophyllum</i>	App. 25000 plants
<i>Fagopyrum tataricum</i> (Chinese accession)	App. 600 m <sup>2</sup> area
<i>Ginkgo biloba</i>	340
<i>Salvia sclerea</i>	App. 4000 m <sup>2</sup> area
<i>Hippophae</i> accessions	900 plants
<i>Saussurea costus</i>	App. 20000 plants
<i>Inula racemosa</i>	App. 12000 plants
<i>Carum carvi</i>	150 m <sup>2</sup> area

New floriculture crops like *Gladiolus* sp. *Tagetes erecta*, *Lilium* varieties, *Chrysanthemum* sp. were introduced for commercial purpose in the CeHAB farm and farmers field. *Panax ginseng*, *Aconitum heterophyllum*, *Picrorhiza kurrooa*, *Salvia sclarea*, *Tulip* sp. were maintained in farmers field. Conservation of rare and threatened species in the field gene banks/herbal garden and seed repositories were also maintained at CSIR-CeHAB, Ribling (3450m amsl) (Fig 1).

#### Training programmes organised

- Facilitated trainees on incubation on essential oil extraction unit (200Kgs, 50Kgs, 10Kgs).
- Supported incubation of Sh. Shakti Singh and Sh. Sudarshan, village Gaushal, Lahaul-Spiti on seabuckthorn, tea and buckwheat technology.
- Organized a field visit cum training programme at CeHAB farm Ribling for 22 villagers of Tandi Panchayat on 10 and 13 November 2017.

#### Glimpse of ongoing field trials at CeHAB



*Valeriana jatamansi*



*Saussurea costus*



*Aconitum heterophyllum*



*Picrorhiza kurrooa*



*Inula racemosa*

**Fig. 1** *Ex-situ* conservation of RET plants at CeHAB

Mass cultivation of commercially important medicinal and aromatic plants like (*Aconitum heterophyllum*, *Inula racemosa*, *Valeriana jatamansi*, *Saussurea costus*, *Picrorhiza kurrooa* and *Panax ginseng* was achieved (Fig. 2 & 3).



Fig. 2 Cultivation of medicinal plants in green houses



Fig. 3 Mass cultivation of medicinal plants under shade nets

**Project: Introduction, adaptation and value addition of important medicinal and aromatic plants in trans Himalayan region**

Under this project four trainings on production and process technologies of medicinal and aromatic plants species were imparted to the tribal farmers during May 2017 to January 2018. Training on nursery raising, cultivation and essential oil extraction of aromatic plants were imparted to the tribal farmers. Practical exposure on field preparation for nursery beds, plantation of crops, harvesting of crops at proper stage to obtain higher essential oil content and composition, essential oil extraction in cleverger apparatus, mini distillation unit and pilot plant were imparted (Table 2 & Fig. 4).

**Training programme**

**Table 2 Training conducted at CeHAB for popularization of MAPS**

Details of training	Coordinator	Date	Venue	Participant Villages	No. of Participant
Production technology and Multiplication techniques of important medicinal and aromatic plants	Dr Rakesh Kumar	28.05.2017	CeHAB, Ribling (Tandi), Keylong, district Lahaul & Spiti.	Goshal	15

Details of training	Coordinator	Date	Venue	Participant Villages	No. of Participant
Training cum awareness program on Cultivation technology of important aromatic plants	Dr Rakesh Kumar	22.07.2017	Jagla district Lahaul & Spiti.	Kiyor, Jagla, Gondhla	7
Production technology and Multiplication techniques of important medicinal and aromatic plants	Dr Rakesh Kumar	31.08.2017	CeHab lab Tandi, district Lahaul & Spiti.	Tandi, Malang	16
Production technology and Multiplication techniques of important medicinal and aromatic plants.	Dr Rakesh Kumar	27.10.2017	CeHAB, Tandi, Keylong, district Lahaul & Spiti.	Malang	33



Fig. 4 Imparting trainings to the tribal farmers on agro and process technologies of aromatic plants

# Chemical Technology





## Natural Product Chemistry

The medicinal value of Himalayan plants is well established in traditional systems of medicine. However, their commercial acceptability is not as per expectation due to lack of scientific validation. Therefore, efforts were made to validate these properties through phytochemical investigations.

### Quantitative and qualitative analysis of *Eruca sativa* and *Brassica juncea* seeds by UPLC-DAD and UPLC-ESI-QTOF

*E. sativa* and *B. juncea* belong to the Brassicaceae family and have been traditionally used for the treatment of cancer and various cardiovascular ailments. A rapid and simple ultra-performance liquid chromatography (UPLC) method was developed for the simultaneous quantification of erucin, allyl isothiocyanate and benzyl isothiocyanate in *E. sativa* and *B. juncea* oils (Fig. 1). *E. sativa* oil contains erucin (28.93%), benzyl isothiocyanate (0.70%) and allyl isothiocyanate (0.06%). Identification of other secondary metabolites in *E. sativa* and *B. juncea* oil and aqueous methanolic extracts were also carried

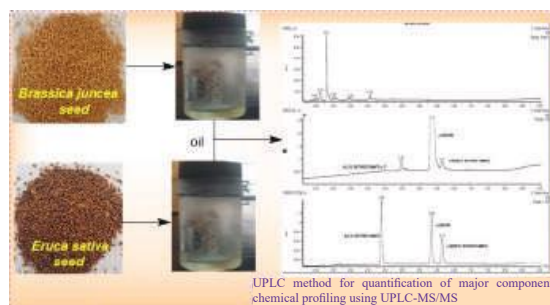
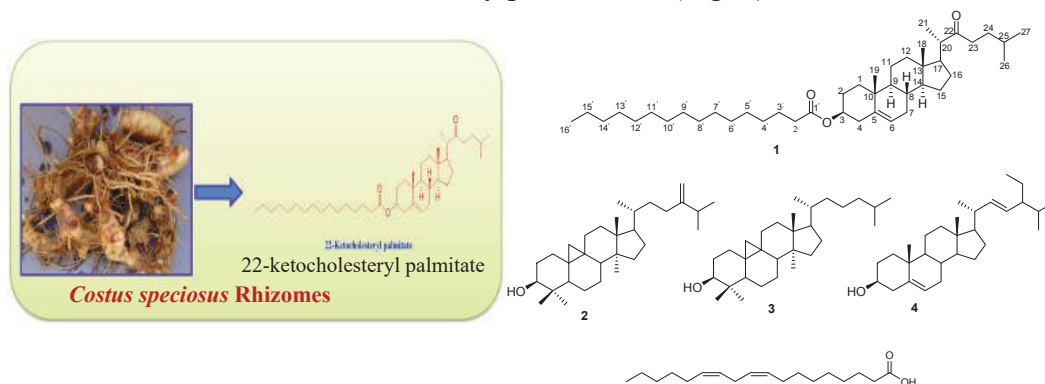

**Fig. 1** Chemical profiling using UPLC-MS-MS for quantification of major components *Eruca sativa* and *Brassica juncea* seeds

out using ultra performance liquid chromatography-electro spray ionization-quadrupole time of flight (UPLC-ESI-QTOF). Ten compounds in *B. juncea* oil and three compounds in *E. sativa* oil were identified by UPLC-ESI-QTOF. Analysis of aqueous methanolic extracts of *E. sativa* and *B. juncea* led to the identification of eight and nine compounds, respectively.

### *Costus speciosus*

Chemical investigation of the rhizomes of *Costus speciosus* led to the isolation of a new compound, 22-ketocholesteryl palmitate (**1**) along with four known compounds, 24-methylenecycloartanol (**2**), cycloartanol (**3**), stigmasterol (**4**) and linoleic acid (**5**). The structure of the new compound was characterized by extensive 1D-, 2D-NMR and mass spectrometry (GC-MS and HR-ESI-MS) techniques. The isolation of 22-ketocholesteryl palmitate (**1**) from *C. speciosus* is the first report of a 22-oxo-sterol derivative from any plant source (Fig. 2).



**Fig. 2** Compounds isolated from rhizomes of *Costus speciosus*

***Roylea cinerea* (D. Don) Baill. (Fam. Lamiaceae)**

*R. cinerea* commonly known as Ashy Royleais and locally as katu is widespread in the Himalayas from Kashmir to Nepal. It is known for its antidiabetic activity. The crude ethanolic and its sub-extracts obtained from the aerial parts were evaluated for antioxidant and antidiabetic activities. The antioxidant activity was evaluated by DPPH, ABTS, FRAP and ORAC assay. The total phenolic content in *R. cinerea* extracts varied widely (Table 1). Reduction in the blood glucose level was observed in albino male wistar rats after 15 days of treatment with ethyl acetate extract *R. cinerea*. Serum lipid profile, hepatic glycogen content, SOD, GPX, GSH and TBARS of pancreatic tissue were also examined. The plant extract increased the level of SOD, GSH and GPX in the tissues and reduced the level of TBARS as compared to control. The finding validated the potent antidiabetic and antioxidant properties of *R. cinerea*.

**Table 1 phenolic content of different extracts of *R. cinerea***

Different extracts	Phenolic content (mg GAEs <sup>a</sup> /g)
Ethyl acetate subextract	65.53±3.25
Chloroform subextract	33.8±2.71
Butanol subextract	95.8±2.72
Ethanolic subextract	45.03±3.00
Water extract	3.87±0.45

***Lepidagathis cuspidata***

Cuspidata a new anti-fungal triterpenoid saponin from *L. cuspidata*, and 3-*O*-methyl epicatechin, quercetin-3-*O*- $\beta$ -D-glucuronide and  $\beta$ -sitosterol-3-*O*- $\beta$ -D-glucoside from *R. nepalensis* were isolated for the first time.

***Rumex* spp.**

*Rumex* is traditionally used to cure pain, inflammation, ulcer, tumor and constipation. The biological potential of *R. nepalensis* lies in the chemical diversity of its constituents. In the present study, UPLC-DAD-MS method was developed for the concurrent estimation of polyphenols in *R. nepalensis*, *R. hastatus* and *R. dentatus* and validated for linearity ( $r^2 > 0.999$ ), LOD & LOQ, stabilities and recovery. The developed method was also employed for metabolomic analysis of *Rumex* species. Highest content of polyphenols was recorded in aerial parts of *R. nepalensis*. The matrix and HCA plot clearly described the variation of metabolites among the samples.

Seven molecules were isolated and characterized. Among these, three compounds viz. 3-*O*-methyl epicatechin, quercetin-3-*O*- $\beta$ -D-glucuronide and  $\beta$ -sitosterol-3-*O*- $\beta$ -D-glucoside were isolated for the first time from this plant. Eighteen metabolites were profiled in *R. nepalensis* using UPLC-MS/MS technique.

***Hedychium spicatum***

*H. spicatum* (Family: Zingiberaceae) is an aromatic crop of higher altitude and endangered due to their high demand in pharmaceutical industries and unplanned, untimely harvesting by local people. A seed germination trial was laid out using selected growth hormones (IAA, IBA and NAA)

at 100, 200 and 500 mg/l during various months. The rhizomes of plants raised from seeds were analyzed for their essential oil content and chemical composition by gas chromatography, GC-FID. Thirty-six components were identified, representing 89.1-95.9% of the total oil (Table 2).

**Table 2 Phenolic profile in *H. Spicatum***

Sr. No.	Phenolic content (mg GAEs <sup>a</sup> /g)	Rhizomes (%)	Roots (%)
1.	$\beta$ -Pinene	2.8	3.7
2.	1,8-Cineole	73.3	42.8
3.	$\gamma$ -Eudesmol	0.2	4.3
4.	Eudesmol (7-epialpha)	5.4	-
5.	Bulnesol	-	9.5

### *Dracocephalum heterophyllum*

In the current year, around 100 ml essential oil was extracted from *D. heterophyllum* onsite at Kaza, (4500 meter asl). The quality of collected sample was analyzed and found that  $\beta$ -citronellol content was around 70-75%. *D. heterophyllum* cultivated at lower altitude at Palampur was also analyzed for its flowers (1.2 kg), essential oil (1.9 ml) and leaves (2.1 kg) for their quality. The obtained essential oils were examined with the help of GC and GC-MS and found that  $\beta$ -citronellol was the major constituent in leaves (~65%) and flowers (~80%). The essential oil quality of the crop was at par with crop grown at higher altitude (~4500 m) and crop grown in wild (Fig. 3A-B).

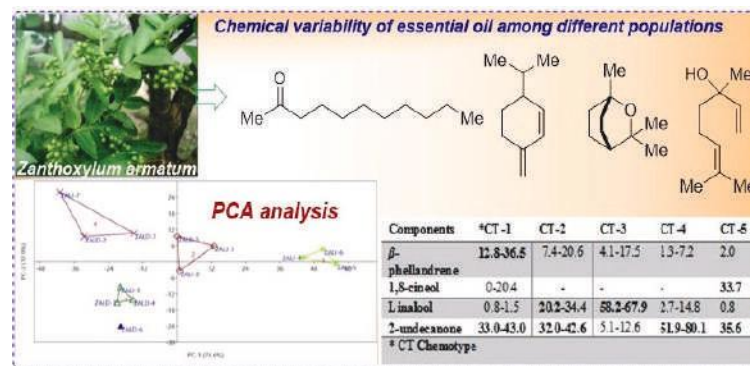

**Fig. 3 *Dracocephalum heterophyllum* (A) crop cultivated at CSIR-IHBT farm (B) crop growing at higher altitude near Kaza**

### *Zanthoxylum armatum*

Essential oil from fresh leaves of seven populations of *Z. armatum*, collected from different locations/ altitudes of H.P. was obtained by the hydrodistillation method. The main constituents of the essential oil, along with the effect of locational and seasonal change in composition was determined by GC-FID and GC-MS. Thirty-five constituents, making up to about 93.1-99.4% of the total composition of oil, were characterized. Among all the characterized components, non-terpenic hydrocarbons (2-undecanone and (*E*)-2-decanal), oxygenated monoterpenes (linalool,

1,8-cineol and  $\alpha$ -terpineol) and monoterpene hydrocarbons ( $\beta$ -phellandrene,  $\alpha$ -pinene, sabinene and  $\beta$ -myrcene) contributed to major proportion of the oil. Principal component analysis was carried out to distinguish the variation in essential oil composition of summer and winter samples. Based on the cluster separation, five chemotypes were identified, representing  $\beta$ -phellandrene/2-undecanone, linalool/2-undecanone, linalool, 2-undecanone, and 2-undecanone /1,8-cineol.



### Characterization of secondary metabolites from *Juglans regia* by spectroscopic techniques

Dyes derived from plants and other sources have versatile applications. These dyes are not only beneficial for health but also to the environment. Plant derived nontoxic, non-allergic, safe and biodegradable dyes are used for colouring packages and various biological properties. In *J. regia*, 5-hydroxy-1,4-naphthaquinone is used in textiles and cosmetics to provide brown shades. The phytochemical investigation of green husk resulted in the isolation of three compounds. Characterization of these compounds was carried out mainly by  $^1\text{H}$  &  $^{13}\text{C}$ , DEPT, HMQC, HMBC and mass spectroscopic studies and structures of compounds were established as 4,8-Dihydroxytetralone (1),  $\beta$ -sitosterol (2), and 5-Hydroxy-1,4-naphthaquinone (3).

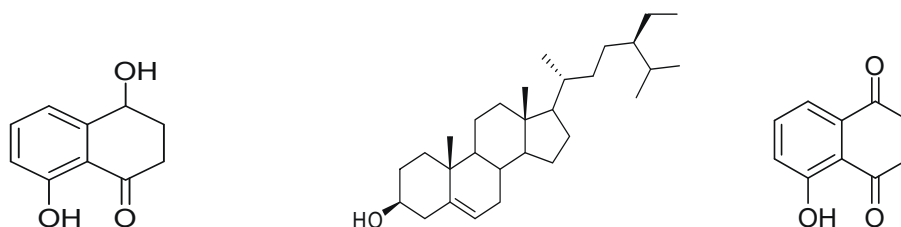

4,8- Dihydroxytetralone (1)     $\beta$ -Sitosterol (2)    5-Hydroxy-1,4-naphthaquinone (3)

### Natural colours/dyes

With increasing awareness for eco-friendly materials from sustainable resources, natural colours/dyes attracted researchers towards traditional and diversified applications and development of cost-effective, eco-friendly and cleaner technologies. These strategies for economic value added products will not only provide high quality products but will also protect from toxic, hazardous and carcinogenic synthetic colours/dyes. Thus extraction protocols for anthocyanins from different plant sources was standardized to obtain natural colours. The extraction of different plants containing anthocyanin resulted in hygroscopic extract (4.4% yield). To enhance

the quality of colour, a simple, green process was developed to remove undesired components (non-colouring materials, organic acids etc) by passing the extract on different adsorbents to obtain water soluble, non-hygroscopic and crystalline solid purple and red colours. The obtained colours were tested for their stability and found to be stable at 120 °C and room temperature for 2 days and 30 days respectively (Fig. 4). To enhance the stability and shelf-life; copigmentation was carried out with above mentioned extracts and it revealed that after copigmentation the colours were stable upto 160 °C and room temperature for 30 days. Both the colours were stable under low temperature < 8°C.

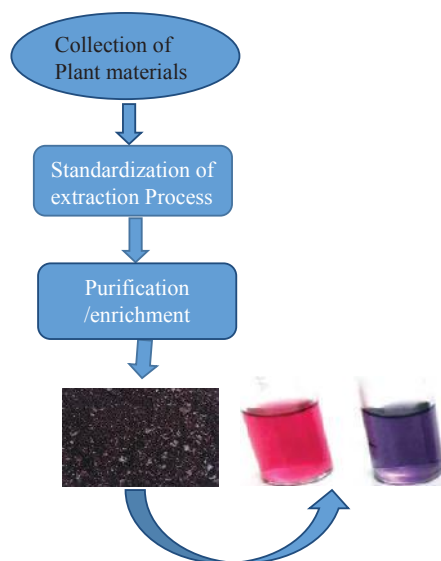

Fig. 4. Extraction of natural colours from plant sources

### *Curcuma longa* and *Rheum emodi*

The dried rhizomes of *C. longa* and *Rheum emodi* were studied for development of colour. The rhizomes of *C. longa* were extracted with methanol and chromatographed over column chromatography. The elution of column with ethylacetate/hexane resulted in pure curcuminoids (stable yellow colour in methanol) in 1.03% yield. Similarly, *Rheum emodi* resulted in pure ethanol soluble anthraquinones responsible for yellow colour in 0.2% yield (Fig. 5 A&B).

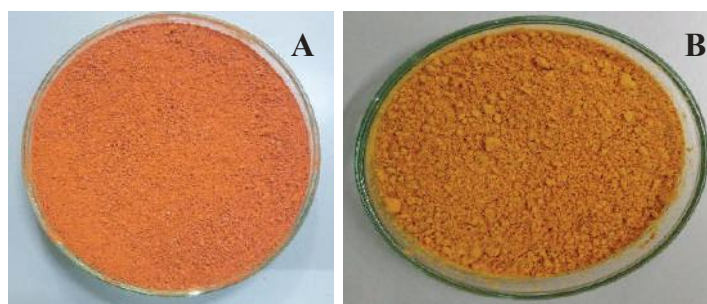

Fig. 5. (A) Rhizome powder, *Curcuma longa* (B) *Rheum emodi*

### Development of green and eco-friendly processes from natural resources based on traditional knowledge in the area of cosmetics (hair dye)

The different compositions of hydroalcoholic (EtOH: H<sub>2</sub>O) and aqueous extracts of plants, with or without mordants were used to study the colour effects on human hairs. The human white hairs were used as control, (Fig. 6A). The mordants used for the study were ferrous sulphate, iron and lohbbhashama. The colours obtained from the formulations varied from reddish brown, light brown to black brown (Fig. 6B, C, D). The different compositions of plant extracts of *L. inermis*, *I. tinctoria*, *E. officinalis*, *J. regia*, *T. chebula*, *E. alba*, *B. monnieri*, *M. koengii*, *A. aspera* (ash), *A. catechu* and *V. jatamansi* were applied for 2-3 hours, washed and extract of *I. tinctoria* was applied for another 30 minutes and washed with water. After washing, the hairs appeared purple blue but turned into blackish brown colour after 2-3 hours.

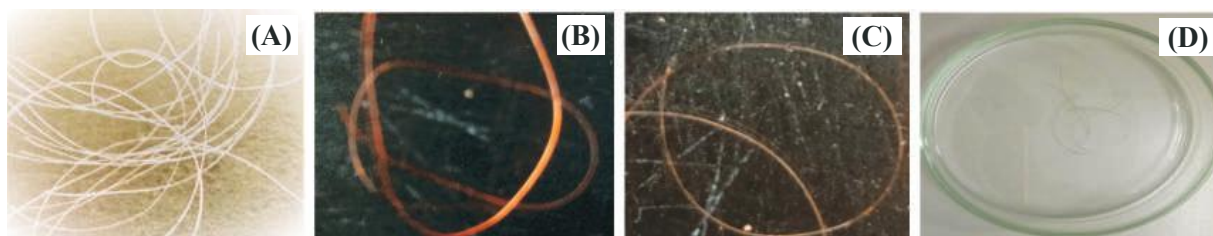
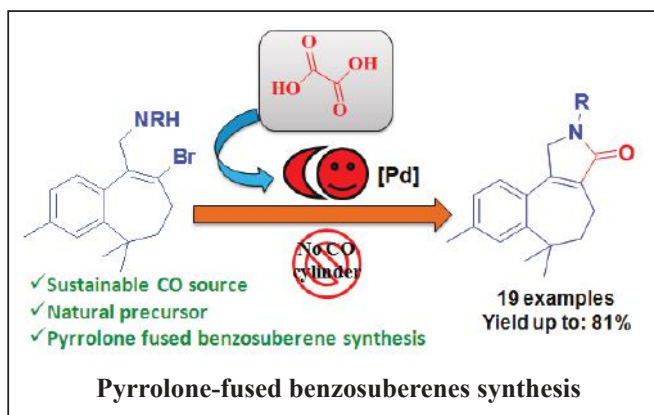

Fig. 6 (A) Human white hair as control, (B) reddish Brown colour, (C) light brown (D) blackish brown after dyeing with different plants

## SYNTHETIC ORGANIC CHEMISTRY

### Oxalic acid as sustainable CO source for pyrrolone-fused benzosuberenes synthesis through palladium catalyzed carbonylative cyclization reaction

Oxalic acid was used as safe, environmentally benign and operationally simple in situ CO source for the palladium catalyzed conversion of amino-vinyl-bromide substituted benzocycloheptene analogues and production of corresponding pyrrolone-fused benzosuberenes. This is a selective intra-molecular carbonylative cyclization strategy for pyrrolone-fused tricyclic conjugate system of himachalene, an essential oil component of *Cedrus deodara* sp.



### Oxalic/malonic acids as carbon building blocks for benzazole, quinazoline and quinazolinone synthesis

An oxidant, base and metal free methodology was developed for the synthesis of various 2-substituted and non-substituted benzazoles, quinazolines and quinazolinones using oxalic/malonic acids as an in situ carbon source. This methodology is applicable to a wide range of substituted *o*-phenylenediamine, *o*-aminothiophenol, *o*-aminophenol and *o*-aminobenzamide containing various functional groups. It also provides good to excellent yields of the corresponding product.

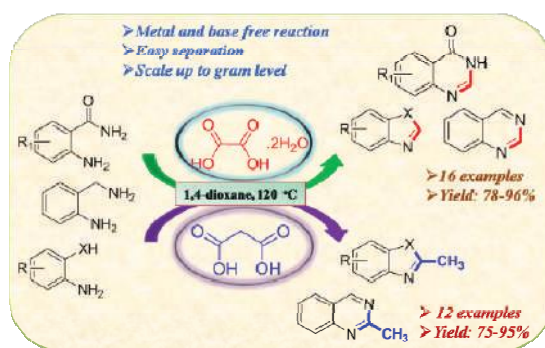

Synthesis of heterocycles

### Process development for 5-hydroxymethylfurfural (5-HMF) synthesis from carbohydrates

An efficient and high yielding process for the synthesis of 5-hydroxymethylfurfural (5-HMF) from rice straw derived cellulose, waste potato, sugarcane bagasse, cellulose, starch, different sources of carbohydrates was developed to enhance the scope of further application to glucose and fructose. The reagents and conditions played a significant role in selective hydrolysis, dehydration and cyclization reaction to give 5-HMF in a highly selective manner without the need for tedious and costly purification methods.

### Microwave assisted metal-/oxidant-free cascade electrophilic sulfenylation/5-endo-dig cyclization of 2-alkynylanilines to generate diversified 3-sulfonylindoles

A metal-/oxidant-free sustainable protocol for the synthesis of 3-sulfonylindoles based on electrophilic cyclization of 2-alkynylanilines was developed under microwave irradiation. The catalytic amount of iodine and stoichiometric amount of sulfonyl hydrazides were employed as catalyst and electrophiles, respectively to induce the 5-endo-dig cyclization of 2-alkynylanilines. The strategy allows a wide substrate scope, demonstrates good functional group tolerance, utilizes easily available reagents and overcomes multistep synthesis.

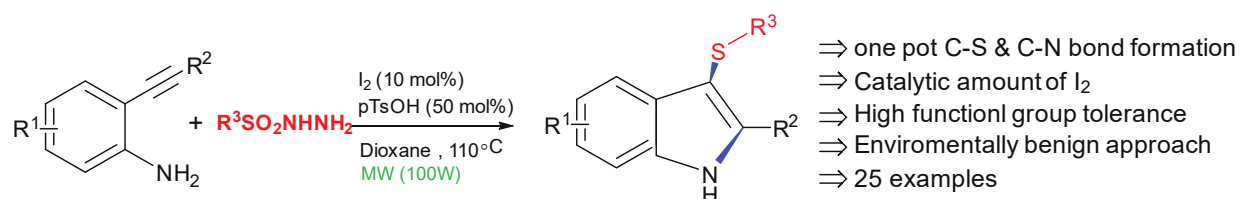

### Synthesis of diverse nitrogen heterocycles *via* palladium-catalyzed tandem azide–isocyanide cross-coupling/cyclization

A rapid and elegant tandem azide–isocyanide cross-coupling/cyclization protocol was developed based on a nitrene transfer reaction. The Pd-catalyzed ligand-free methodology led to the synthesis of three different heterocyclic scaffolds with excellent atom/step/redox economy. Studies based on first-principles-based quantum calculations and control experiments unraveled a concerted process of nitrene transfer reaction on isocyanides, ruling out the metallazaaziridine intermediate reported earlier.

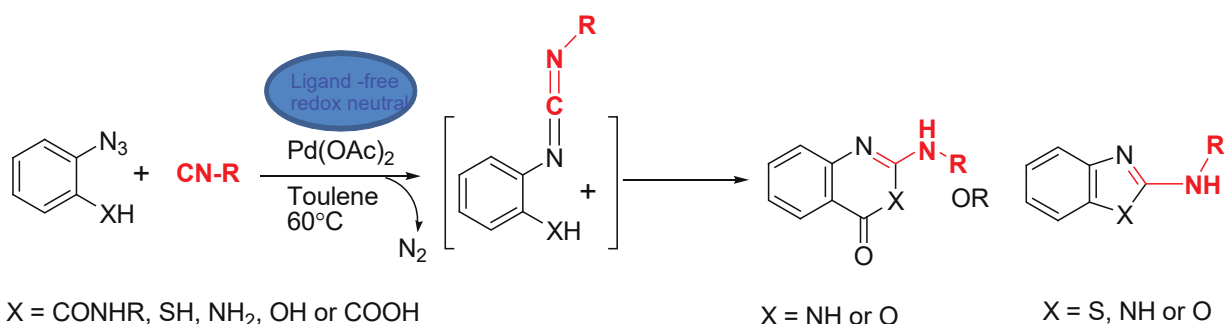

### New eco-friendly method for C-N bond formation using organocatalysis

2-Aminoquinazolin-4(3*H*)-one was used as an organocatalyst for the activation of aldehydes via non-covalent interaction and synthesis of tertiary amines using formic acid as a reducing agent. The developed protocol demonstrated a broad substrate scope for aromatic and aliphatic amines utilizing varieties of aromatic and aliphatic aldehydes. The developed method was successfully utilized for the derivatization of ciprofloxacin and its derivative for good to excellent yields.

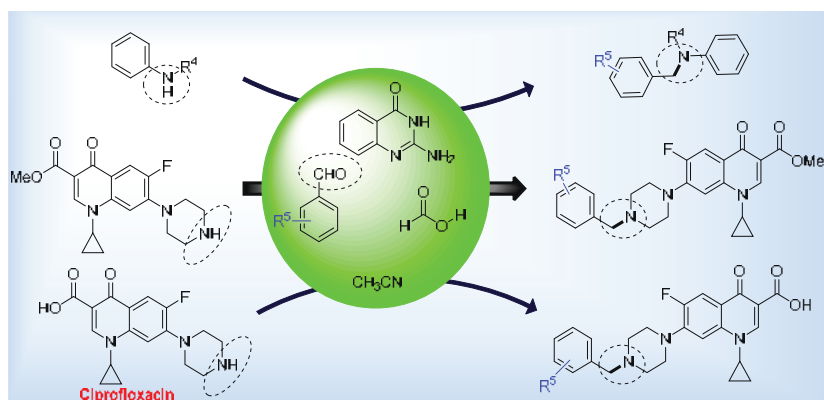

### Chemoselective reduction of nitroarenes using 2-aminoquinazolin-4(3*H*)-one as an organocatalyst

A guanine-type bicyclic moiety, i.e. 2-aminoquinazolin-4(3*H*)-one was reported for the first time as a hydrogen bond donor/accepter organocatalyst facilitating the reduction of nitroarenes. The



novel, mild and transition metal free, 2-aminoquinazolin-4(3*H*)-one assisted reduction of nitroarenes employing hydrazine hydrate as reducing agent and potassium carbonate as a base. Activation of hydrazine hydrate with organocatalyst was explored for the reduction reactions for the first time. The current protocol avoids the use of hazardous reagents, high pressure, flammable hydrogen gas and harsh reaction conditions.

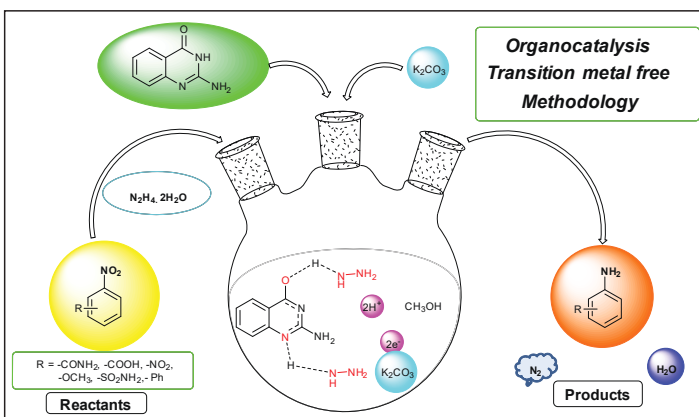

### Ligand-free iron(II)-catalyzed N-alkylation of hindered secondary arylamines with non-activated secondary and primary alcohols via a carbocationic pathway

Secondary benzylic alcohols represent a challenging set of substrates for N-alkylation of amines. Therefore, a novel strategy for the N-alkylation of arylamines with readily available alcohols via a carbocationic pathway was conceptualized. This iron(II)-catalyzed eco-friendly protocol follows a carbocationic pathway instead of the known borrowing hydrogen transfer (BHT) approach. The scope of this methodology involves N-alkylation of primary, secondary and heterocyclic amines with primary/secondary benzylic, allylic and heterocyclic alcohols, which are common key structures in numerous pharmaceuticals drugs and also in amination of various natural products.



### Sustainable and efficient CuI-NPs-catalyzed cross-coupling approach for the synthesis of tertiary 3-aminopropenoates, triazoles, and ciprofloxacin

The distinctive properties of metal nanoparticles have attracted significant attention from synthetic chemists, particularly for application in heterogeneous catalysis. A novel protocol for the synthesis of 3-aminopropenoates with broad substrate scope using CuI NPs was developed. The current methodology exhibited its utility in the synthesis of 1,4-disubstituted 1,2,3-triazoles with wide substrate scope. The method was also utilized for the synthesis of antibacterial drug ciprofloxacin and its derivatives in gram scale.

### Peripheral C-H activation/functionalization of quinolines with unactivated olefins: DMF as hydrogen source and total synthesis of EP4 agonist

A rhodium-catalyzed unprecedented distal C(sp<sup>2</sup>)-H bond alkylation of quinoline

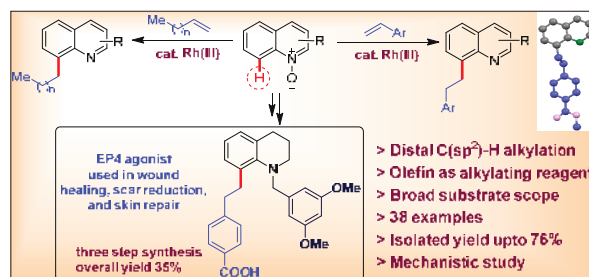

*N*-oxides using olefins as alkyl source and *N*-oxide as the traceless directing group was developed. The reaction exhibited broad substrate scope with excellent selectivity for C-8 position and there was good yields of alkylated products. The usefulness of the developed catalytic protocol was established by synthesis of EP4 agonist. In mechanistic study C-8 olefinated quinoline was identified as the reaction intermediate, which gets reduced to desired C-8 alkylated product in the presence of Rh(I) species (produced from Rh(III) during the course of reaction) and formic acid. Formic acid is produced from DMF in the presence of  $\text{AgBF}_4$ .

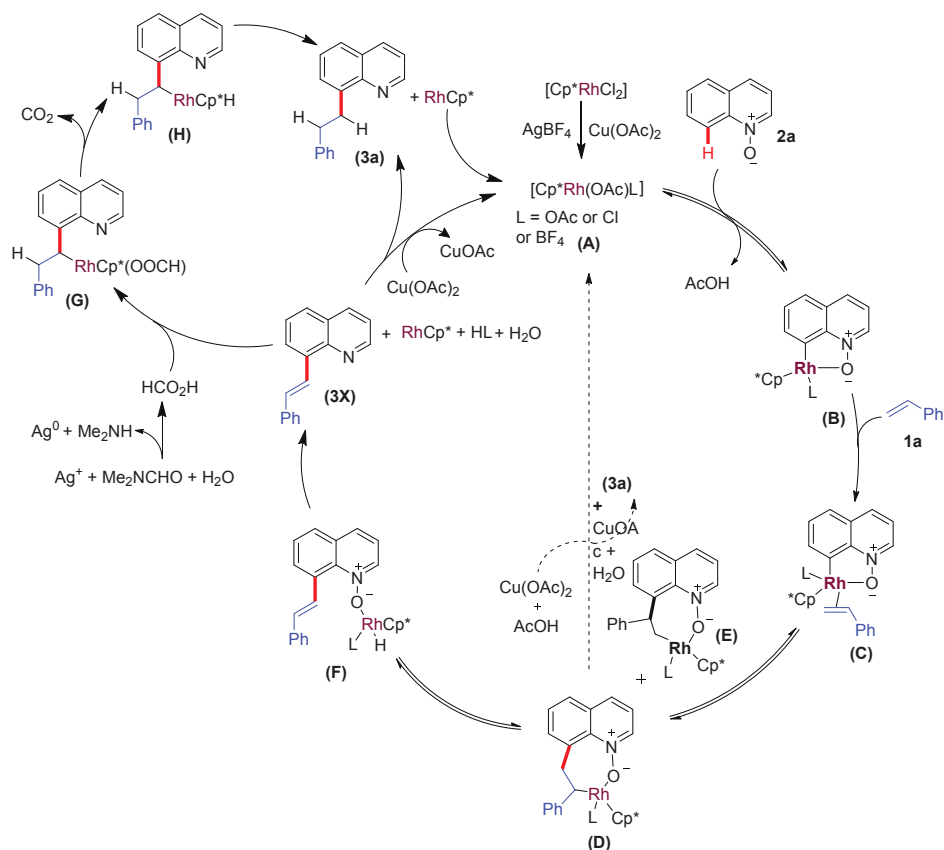

### Employing benzyne chemistry for the synthesis of quinoline and acridine derivatives

A metal-free approach for the synthesis of 3-aryl-2-substituted quinolines and 4-arylacridines was

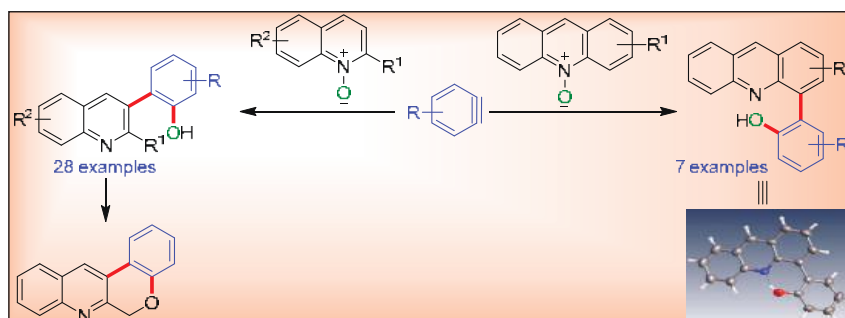

developed *via* the 1,3-dipolar cyclo addition reactions of arynes with *N*-oxides. Reactions of various 2-substitued quinoline *N*-oxides with *ortho*-(trimethylsilyl) aryltriflates in the presence of KF gave 3-(2-hydroxyaryl) quinoline derivatives in good yields. Acridine *N*-oxides also reacted with arynes to furnish 4-(2-hydroxyaryl)acridines, albeit in moderate yields.

### Development of process for converting raw cellulosic biomass into textile fiber and nanocellulose

The increasing cost and decreasing availability of petroleum resources and limitations in the availability of land, water, and other resources required to grow natural fibers either restrict the availability and/or increase the price of common fibers making them unaffordable for commodity applications. Finding alternative sources for the natural fibers in current use is essential to have adequate supply of fibers at affordable prices in future. Attempts were made to explore best and economically viable sources for the isolation of cellulose. In addition, pure cellulose was converted into textile fiber and nanocellulose (NCs).

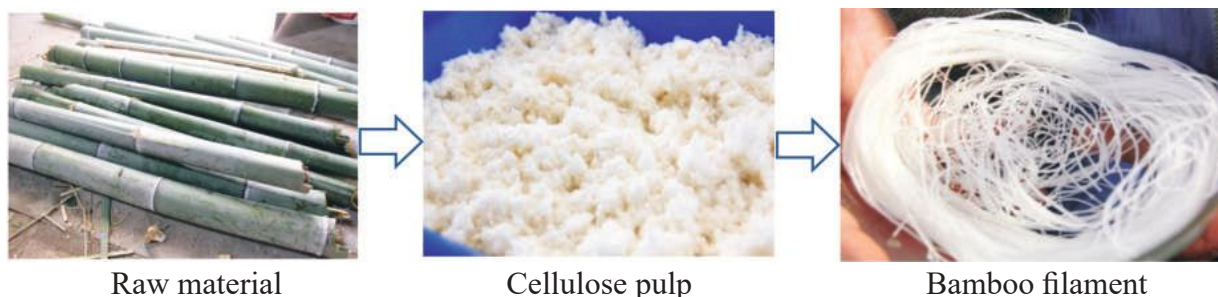

## ESSENTIAL OILS

### Antibacterial activities of essential oils from cultivated clones of *Juniperus communis* and wild *Juniperus* species

The antibacterial activity of the essential oils (EOs) from three wild *Juniper* species of high altitudes (JC, JI, JR) and seven cultivated clones from lower altitudes (C1-C7) were evaluated using six bacterial strains (Table 2). The EOs of C6 inhibited the growth of five out of six bacteria tested. Clone, C7 exhibited the highest zone of inhibition against *Staphylococcus aureus* MTCC 96. Both wild and cultivated species exhibited antibacterial activities against *S. aureus* MTCC 96 and *Micrococcus luteus* MTCC 2470 but the growth of *Klebsiella pneumoniae* MTCC 109 was not inhibited. The study concluded that the EOs from studied plant species have potential antibacterial activity against important pathogenic strains and can be exploited for their utility as natural antimicrobial agents (Table 3).

**Table 3 Antibacterial activity of EOs of cultivated and wild species of *J. communis* estimated by the diameter of inhibition zones. Data are presented as mean  $\pm$  SD**

Bacterial strains	Diameter of inhibition zone (mm) imposed by 10 $\mu$ L EOs/well											
	C1	C2	C3	C4	C5	C6	C7	JC	JI	JR	Ampicillin (10 $\mu$ g/disc)	
<b>Gram-positive</b>												
<i>Bacillus subtilis</i> MTCC 121	11.8 $\pm$ 0.3	11.2 $\pm$ 0.3	10.7 $\pm$ 0.3	11 $\pm$ 1.0	11.8 $\pm$ 0.3	11.5 $\pm$ 0.5	9.7 $\pm$ 0.6	11.7 $\pm$ 0.6	10.8 $\pm$ 0.8	11.5 $\pm$ 0.9	18.8 $\pm$ 0.3	
<i>Staphylococcus aureus</i> MTCC 96	18.8 $\pm$ 1.0	14.5 $\pm$ 0.5	15 $\pm$ 0.5	15 $\pm$ 1.0	12.5 $\pm$ 0.5	16.8 $\pm$ 0.3	19.2 $\pm$ 0.7	12.5 $\pm$ 0.5	16.7 $\pm$ 0.6	14.8 $\pm$ 0.8	37.8 $\pm$ 0.3	
<i>Micrococcus luteus</i> MTCC 2470	15.0 $\pm$ 1.0	18.8 $\pm$ 0.3	12.9 $\pm$ 0.3	16.7 $\pm$ 0.3	12.8 $\pm$ 0.8	14.8 $\pm$ 0.8	12.7 $\pm$ 0.6	12.0 $\pm$ 1.0	16.8 $\pm$ 0.8	17.5 $\pm$ 0.5	16.3 $\pm$ 0.6	
<b>Gram-negative</b>												
<i>Salmonella typhi</i> MTCC 733	-	-	-	-	-	10.6 $\pm$ 0.6	-	-	-	-	27.7 $\pm$ 0.6	
<i>Escherichia coli</i> MTCC 43	8.8 $\pm$ 0.3	9.5 $\pm$ 0.5	10.8 $\pm$ 1.1	11.8 $\pm$ 0.3	11.7 $\pm$ 0.6	12.1 $\pm$ 0.4	-	-	-	-	-	
<i>Klebsiella pneumoniae</i> MTCC 109	-	-	-	-	-	-	-	-	-	-	-	

C1-C7: *J. communis* cultivated clones; JR: The wild species, *J. recurva*; JC: The wild species, *J. communis* and JI: The wild species, *J. indica*. Values are given as mean  $\pm$  Standard deviation (n=3).

### *Murraya koenigii*

Enhancement of essential oil recovery by improving the extraction method directly influences the industry. Comparative experiments were carried out for the analysis of chemical constituents and recovery of essential oil from *M. koenigii* leaves on laboratory scale. Using normal cleverger hydrodistillation (NC) and hydrodistillation adsorption apparatus (HDA), the recovery of essential oil was analyzed. The results showed that HDA method gave ~11% more recovery than NC method. The essential oils obtained upon analysis showed a complex mixture of mono- and sesqui-terpenes as characterized and quantified by GC, GC-MS and NMR techniques. Twenty two components of the essential oils were characterized which accounted for 92.0- 96.6% of the total composition of the oil. Both the extraction methods showed considerable overlap of the constituents. The major constituents were characterized as  $\alpha$ -pinene (28.8-39.8%, NC; 29.7-46.0%, HDA), sabinene (19.6-37.6%, NC; 24.7-40.5% HDA),  $\beta$ -pinene (5.5-8.0%, NC; 5.9-7.7%, HDA) and  $\beta$ -caryophyllene (5.4-8.1%. NC; 4.6-6.5%, HDA). Application of bigger size activated charcoal on HDA method suggests its potential in industrial application for higher essential oil recovery.

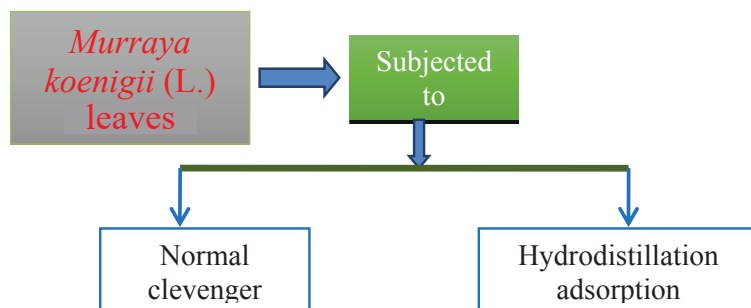

Major Components						
Compound	1st location	HAD	2nd location	HAD	3rd location	HDA
$\alpha$ -pinene	39.8	43.2	28.8	46.0	34.8	29.7
Sabinene	19.6	27.2	37.6	24.7	27.7	40.5
$\beta$ -pinene	8.0	7.7	5.5	7.8	6.1	5.9
$\beta$ -caryophyllene	5.7	5.4	5.4	4.6	8.1	6.5

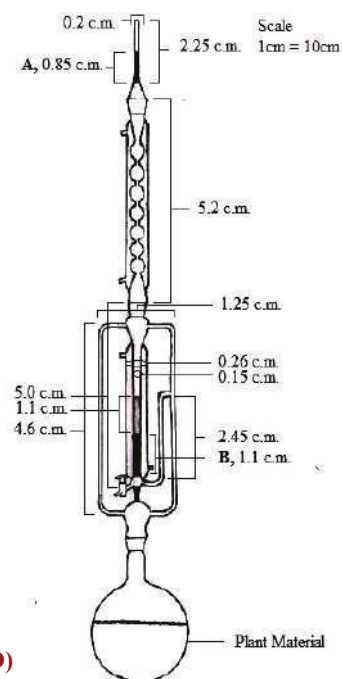

Apparatus for hydrodistillation adsorption (HAD)

## NANOTECHNOLOGY

### Supported palladium nanoparticle catalyzed $\alpha$ -alkylation of ketones using alcohols as alkylating agents

Polymer supported palladium (Pd@PS) nanoparticles (NPs) catalyzed  $\alpha$ -alkylation of acyclic, cyclic, and aliphatic ketones were performed with methanol, ethanol, and long chain alkyl and benzyl alcohols. The heterogeneous catalyst, Pd@PS was found to be highly active for most challenging small chain alkyl alcohols such as methanol and ethanol in alkylation reaction following oxidation, condensation and reduction approaches.

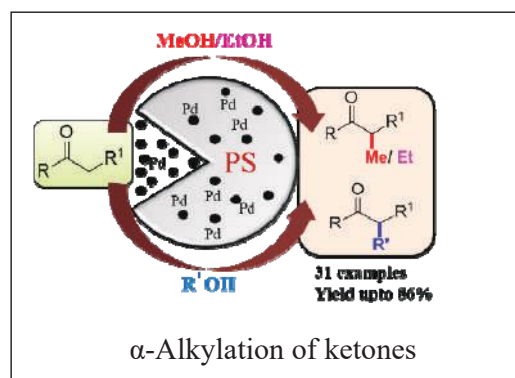

### Supported palladium nanoparticles catalyzed reductive carbonylation of nitroarenes to *N*-arylformamides

A facile reductive carbonylation reaction of nitroarenes to *N*-arylformamide synthesis was investigated under polymer supported palladium (Pd@PS) nanoparticles catalyzed conditions. Dual role of oxalic acid dihydrate (CO<sub>2</sub>H)<sub>2</sub> (2H<sub>2</sub>O) as H<sub>2</sub> source for hydrogenation and CO source for carbonylation reaction for desired products synthesis was critically investigated under favorable DMF solvent conditions.

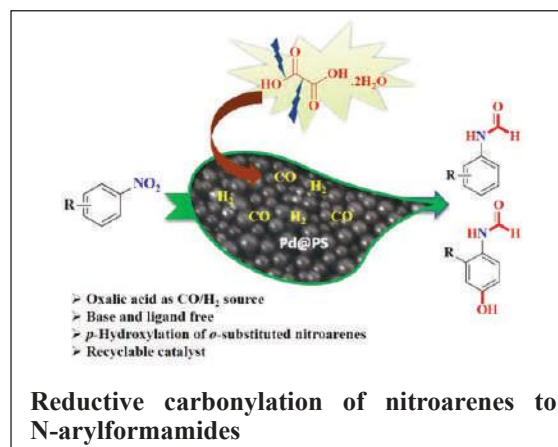

### Polystyrene supported palladium nanoparticles catalyzed cinnamic acid synthesis using maleic anhydride as a substitute for acrylic acid

Maleic anhydride was explored as a substitute for acrylic acid to synthesize cinnamic acids from aryl halides under heterogeneous palladium catalyzed conditions. The combined role of surface and impregnated catalyst together was performed to hold *in situ* generated molecules on the surface and subsequently facilitate their interaction for the desired product synthesis.

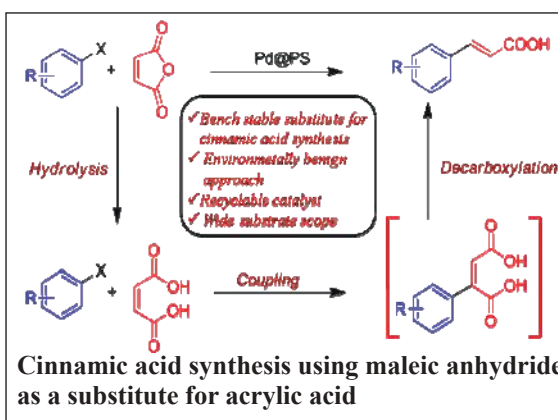

### Supported rhodium nanoparticles catalyzed reduction of nitroarenes, arylcarbonyls and aryl/benzyl sulfoxides using ethanol/methanol as *in situ* hydrogen source

A facile reduction reaction of nitroarenes, aryl carbonyls and aryl/benzyl sulfoxides was performed under polystyrene supported rhodium (Rh@PS) catalyzed conditions using ethanol/methanol as *in situ* hydrogen source. The catalyst Rh@PS played a pivotal role in the oxidation of ethanol/methanol in the presence of traces of aerial oxygen and base to produce hydrogen gas, enough for further reduction reaction.

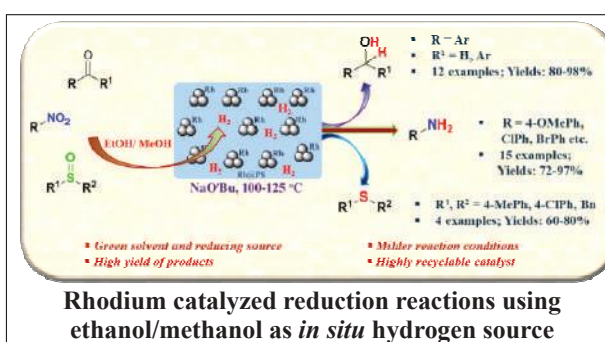

### Heterogeneous catalysis for C-N bond formation reactions

Copper iodide nanoparticles (NPs) were developed for the reductive amination of carbonyl compounds. The generated NPs were characterized by TEM, EDX, XRD and XPS analysis.

The XRD pattern, XPS, and EDX analysis confirmed that the resulted NPs were CuI instead of Cu. The TEM image of CuI exhibited the monodispersed spherical NPs in the range of  $4\pm 2$  nm. These generated NPs can be used as versatile heterogenous catalysts for important organic transformations.

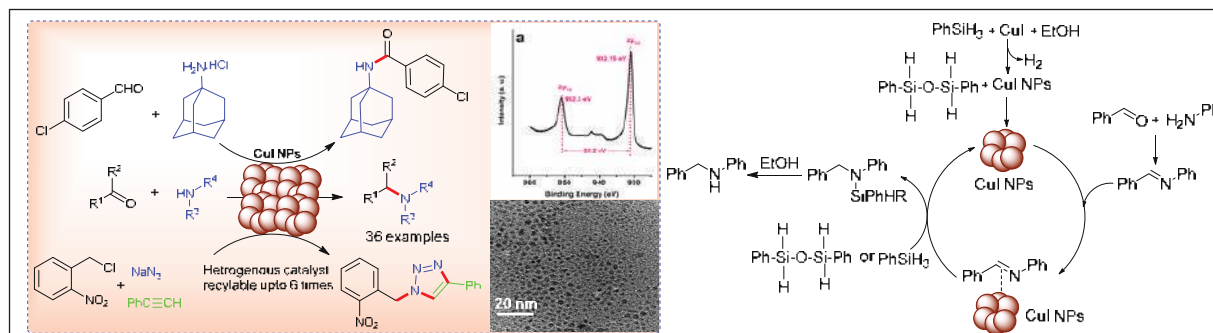

### Development of anti-microbial dressings with cellulose nanocrystals isolated from *Syzygium cumini* for accelerate acute and diabetic wound healing

The process of wound healing, nanocomposite (NCs) dressings were developed by impregnating silver nanoparticles (AgNPs) onto a matrix of cellulose nanocrystals (CNCs) isolated from *S. cumini* leaves using an environmental friendly approach. An *in situ* three step approach was embraced for topical application of NCs (ointments and strips) on acute and diabetic wounds created in mice. The NCs application enhanced tissue repair (~99% wound closure) while decreasing inflammation; increasing angiogenesis, collagen deposition, and rate of neo-epithelialization that ultimately led to the formation of aesthetically sound skin in lesser time than untreated controls. Due to the synergistic action of CNCs (having high water uptake capacity) and AgNPs (anti-microbial agents), NCs increased the expression of essential growth factors (FGF, PDGF and VEGF) and collagen, while decreasing the pro-inflammatory factors (IL-6 and TNF- $\alpha$ ) at the same time. This thereby, accelerated wound healing. The results suggested the potential of these developed anti-microbial, cytocompatible and nanoporous NCs having optimized AgNPs concentration as ideal dressings for effective wound management (Fig. 7 & Fig. 8).

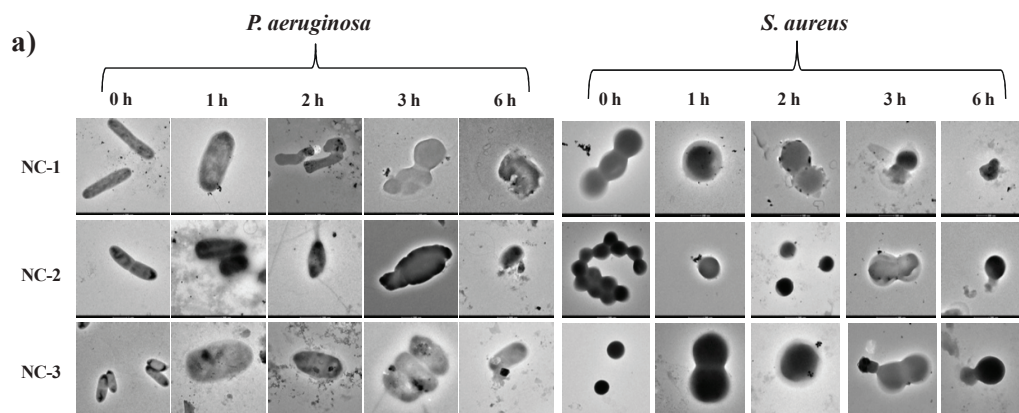
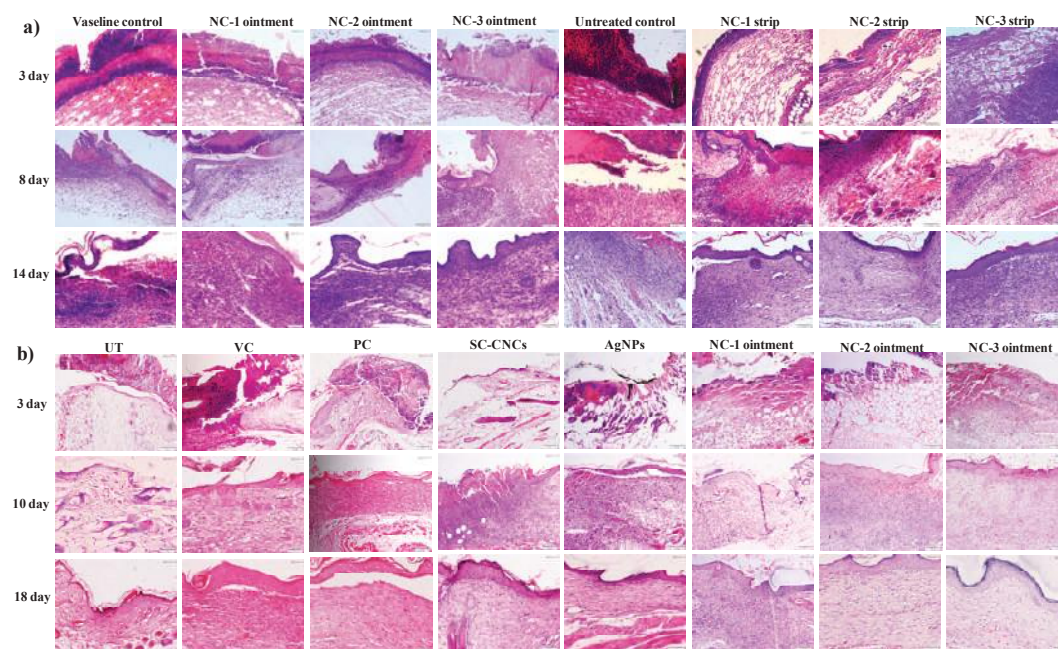

Fig. 7 Transmission electron microscopic images showing the change in morphology of *P. aeruginosa* and *S. aureus* after incubation with NC-1, NC-2 and NC-3 for different time intervals (0, 1, 2, 3 and 6h)



**Fig. 8** Bright field micrographs of hematoxylin and eosin (H&E) stained wounded skin tissue sections determining the changes in healing events in NCs treated and control mice groups (a) at day 3, 8 and 14 post wound in acute wound study and (b) day 3, 10 and 18 post wound in diabetic wound study

### Isolation of cellulose nanoparticles

Stabilized cellulose nanoparticles (CNPs) were extracted from metastable cellulose nanocrystals (CNCs). For this, CNCs were first extracted from the leaves of four different plant species by bleaching followed by alkali and mechanical treatments. The nanocrystals thus obtained were converted into CNPs by chemical methods. The synthesized CNPs were in the range of  $\sim 10 - 350$  nm and has the potential for drug delivery applications.

### Cellulose-protein nanocomposites for biomedical applications

Nanocomposites of plant cellulose nanocrystals (CNCs) were developed by binding the model proteins BSA and HSA onto CNCs by physical adsorption and chemical conjugation methods. The spectroscopy and microscopy studies confirmed the protein binding onto CNCs. Phosphate buffer saline (pH = 4.0, 7.4) and simulated gastric and intestinal fluids (SGF/SIF; pH = 1.1/6.5) showed maximum protein release of  $\sim 62\%$  over a period of time. The released proteins retained the structural integrity as well as  $\geq 90\%$  of bioactivity. The cyto-compatible nanocomposites also released  $\sim 58-85\%$  cholesterol from human umbelical vein endothelial cell (HUVEC), whereas no selectivity was observed for human coronary artery endothelial cell (HCAEC). The prepared nanocomposites having a combination of shuttles (albumins) and sinks (CNCs and albumins) and also increased cholesterol effluxing ability are potential candidates for future biomedical applications (Fig. 9).



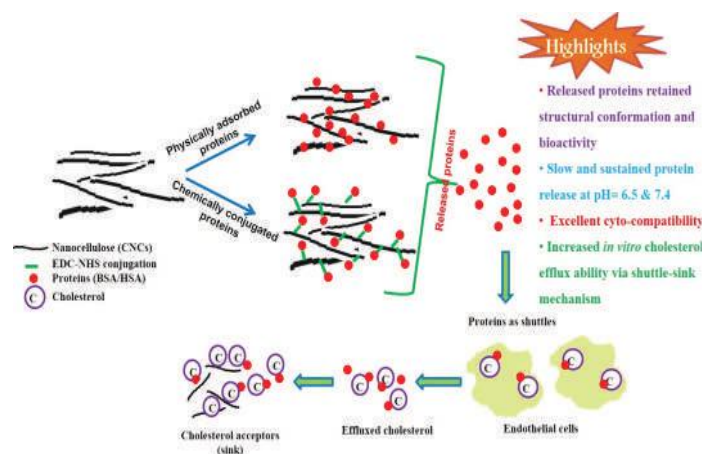

Fig. 9 Schematic diagram representing protein-CNC composite derived cholesterol efflux mechanism

### Synthesis and characterization of carbon nanomaterials

Carbon nanomaterials (CNMs) are a class of low-dimensional materials that have aroused considerable interest amongst scientists due to unusual optical, electrical, magnetic, and chemical properties as well as applications in electronics, photonics, renewable energy and biomedicine. The favorable sizes of CNMs have made them ideal nanocapsules and nanocarriers for loading as well as delivering drugs and genes to specific targets *in vivo*. Initial studies suggested that specific plant biomass can produce fluorescent carbon dots with excitation at ~440 nm and emission at ~515-520 nm under microwave heating conditions. The synthesized carbon dots are presently under investigation for use in biomedical applications.



# Health Science



## Combating Disease

### *Picrorhiza kurroa*

#### *Picrorhiza kurroa* is capable of enhancing pancreatic $\beta$ -Cell proliferation and insulin secretion in type I diabetic rats

Insulin insufficiency due to destruction of insulin producing pancreatic  $\beta$ -cells led to hyperglycemia.  $\beta$ -cells regeneration is one way of treating type 1 diabetes and combating pathologic insulin insufficiency. Previous studies reported the hypoglycemic potential of *P. kurroa*, a medicinal herb traditionally used for the treatment of various diseases but its role in treating insulin insufficiency has not been investigated. Hydro alcoholic extract of *P. kurroa* rhizome (PKRE) was characterized and used for  $\beta$ -cell regeneration and induction of insulin secretion in STZ induced diabetic rats and in insulin producing Rin5f cells.  $^1\text{H-NMR}$  revealed the presence of more than thirty metabolites including picroside I and II. PKRE treatment significantly protected the pancreatic  $\beta$ -cell against streptozotocin (STZ) evoked damage and inhibited the glucagon receptor expression (Gcgr) in hepatic and renal tissues. It significantly enhanced the insulin expression and also aided the proliferation of insulin producing Rin5f cells with elevated insulin secretion. It significantly increased insulin mediated glucose uptake in 3T3L1 and L6 cells. PKRE significantly decreased high blood glucose restored the normal levels of serum biochemicals in diabetic rats and improved hepatic and renal functions (Fig. 1 & 2).

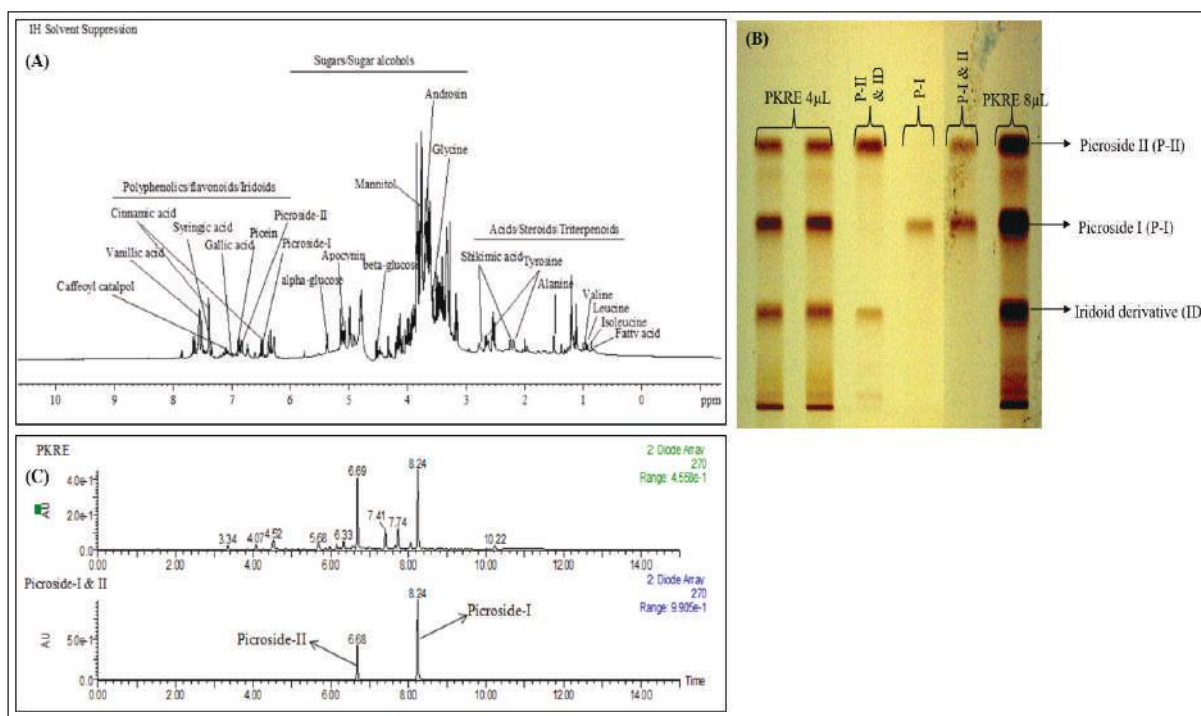
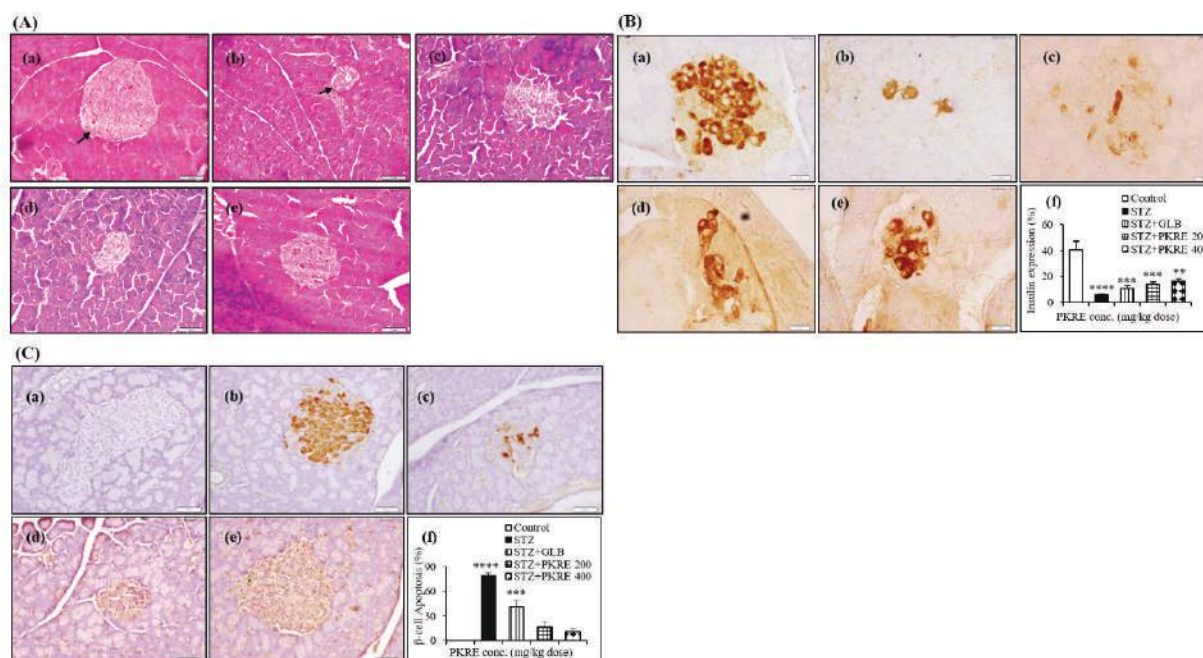

Fig. 1 (A) Chemical profiling of PKRE, (B) HPTLC fingerprint (C) UPLC-DAD chromatogram PKRE and standard mixture (Picroside I and II)



**Fig. 2** PKRE treatment significantly protected  $\beta$ -cells from STZ evoked cellular damages and enhanced insulin production in diabetic rats. (A) representative histopathological photographs showing STZ evoked  $\beta$ -cells alterations in different experimental groups detected by H and E staining. (B) microscopic images of TUNNEL assay in various experimental groups for apoptosis assessment revealed the protective effect of PKRE in diabetic rats. (C) representative immunohistochemistry images of insulin expression in different experimental groups. PKRE treatment increased the insulin expression in diabetic rats

## Ginkgo biloba

### Effect of *G. biloba* in rat model of temporal lobe epilepsy

*G. biloba* is widely used in the ethnomedical treatment of a variety of pathological and neurological conditions. It is also the main ingredient of several available phytopharmaceutical drug preparations. Thus, n-butanol fraction of hydroalcohol leaf extract was characterized using HPLC. The hydrolysed fraction showed the presence of kaempferol ( $16.32 \pm 0.12$ ) and quercetin ( $16.72 \pm 0.92 \mu\text{g}/\text{mg}$ ).

The *in vivo* investigations were conducted in epileptic rats and subjected to lithium-pilocarpine (Li-PILO). The rats with spontaneous recurrent seizures were treated for 28 days with 50 and 100 mg/kg of n-butanol fraction of *G. biloba* or vehicle. Mean seizures severity and aggression in rats were scored according to Racine's scale and different behavioural tests. Open field and forced swim tests were performed to study the effect of fraction on anxiety-like and depression-like behavior. Cognitive performance test in the epileptic rats were performed using novel object recognition and Morris water maze tests. Gene expression, protein levels and histopathological studies were carried out in the hippocampus of the rats. Rats treated with the fraction showed dose-dependent decrease in seizure severity (Fig. 3) as compared to untreated epileptic rats. There was a marked decrease in the aggression in approach response, touch response and pick up tests. The

treatment also reduced the anxiety-like behaviour in epileptic rats with no effect on depression-like behaviour. In novel object recognition test, the fraction treated epileptic rats showed more preference for novel and familiar objects. Morris water maze test results revealed significant decrease in escape latency of the epileptic rats to a hidden platform on day 4, indicating improved learning. On day 5 the treated epileptic animals showed increased movement in the target quadrant (containing the hidden platform till day 4), thus depicting improved memory functions (Fig. 4). Nissl staining showed decreased neuronal damage in the hippocampal pyramidal layer. The cornu ammonis3 and dentate gyrus of the hippocampus showed reduction in mossy fiber sprouting. The treated epileptic rats showed reduction in ribosomal S6 and pS6 proteins. The hippocampal region showed reduction in *Rps6*, *Rps6kb1* and *mTOR* mRNA levels in the *G. biloba* fraction treated animals. The protective effect of the fraction was the due to inhibition of mTOR pathway hyperactivation linked with recurrent seizures.

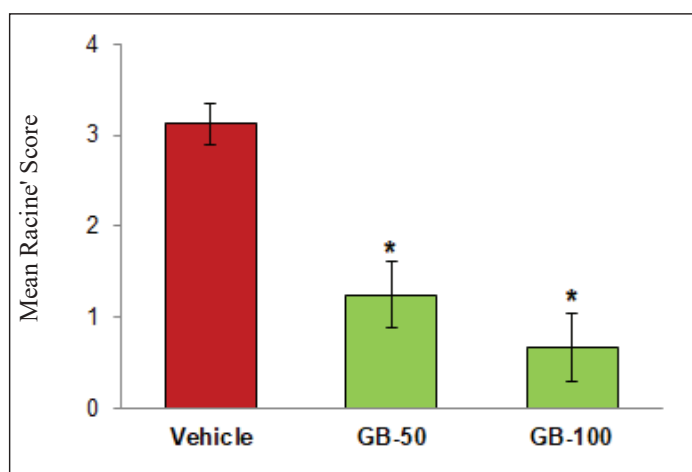

Fig. 3 Effect of *G. biloba* leaf fraction on the severity of Li-PILO-induced recurrent seizures scored using Racine's scale

### Vehicle

Vehicle control group subjected to Li-PILO; GB-50: 50 mg/kg of the extract treated group subjected to Li-PILO; and GB-100: 100 mg/kg of the extract treated group subjected to Li-PILO

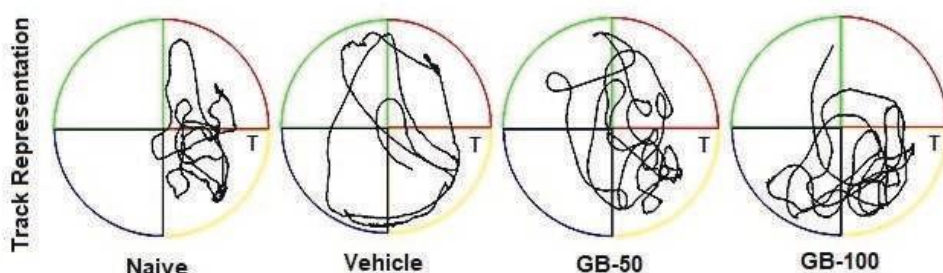

Fig. 4 Track representation of rats in Morris water maze test on day 5 indicating more movement in the target quadrant (T) in *G. biloba* leaf fraction treated groups

## Naive

Vehicle treated normal group; Vehicle: Vehicle control group subjected to Li-PILO; GB-50: 50 mg/kg of the extract treated group subjected to Li-PILO; and GB-100: 100 mg/kg of the extract treated group subjected to Li-PILO

## Mechanistic studies on iridoid glycoside from *P. kurroa*

The mechanism of action of iridoid glycosides enriched fraction isolated from *P. kurroa* was studied (Fig 5). The effect of fraction was studied following pretreatment with Bisphenol A diglycidyl ether (PPAR- $\gamma$  antagonist). The pretreatment abolished the renal and neuroprotective effects of the fraction, thus indicating its effect via PPAR- $\gamma$  mediated pathways.

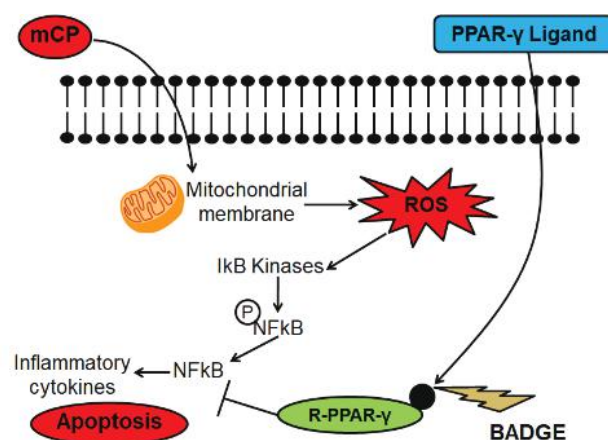

**Fig. 5** Proposed mechanism of iridoid glycosides enriched fraction of *P. kurroa* in cyclophosphamide-induced renal toxicity and peripheral neuropathy. BADGE: Bisphenol A diglycidyl ether; mCP: Active metabolite of cyclophosphamide; NF- $\kappa$ B: Nuclear factor- $\kappa$ B; and ROS: Reactive oxygen species

## Modulation of cellular immune responses and antioxidant capacity in aging mice with EGCG from Kangra tea

A systematic identification and evaluation of a synbiotic combination of epigallocatechin-gallate (EGCG) and probiotic bacteria in amelioration of immunosenescence and oxidative stress in aged mice was performed. EGCG differentially inhibited the growth of pathogenic microbes as compared to probiotic bacteria. A combination of EGCG with probiotic *Lactobacillus fermentum* (LF) provided evidence of additive effects in amelioration of oxidative and inflammatory stress induced cell death. *In vivo* study revealed that combined supplementation of LF and EGCG significantly modulated neutrophil oxidative index in aged Swiss albino animals (16 months old) CD3<sup>+</sup> and NK cells activation status, Th1/Th2 cytokines, as well as NF- $\kappa$ B and Nrf-2 expression in liver as compared to treatments with LF or EGCG alone. The combined application of EGCG and LF imposed different physiological effects as compared to individual supplements, but did not result in additive or synergistic effects. EGCG can thus be considered as a potential prebiotic offering second generation symbiotic health beneficial effects and amelioration of deleterious effects of aging and immunosenescence (Fig. 6 and Fig. 7).



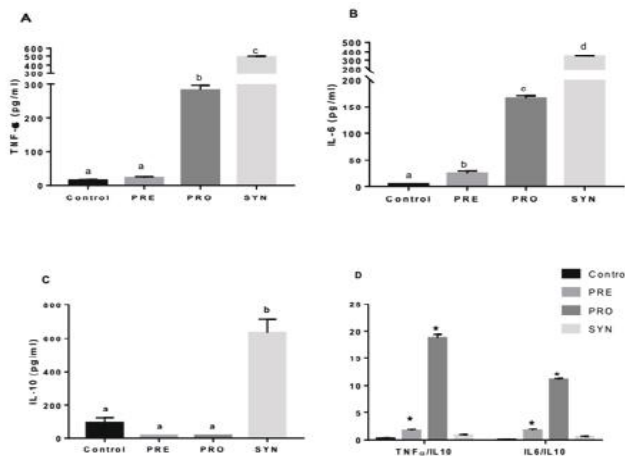

Fig. 6 SYN supplementation maintains dynamic balance between Th1/Th2 cytokines

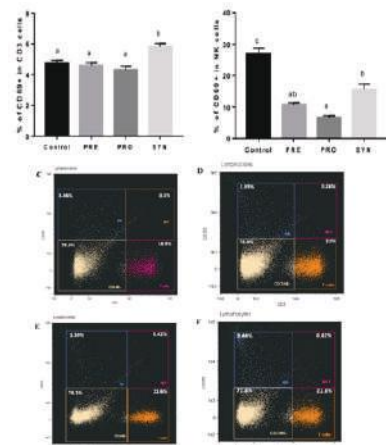

Fig. 7 Differential activation of T cells by SYN

**Idiopathic Pulmonary Fibrosis**

Idiopathic Pulmonary Fibrosis (IPF) is an incurable progressive fibrotic disease of the lungs for which there is no systematic understanding at present. Systems approach may offer new therapeutic insights into the disease. Therefore, a large volume of high throughput genomics data was unified for the first time to derive the most common molecular signatures of IPF. Results revealed a set of 39 differentially expressed genes (DEGs) critical for IPF. Using high confidence evidences and experimental data, system level networks for IPF were reconstructed involving 737 DEGs common to at least two independent studies. This provided one of the most comprehensive molecular system views for IPF and underlined the associated regulatory and molecular consequences. Fifty six pathways crosstalks were identified including critical pathways with specified directionality. The associated steps gained and lost due to crosstalk during IPF were also identified. After comparison with NSIP and Sarcoidosis, a serially connected system of five crucial genes was found to be potentially controlled by nine miRNAs and eight transcription factors, exclusively in IPF. Findings of the

IPF Phenotype

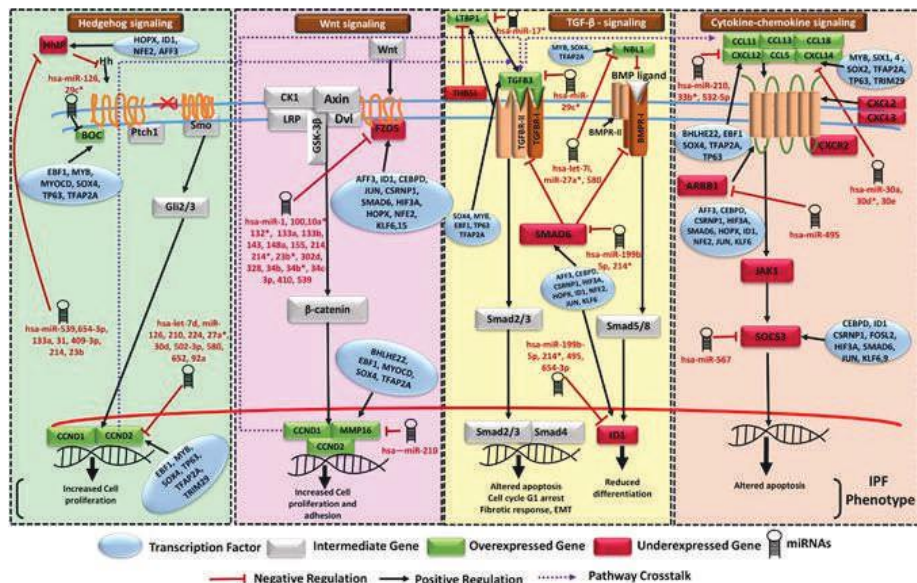

Fig. 8 The IPF specific pathway cross talks. A drastic shift was observed from normal to early stage of IPF. Such a shifts could be useful for early diagnosis of IPF

study were implemented into a comprehensive molecular and systems database on IPF in order to facilitate diagnostic and therapeutic solutions for this deadly disease. Experimental validations using cell lines and western blotting confirmed the role of identified miRNAs in IPF.

# Food and Nutraceuticals



## READY TO EAT FOODS

### Development of Khichdi-A Sattvic Food

The global ready-to-eat (RTE) meals market was valued at US \$ 85 billion in 2015. This market is expected to grow at a CAGR of 5.0% from year 2015-2020. With the change in consumer preference, the demand for shelf-stable products is increasing. Consumers are rapidly adapting to convenient portion packs of hygienic, branded and well packaged food products. Reduction of heating time by 30-50% with improved food appearance, better nutrition and taste are the main factors popularizing regional based product in convenient packaging in India. Estimated value of the ready to eat industry will be worth approximately INR 6,405 million (~USD 106.7 million) by FY 2020.

In this regard, an indigenous technology for commercial production of ready-to-eat Khichadi developed was using authentic Himalayan variety of moong dal, split mung beans (or dal) and traditional mountain rice varieties without adding any preservatives. The greatest advantage is of these products is the fact they remain fresh for seven months without any loss in taste or flavour.

### Nutritionally rich fruit bar to combat malnutrition

The prevalence of malnutrition in India is one of the highest in the world, affecting about 43% children below the age of five & 36% hard working women. In this regard, CSIR-IHBT developed nutritious “Nutribar” rich in calcium and iron from low cost affordable raw materials. The fruit bar and nutri mix can combat malnutrition especially among women and children. Research investigations show that the fruit bar meets 40% of RDA requirement of iron among selected population. The fruit bar is rich in iron, vitamin C and antioxidants and has a shelf-life of up to six months. The product has health promoting attributes of natural resources, which are otherwise lost during cooking through conventional techniques.

The technology for making Nutribars is cost effective affordable and involves bioresources available in western Himalayan region (Fig. 1).



**Fig. 1 Iron and calcium rich Nutribar**

The developed product was disseminated to a group of anaemic children and women. The results are given as Fig. 2 below.

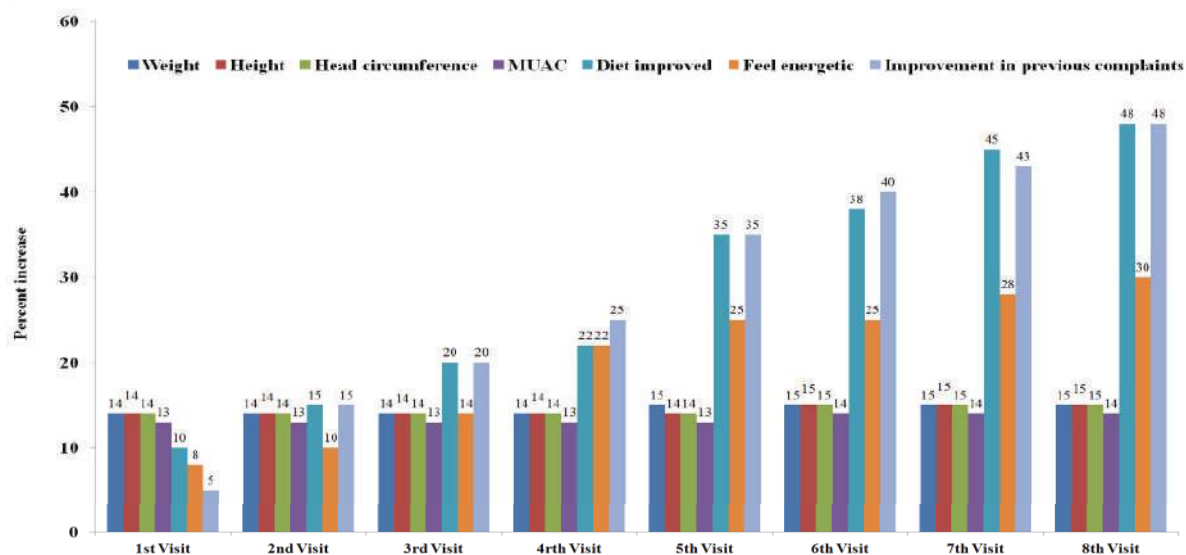

**Fig. 2** Effects of Nutri-Bar in 6-19 years age group female volunteers at vill. Ahmadpur, Raibareilly

### Cereal and nut based granola bars and energy bars

An indigenous process technology for commercial production of ready to eat cereal/nut based granola and energy bars were developed. The product has an average shelf life of about 6 months but has no added preservatives.

- The bars are multi grain, 100% natural fruit based products. It can provide 4 to 5 g protein, 3 g complex dietary fibre, < 6 g sugar and saturated fat content < 2.5 g/per serving. Its calcium content can cater to 15 to 20% of RDA

Being a concentrated source of energy and protein, the bars can be served as ready to eat healthy snacks for pre-schoolers, school children, adolescent girl children, pregnant women, sports enthusiasts and athletes.

### Ingredients

The ingredients of the products comprise of whole grains like brown rice, little millet, foxtail millet, oats, honey as sweetener, nuts like almonds, cashews, dates, cranberry, raisins, dehydrated fruit powders, rice bran oil, natural vitamin E, i.e. natural fruits like tocopherols and rosemary extract

### Nutrition facts\*

Parameters	Amount per serving	% DV
Calories (Kcal)	170	8.5
Total carbohydrates (g)	22 - 25	20
Sugar (g)	6	-
Dietary fiber (g)	3 - 4	10%

Parameters	Amount per serving	% DV
Protein (g)	4 - 5	8.3%
Total fat (g)	6.3	10%
Calcium (mg)	28.6	5%

\* Calculated based on RDA for adult man on a 2000 Kcal diet as per Dietary guidelines of ICMR-NIN, India & Nutritive Value of Indian Foods, ICMR-NIN. DV – Daily Value; RDA – Recommended Dietary Allowances; ICMR-NIN – Indian Council of Medical Research-National Institute of Nutrition

### Ready to Eat spirulina bar

Blue green alga (cyanobacterium) extensively consumed as a popular health food and a dietary supplement throughout the world. Spirulina is a concentrated source of protein, vitamins, especially B<sub>12</sub>, provitamin A (β carotene) and vitamin E and minerals, especially iron. It is also rich in gamma linolenic acid (GLA), an omega 6 fatty acid.

The product can be supplemented to pre-schoolers, school going children, adolescent girl, pregnant mothers as a fortified snack enriched with energy, protein and micronutrients. The product can be utilized in nutrition supplementation programmes- Integrated Child Development Services (ICDS) such as mid-day meal schemes. It is made of peanuts, jaggery, *Spirulina platensis* spray dried powder, sugar syrup, ginger extracts and cardamom powder. The energy content of each ingredient is as per FSSAI norms (Table 1 & Fig. 3).

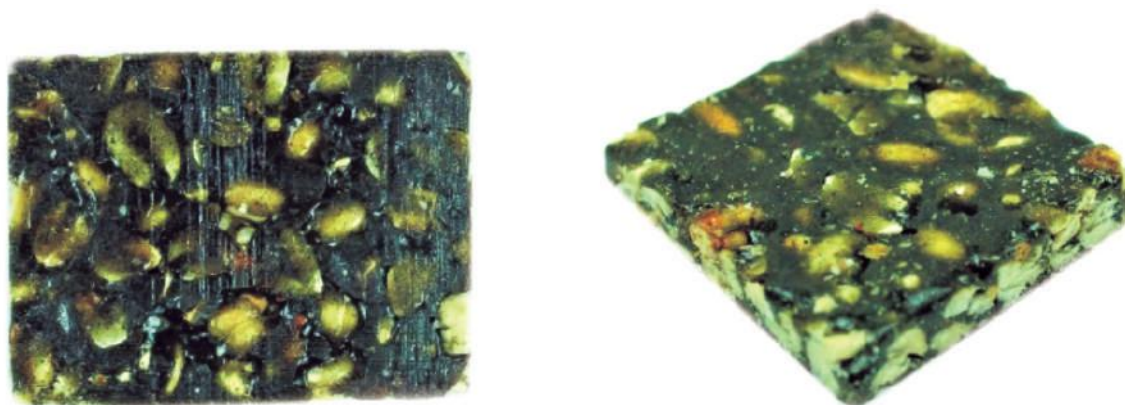

Fig. 3 Spirulina peanut bar

Table 1 Energy content of ingredients of Spirulina bar

Energy (Kcal)	351 Kcal
Fat (g)	17.6
Calories from fat (Kcal)	140.8
Protein (g)	8
Carbohydrates (g)	41.2
Sugar (g)	35

The bar is specially nutritious because of the presence of Spirulina

### **Characterization of pulp and seeds of high altitude Himalayan crab apple fruits (*Malus baccata*)**

Phytochemicals in fruits and vegetables achieved immense significance owing to their antioxidant property and ability to prevent of chronic diseases.

The fruits of *M. baccata* commonly known as ‘wild apples’ or ‘crab apples’ are rich in phenolic compounds and have higher antioxidant activity than seeds. Free amino acids like serine (9.061 g mg<sup>-1</sup>), alanine (8.031 g mg<sup>-1</sup>), tyrosine (10.331 g mg<sup>-1</sup>), and cysteine (76.861 g mg<sup>-1</sup>) were detected in pulp, while seed comprised of histidine (3.961 g mg<sup>-1</sup>) only.

The amount of phloretin (88.39 µg/mg) and phloridzin (83.03 µg/mg) were higher than other phenolics determined using UPLC. Detailed phytochemical profiling showed that *M. baccata* is a good source of antioxidants, essential fatty acids, amino acids and sugars. The product is potential health-promoting functional food and a nutraceutical product.

### **Characterisation of antioxidant rich peptides from green sorghum**

Sorghum is an important cereal crop for the people who live in desert and semi-arid areas. Sorghum is gluten-free, and possesses anti-inflammatory, cholesterol-lowering, and anti-colon cancer properties. Antioxidant peptides in green tender sorghum can be utilized for health related nutraceutical development after enzymatic hydrolysis.

- The molecular mass and amino acids sequences of the purified peptides were identified using matrix assisted laser desorption ionization time-of-flight mass spectrometer (MALDI-TOF-MS/MS).
- The molecular weight distribution of the peptides from fractions F2B (875.5 Da) and F3A (858.5 Da) revealed higher antioxidant activity with 74.19% and 77.64% of inhibition, respectively.

### **Healthy snacks formulation from hull-less barley of high altitude region**

Barley (*Hordeum vulgare*) is a winter crop mainly used for food and feed. It is an excellent source of β-glucan fiber with low glycemic index that it helps in lowering cholesterol and preventing diabetes. Therefore CSIR-IHBT developed extruded snacks by incorporating different proportions of hull-less and hulled barley into rice flour using single screw extruder under pre-optimized conditions. The prepared products were analyzed for their nutritional, functional, colorimetric textural and physical (Fig. 5) properties. Physico-chemical analysis of the different formulations showed an increase in crude protein, total fat, crude fiber and total ash in hull less barley from 8.01 to 9.01, 0.73 to 1.04, 0.77 to 1.14 and 0.55 to 0.99 respectively, increasing the quantity of hull less barley, and 8.01–8.85, 0.73–1.02, 0.77–1.38 and 0.55–1.01% respectively for hulled barley. The color of extruded snacks turned darker on adding barley flour and trend goes on. Water absorption index as well as water solubility increased with the increase in moisture content of raw material (Fig. 4). The puffed snacks showed better nutritional profile as compared to puffed snacks prepared from rice only.



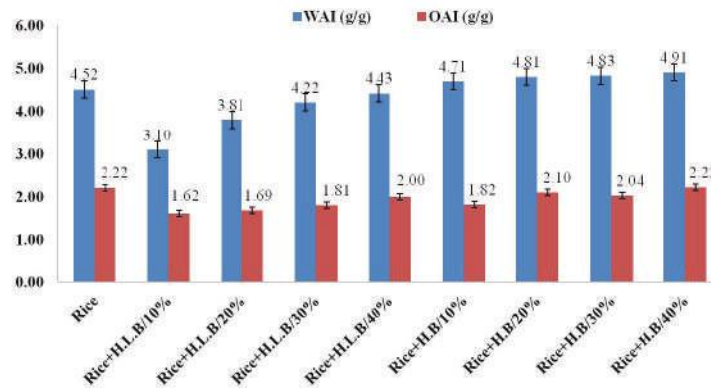

Fig. 4 Water absorption and oil absorption index of extruded puffed snacks

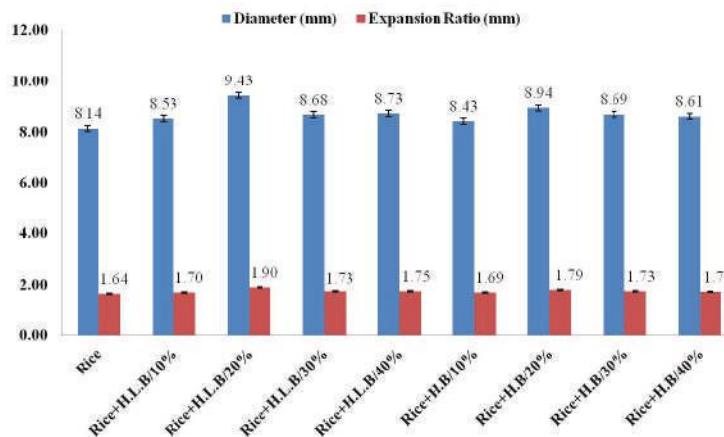

Fig. 5 Physical parameters of extruded puffed snacks

### Formulation of punicalagin rich extrudates using pomegranate peel extract

Free and bound phenolics of pomegranate peel and rice extruder snacks with punicalagin incorporation in it were compared. Total phenolic content was higher in the rice extruded snacks. However, the residual bound phenolics was 97.62 mg GAE/g and 92.56 mg GAE/g respectively. Higher content of total flavonoids content was also recorded in the rice extruder snacks. In DPPH test, the IC<sub>50</sub> value of free and bound phenolics of fresh pomegranate peel were 7.05 and 4.95 µg/ml, respectively (Fig. 6).

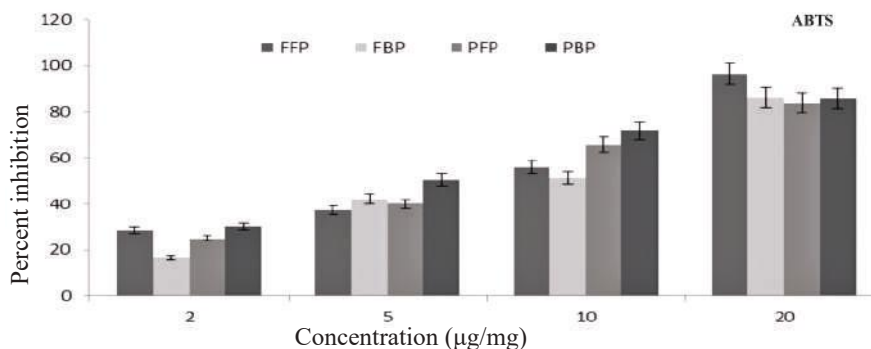

Fig. 6 ABTS free radical scavenging activity of free / bound phenolic extracts

Fresh free phenolics (FFP), fresh bound phenolics (FBP) product free phenolics (PFP) product bound phenolics (PBP). (ABTS; 2,2'-azino-bis (3-ethylbenzothiazoline-6-sulphonic acid) and DPPH; (2,2-diphenyl-1-picrylhydrazyl) free radical scavenging activity.

HPLC analysis also showed the presence of punicalagin in pomegranate peel extract and extruded snacks in its free (0.01 mg/g) and bound (0.09 mg/g) forms. Other phenolics like *p*-coumaric acid (1.28 mg/g), gallic acid (0.08 mg/g), cinnamic acid (0.48 mg/g) and quercetin (0.06 mg/g) were present in bound extracts of extruder products.

The overall results demonstrated that pomegranate peel contains good amounts of phenolics in its free and bound fraction forms and exhibited good antioxidant activity. Phenolics were successfully incorporated final chromatographic studied showed sufficient amounts of punicalagin in rice extruded snacks.

### **Isolation of potential probiotics from traditional fermented foods of Lahaul region**

In another activity, the traditional fermented foods were investigated for potential probiotics and food formulations. Seventeen fermented food samples were collected from Upper Sumnam, Phunkiyyar, Urgosh and Sukto villages of Lahaul area. The samples were analysed for isolation of bacteria for prospective use in probiotic food formulations. The pH of milk based fermented products ranged from 4.1 to 4.5, whereas, that of Lugri samples (un-distilled alcoholic beverage) ranged between 3.3 to 3.6. Unique morphotypes from each samples were obtained at 20 and 37° C, whereas, no colonies were obtained at 10° C. In total, 265 unique morphotypes of bacteria were purified and preserved from traditional fermented foods. Probiotic attributes such as bile tolerance, acid tolerance and antimicrobial tests were performed, and 25 potential probiotic strains were identified. These have potential for probiotic and functional food formulations.

### **Organic acids**

Organic acids are non-volatile natural compounds abundantly present in various fruits, vegetables and plant products. Citrus fruits are rich source of natural organic acids. These phytochemicals are also used in processed foods, and instant beverages. An RP-HPLC method was developed using buffer free solvent system for rapid quantification of major organic acids from citrus fruits and derived products. Method validation studies showed linearity for all organic acids (oxalic, tartaric, ascorbic, malic, citric and succinic acids). The developed method was validated for linearity, sensitivity, precision, accuracy, specificity and robustness. Local citrus fruits of the region like *Citrus aurantifolia*, *C. nobilis*, *C. ichangensis*, *C. karna*, *C. medica*, *C. limetta* and *C. aurantium* were assessed for organic acids, total phenolics, free radical scavenging antioxidants and antimicrobial potential against selected bacterial and fungal strains (*Bacillus subtilis* (MTCC 721), *Staphylococcus aureus* (MTCC 3160) and *Escherichia coli* (MTCC 43), *Klebsiella pneumonia* (MTCC 109) and two fungal strains i.e. *Aspergillus niger* (MTCC 404) and *Candida albicans* (MTCC 3017). The results showed appreciable amounts of phenolics and antioxidants in all juice samples, besides showing significant antifungal activity against *C. albicans* and *A. niger* strains. However, only *C. aurantifolia* showed inhibitory effects against selected strains of microbes. The study revealed that citrus fruits have huge potential for application as commercial source of natural OAs (Fig. 7).

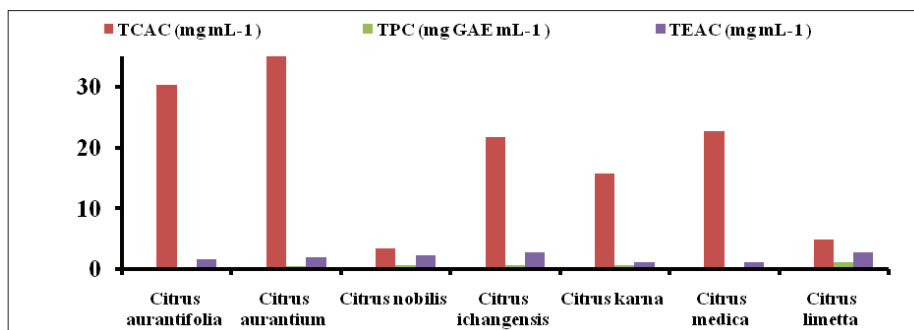

Fig. 7 Total citric acid (TCAC), phenolic content (TPC) and antioxidant activity (TEAC) of juice samples

### Algae Culture Facility

Establishment of an algae culture facility and germplasm repository was initiated at CSIR-IHBT. A total of 10 different fresh water strains of unialgal were also isolated and maintained axenically under autotrophic conditions. The algal strains such as *Spirulina platensis*, *Chlorella pyrenoidosa*, *C. sorokiniana*, *S. acutus*, *S. obliquus*, *Scenedesmus abundans*, *Monoraphidium* sp., *Desmodesmus* sp., *Ankistrodesmus* sp. were identified morphologically (Fig. 8).

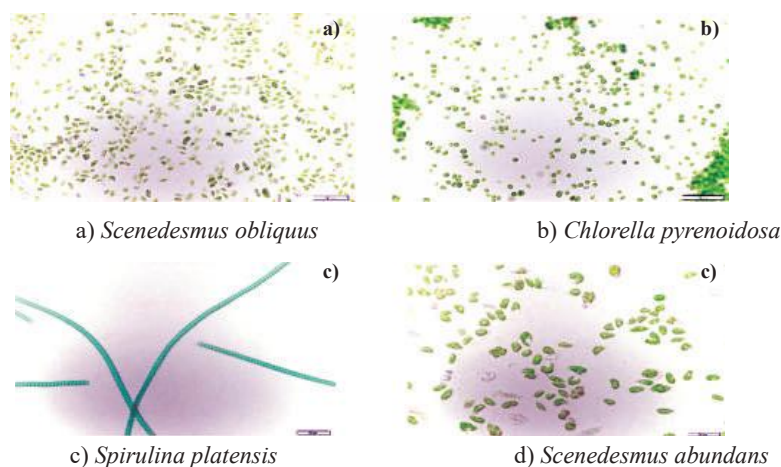

Fig. 8 Photomicrographs of microalgae cultures

### Characterization of micro algae strains for prospection of important nutraceuticals

Micro algae strains were characterized for their growth and nutrient requirements. The strains having both nutraceutical and food colorant applications were evaluated for their carotenoid and phycobiliproteins (phycocyanin) composition (Fig. 9-11).



Fig. 9 Crude extract of phycocyanin from *S. platensis* dry powder

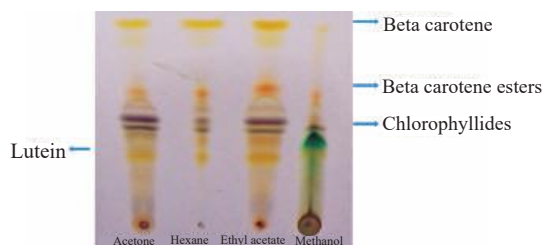

Fig. 10 Chromatogram showing separation of various pigments from microalgae biomass

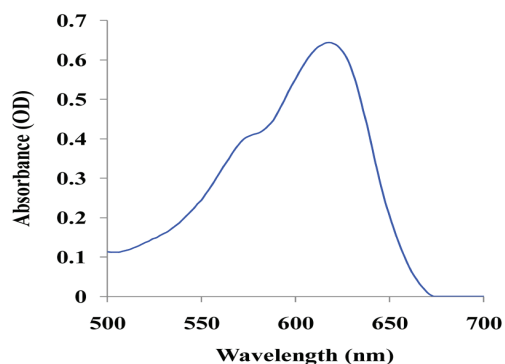

Fig. 11 Absorption spectra of phycocyanin extracted from *S. platensis*

### **Toxicity studies**

Safety and toxicity testing is an important part of product development. Thus, the Institute is involved in the toxicity testing and efficacy evaluation of natural drug molecules, nutraceuticals and nanomaterials. During the current year the oral and dermal safety of products like sapium wax and oil, products derived from tagetes oil and creams for dermal applications were tested.

Safety testing of Superoxide Dismutase using OECD guidelines 236 (Fish Embryo Acute Toxicity) were mainly carried out.

### **Development of animal models**

Development of animal models is an essential step to check efficacy of developed products, formulations or drugs and also for understanding the mechanism of disease progression. Hence, animal models were developed for various human diseases. In this regard, the biologically relevant heterotopic xenograft model of HNSCC in immuno compromised mice (NOD/SCID mice) and mice model for bleomycin induced idiopathic pulmonary fibrosis, a highly fatal chronic, progressive lung disease were developed.

### **Management of animal breeding and housing facility**

The thoroughbred laboratory animals of different strains were maintained and produced in the institute animal home facility. This year also animals are provided to Dr. G. C. Negi College of Veterinary and Animal Sciences, CSKHPKV, Palampur and Khalsa College of Pharmacy, Amritsar.

## *High Value Crops*



## SAFFRON (*Crocus sativus*)

### Saffron cultivation in regions around Palampur (H.P.) for generation of healthy disease free planting materials (corms) of commercial size

Saffron or zafran is the costliest spice crop of the world with price ranging between 1100-11000 US\$ /kg. The crop is grown in regions as diverse as Iran, Azerbaijan, Greece, Spain, Argentina, China, Japan etc. Yet, the best quality saffron comes from Kashmir in (India).

In India the yield of saffron has suffered severely from rapid urbanization, climate change, frequent incidence of natural calamities and corm rot diseases. A 184% decline in yield in just a span of 12 years was reported. India cannot fulfill its own demand. Therefore, it imports the spice in order to cater to its annual demand of 40 tonnes. A major reason is the acute un-availability of requisite amount of good quality corms (Fig. 1).

In this regard, an efficient tissue culture protocol was developed for the production of healthy and disease free corms (>5.0 g each) of saffron. These corms have the potential to grow into planting material of commercial size (about 10 g or more) in just two growing seasons.

In another approach, farmers involved in wheat and rice cultivation were roped in to grow saffron for generation of quality planting material in five different regions around Palampur, Kangra district (H.P.) as locales alternative to Kashmir. Enhancement of corm size from initial 6.0 to 8.0 g to a final size of 19.0 to 21.0 g was achieved in these regions using agro-technological interventions. It was concluded that regions around Palampur are suitable for generation of quality planting material of commercial size (Fig. 2).



Fig. 1 *In vitro* production of healthy disease free corms



Fig. 2 Saffron cultivation in Kangra district of H.P. for the generation of healthy disease free corms of commercial size

### Characterization of microflora of rhizosphere associated with saffron

In India, saffron is produced in Kashmir and Kishtwar region of Jammu, thereby contributing towards only 10% of the demand for saffron spice. Almost 90% saffron is imported from abroad. Thus, there is an opportunity to expand saffron production in India by cultivating

the crop in new unexplored potential areas. In this regard, in the previous years, work on the development of consortia of plant growth promoting rhizobacteria (PGPR) was initiated to enhance the growth and productivity of saffron. A few prospective rhizobacteria with plant growth promoting attributes were characterized and pot trials were performed. In the current year, the effect of these PGPRs on saffron growth and corm production were assessed by initiating field trials. The corms treated with the formulation based on charcoal were sown in the farmer's field at Devikhet, Dehradun (Uttarakhand), Pangi valley, Chamba (H.P.) and CSIR-IHBT experimental farm field. In order to have larger bulb production, the PGPR treated corms sown at Pangi were not harvested despite excellent growth. Data on the performance of PGPR treated saffron corms growing at CSIR-IHBT experimental farm showed at par growth of PGPR treated and control corms when 50% NPK+FYM were used. In contrast, daughter corms >8 g were obtained at Devikhet, Dehradun (Fig. 3A&B). The combination of PGPR1+PGPR2+FYM and PGPR1+PGPR3+FYM treated corms showed excellent result across all the parameters and were at par with 100% NPK+FYM (Farm Yard Manure).

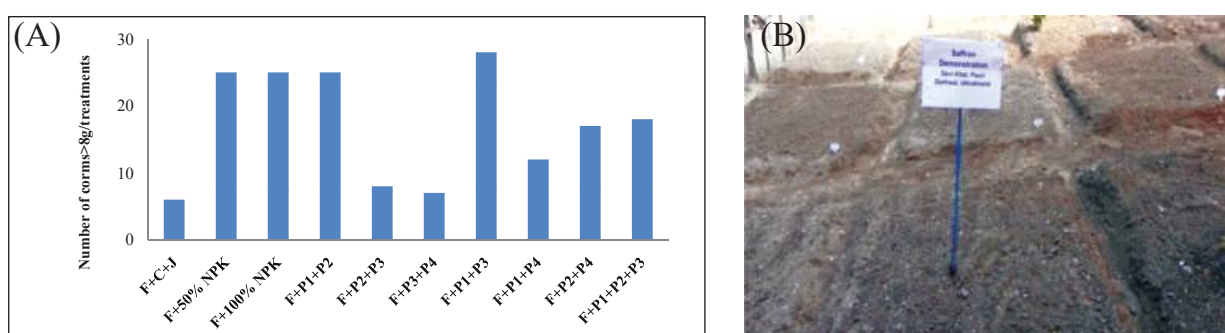

Fig. 3A&B Performance of PGPR treated saffron grown at Devikhet (Dehradun) [(F: Farm Yard Manure; C: Charcoal; J: Jaggery) (P1= PGPR-1; P2= PGPR-2; P3= PGPR-3; P4= PGPR-4)]

### Saffron introduction in non traditional areas

Saffron crop was introduced in nontraditional areas *viz.*, Bharmour and Pangi in Chamba district, Padhar in Mandi district, Sainj in Kullu districts of Himachal Pradesh, Devikhet, Silogi and Kandai villages in Pauri Gharwal district in Uttarakhand to find alternate sites for growing saffron crop (Table 1). Flowering was observed in Bharmour and Pangi of Chamba district in Himachal Pradesh (Fig. 4). Multilocation sites were evaluated and maximum weight of large size (22.2 g), medium size (13.2 g) and small size (6.8 g) corms at CSIR-IHBT Palampur as compared to other locations.

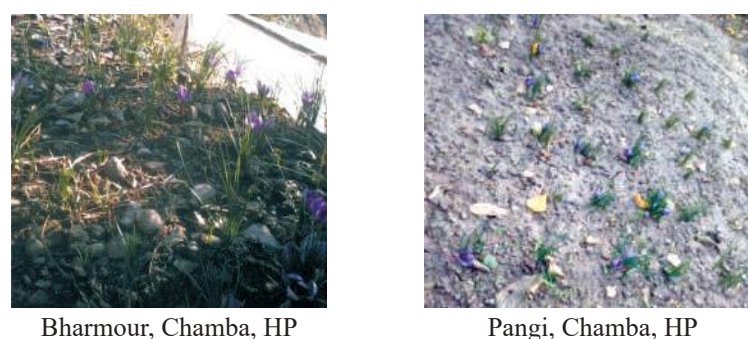

Fig. 4 Saffron introduction in non traditional areas



**Table 1 Introduction of saffron in different sites**

Location	Altitude	Latitude	Longitude
Village Jiwa ,Teh.- Sainj, Kullu, HP	1409 m	31° 47' 11 '' N	77° 19' 39 '' E
Village Jiwa , Teh-Sainj, Kullu, HP	1417 m	31° 47' 11 '' N	77° 19' 39 '' E
Village Remu, Teh-Nirmand, Kullu , HP	1638 m	31° 27' 23.8 ''N	77° 34' 24 '' E
Village Kajotdhar, Teh- Padhar, Mandi, HP	1898 m	31° 51' 18 '' N	76° 56' 52 '' E
Village Kandiyar, Teh-Padhar, Mandi , HP	2000 m	31° 31' 27 '' N	76° 54' 55 '' E
Village Supa, Teh-Bharmour, Chamba, HP	2133 m	32° 11' 54 ''N	76° 35.7'31 E
Village Bhareri, Teh-Kothgarh, Shimla, HP	2206 m	31° 18' 13.3'' N	77° 29' 2.6'' E
Kilar, Teh- Pangi, Chamba, HP	2400 m	33° 08' 14 '' N	76° 9' 8 '' E
Village Devikhet, Distt- Pauri Garwal, UK	1555 m	29° 54' 34.7 '' N	78° 33' 15.1'' E
Village Silogi, Distt- Pauri Garwal, UK	1765 m	29° 59' 55.6 '' N	78° 34' 44.9 '' E
Village Kandai, Distt. Pauri Garwal, UK	1800 m	29° 59' 55.6 '' N	78° 34' 44.9 '' E

## STEVIA

### Elimination of bitter off-taste in stevioside through chemical modification and computational intervention.

Stevioside holds an essential place under sweeteners segment owing to its benefits such as low-calorie and high protein ingredient. It is a natural sweetener with a proven market potential. In the present study, key moieties of stevioside was modified to remove the bitter off-taste without compromising on sweetness.

### Establishment of cell suspension culture for the production of rebaudiosides in Him Stevia

Different strategies were used to enhance the production of rebaudioside-A content in *in vitro* grown plants and cell suspension culture. *In vitro* grown leaf explant was used for the establishment of the callus culture. Then, callus cell lines were screened for high metabolite yield. The cell suspension culture was further used for the production and enhancement of metabolites content (Fig. 5).

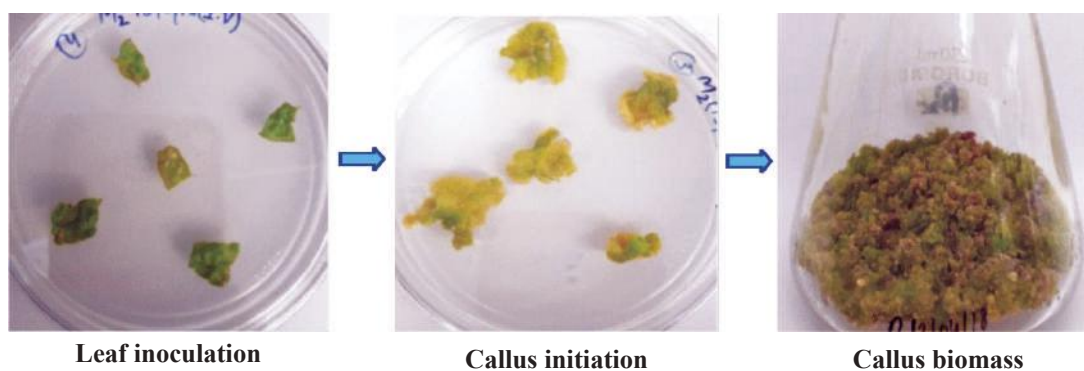

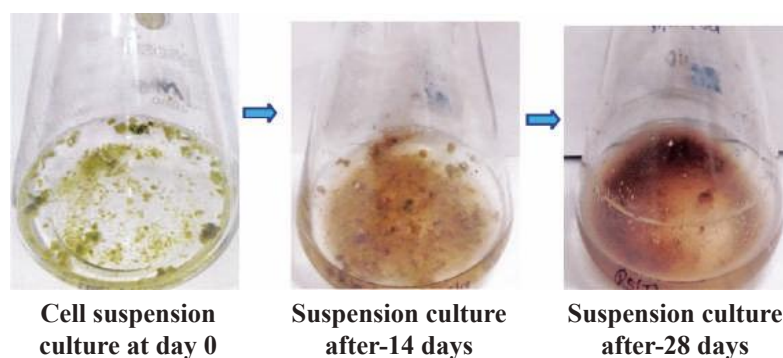

Fig. 5 Callus proliferation and suspension culture of *S. rebaudiana*

### Use of elicitors for enhancement of steviol glycoside content

In order to enhance the steviol glycoside content in micropropagated *S. rebaudiana* plants, nodal explants were inoculated on medium containing different elicitors such as chitosan and salicylic acid of various concentrations. Effect of elicitor on *in vitro* shoot growth and biomass production was then studied (Tables 2 & 3).

**Table 2** Effect of elicitor types and concentrations on *in vitro* shoot growth of *S. rebaudiana* after 4 weeks of culture

Elicitors used	Elicitor concentration (g/l)	Average shoot (no.) (Mean $\pm$ S.E.)	Average shoot length (cm) (Mean $\pm$ S.E.)	Average root no. (Mean $\pm$ S.E.)	Average root length (cm) (Mean $\pm$ S.E.)	Average no. of leaves (Mean $\pm$ S.E.)
Control		2.37 $\pm$ 0.07 <sup>ab</sup>	3.71 $\pm$ 0.80 <sup>b</sup>	2.93 $\pm$ 0.23 <sup>ab</sup>	0.57 $\pm$ 0.24 <sup>a</sup>	17.07 $\pm$ 3.08 <sup>c</sup>
	0.5	1.70 $\pm$ 0.58 <sup>ab</sup>	2.33 $\pm$ 0.35 <sup>ab</sup>	1.23 $\pm$ 0.62 <sup>ab</sup>	0.29 $\pm$ 0.21 <sup>a</sup>	10.90 $\pm$ 3.00 <sup>abc</sup>
	1	1.77 $\pm$ 0.20 <sup>ab</sup>	2.39 $\pm$ 0.54 <sup>ab</sup>	1.57 $\pm$ 1.10 <sup>ab</sup>	0.19 $\pm$ 0.12 <sup>a</sup>	9.33 $\pm$ 1.68 <sup>abc</sup>
	1.5	2.47 $\pm$ 0.62 <sup>b</sup>	2.92 $\pm$ 0.55 <sup>ab</sup>	3.34 $\pm$ 1.27 <sup>ab</sup>	0.33 $\pm$ 0.00 <sup>a</sup>	14.58 $\pm$ 3.31 <sup>ab</sup>
	2.0	2.11 $\pm$ 0.49 <sup>ab</sup>	2.63 $\pm$ 0.91 <sup>ab</sup>	2.33 $\pm$ 1.36 <sup>ab</sup>	0.27 $\pm$ 0.18 <sup>a</sup>	12.47 $\pm$ 3.54 <sup>abc</sup>
Salicylic acid	0.5	1.67 $\pm$ 0.20 <sup>ab</sup>	1.87 $\pm$ 0.12 <sup>ab</sup>	0.10 $\pm$ 0.10 <sup>a</sup>	0.33 $\pm$ 0.33 <sup>a</sup>	7.67 $\pm$ 1.60 <sup>abc</sup>
	1	1.53 $\pm$ 0.30 <sup>ab</sup>	2.80 $\pm$ 0.40 <sup>ab</sup>	1.87 $\pm$ 0.72 <sup>ab</sup>	0.33 $\pm$ 0.13 <sup>a</sup>	10.13 $\pm$ 2.24 <sup>abc</sup>
	1.5	1.00 $\pm$ 0.00 <sup>ab</sup>	1.53 $\pm$ 0.14 <sup>ab</sup>	2.13 $\pm$ 0.09 <sup>ab</sup>	0.17 $\pm$ 0.03 <sup>a</sup>	2.40 $\pm$ 1.33 <sup>ab</sup>
	2.0	1.00 $\pm$ 0.23 <sup>ab</sup>	1.14 $\pm$ 0.12 <sup>a</sup>	0.44 $\pm$ 0.44 <sup>ab</sup>	0.07 $\pm$ 0.07 <sup>a</sup>	0.53 $\pm$ 0.41 <sup>a</sup>

**Table 3** Effect of elicitor types and concentrations on biomass production of *S. rebaudiana* after 4 weeks of culture

Elicitors used	Elicitor concentration (g/l)	Total weight of shoots (mg)		Total weight of roots (mg)	
		Fresh wt.	Dry wt.	Fresh wt.	Dry wt.
Control		528.20±210.0 <sup>bc</sup>	90.3±26.1 <sup>c</sup>	275.0±56.4 <sup>c</sup>	44.6±11.8 <sup>d</sup>
Chitosan	0.5	72.7±72.7 <sup>a</sup>	16.7±16.7 <sup>a</sup>	0.00±0.00 <sup>a</sup>	0.00±0.00 <sup>a</sup>
	1	184.8±49.6 <sup>a</sup>	38.9±12.1 <sup>ab</sup>	109.5±57.5 <sup>ab</sup>	20.2±10.9 <sup>abc</sup>
	1.5	66.7±66.7 <sup>a</sup>	14.4±14.4 <sup>a</sup>	0.00±0.00 <sup>a</sup>	0.00±0.00 <sup>a</sup>
Salicylic acid	2.0	42.1±42.1 <sup>a</sup>	11.5±11.5 <sup>a</sup>	0.00±0.00 <sup>a</sup>	0.00±0.00 <sup>a</sup>
	0.5	158.2±54.0 <sup>a</sup>	28.2±5.43 <sup>ab</sup>	28.1±28.1 <sup>a</sup>	4.33±4.33 <sup>abc</sup>
	1	612.8±212.9 <sup>c</sup>	146.4±94.3 <sup>c</sup>	10.6±10.6 <sup>a</sup>	1.66±1.66 <sup>ab</sup>
	1.5	78.3±678.3 <sup>a</sup>	17.8±17.8 <sup>a</sup>	0.00±0.00 <sup>a</sup>	0.00±0.00 <sup>a</sup>
	2.0	78.9±78.9 <sup>a</sup>	19.9±19.9 <sup>a</sup>	7.33±7.33 <sup>a</sup>	1.00±1.00 <sup>a</sup>

#### Establishment of *in vitro* plantlets and callus cultures of 'sweetness *S. rebaudiana*'

*In vitro* cultures were established from nodal explants (Fig. 6). From these, leaves showing maximum sweetness index were selected as explants for callus induction and future production of high metabolite yielding cell line (Fig. 7).

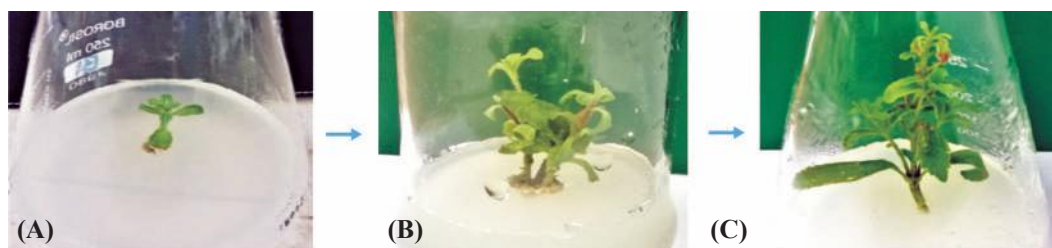

**Fig. 6** Micropropagation of sweetness stevia (A) inoculated explant, (B) after 2 weeks (C) after 3 weeks

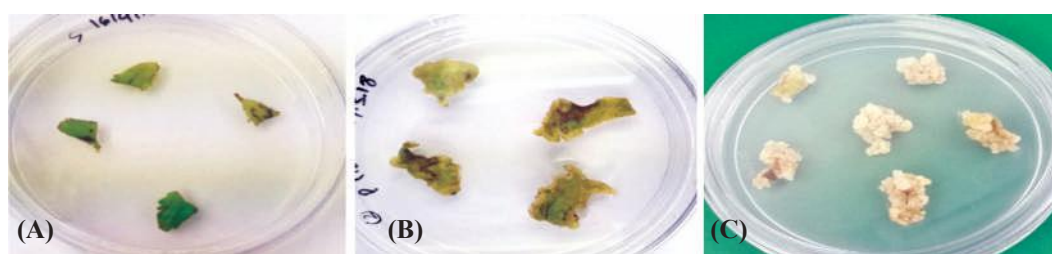

**Fig. 7** Establishment of callus culture in sweetness stevia: (A) inoculated leaf explant, (B) induction of callus after 2 weeks, (C) callus after 1 month from subculture.

### *Stevia (Stevia rebaudiana)*

#### Next generation genomic resources creation for genetic improvement

*Stevia* is a natural source of commercially important steviol glycosides (SGs) and share its biosynthesis route with gibberellic acids (GAs) through plastidal methylerythritol phosphate

(MEP) and cytosolic mevalonate (MVA) pathways. Higher synthesis and accumulation of SGs is reported to occur during vegetative or appearance of floral bud phase and this is followed by a decline in reproductive phase. Therefore, global transcriptome sequencing approach was adopted to understand the effect of metabolic shift in leaf tissues during developmental phase transitions on SGs biosynthesis. Leaves from 1<sup>st</sup> to 6<sup>th</sup> successive nodes of three phenotypically healthy plants were harvested in the mid of June (for vegetative phase: LV), in the mid of September (for bud phase: LB), and at the end of October (for flowering phase: LF) and 100 million reads were generated (Fig. 8).

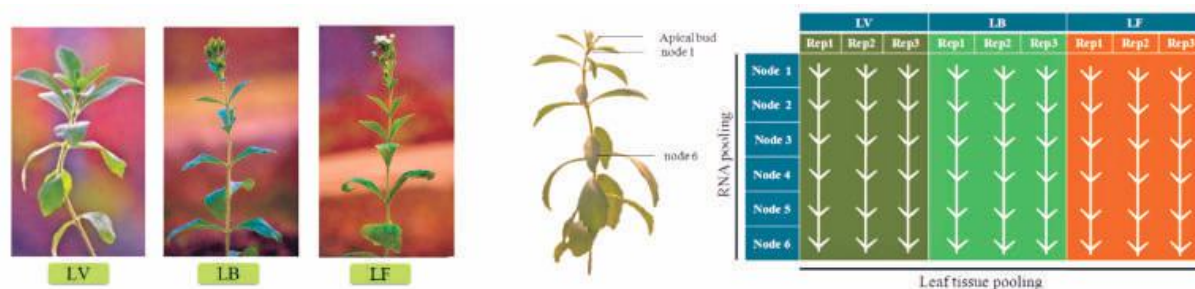

**Fig. 8** Schematic representation of methodology adopted for comparative leaf transcriptome analysis during developmental phase transition in vegetative (LV), budding (LB) and flowering (LF) tissues for dissecting ontogeny dependent SG biosynthesis in *S. rebaudiana*

Annotation of 41,262 *de novo* assembled transcripts with five main databases identified 29,436 (71.34 %), 28467 (70.0%), 23154 (56.11%) 8888 (21.54%) and 5683 (13.77%) annotations against NR, TAIR10, Swiss-Prot, PTF and KEGG databases, respectively (Fig. 9).

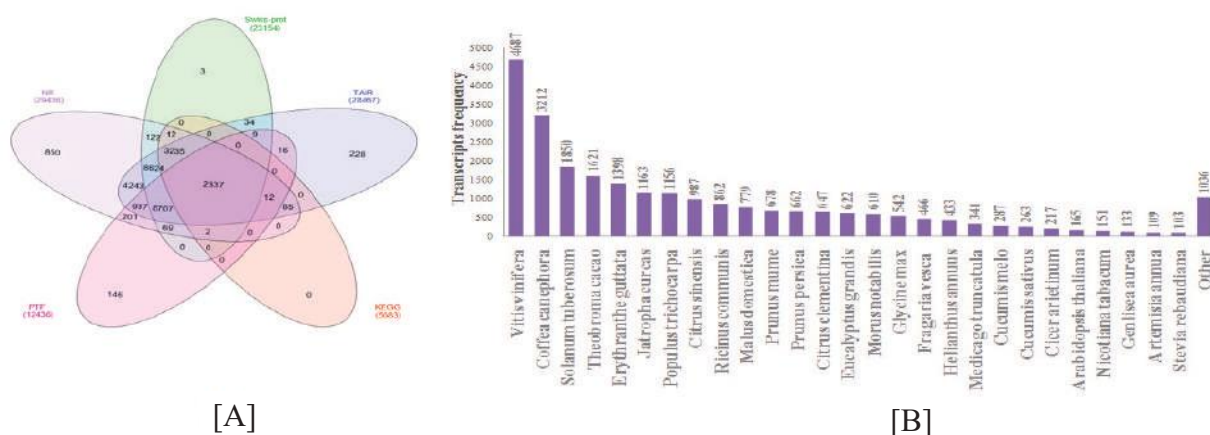

**Fig. 9** Functional annotation of *de novo* assembled transcripts (A) venn diagram representing the abundance of annotations with five different protein databases (B) histogram representing the species wise homology distribution in NR protein database annotations

Differential gene expression and quantitative analysis of important pathway genes (DXS, HMGR, KA13H) and gene regulators (WRKY, MYB, NAC TFs) indicated developmental phase dependent utilization of metabolic flux between SGs and GAs synthesis. Further, identification of 124 CYPs and 45 UGTs enriched the genomic resources. Putative candidates involved in

metabolic changes were identified in PPI network analysis of SGs/GAs biosynthesis proteins. All the genes required for SGs and GAs biosynthesis were identified in functional annotations. These putative targets are being utilized to expedite molecular breeding for selection of potential genotypes for SGs content, biomass and yield.

### Mining and characterization of microsatellite markers

Transcriptome as well as EST data available in public on stevia were utilized for marker identification. Survey of all the *de novo* assembled transcripts with MISA identified 3089 SSR containing sequences harbouring 3482 SSRs. The SSRs were classified as class I (repeat number  $\geq 20$  nucleotides) and class II (repeat numbers 12-19 nucleotides). Among different repeats, tri-repeats were most abundant (72.9%) followed by di-repeats (11.2%), hexa-repeats (6.5%), tetra-repeats (5.6%) and penta-repeats (3.7%). Variation in trinucleotide repeat leads to polymorphism with fewer chances of frame-shift mutation in essential genes. Among tri-repeats, (ATG/CAT)*n* type of repeat motifs coding for methionine/histidine were most predominant. Cluster analysis based on 247 alleles derived from 52 polymorphic primers were successfully tested for diversity characterization of 40 random *S. rebaudiana* genotypes and grouped in two major clusters (Fig. 10).

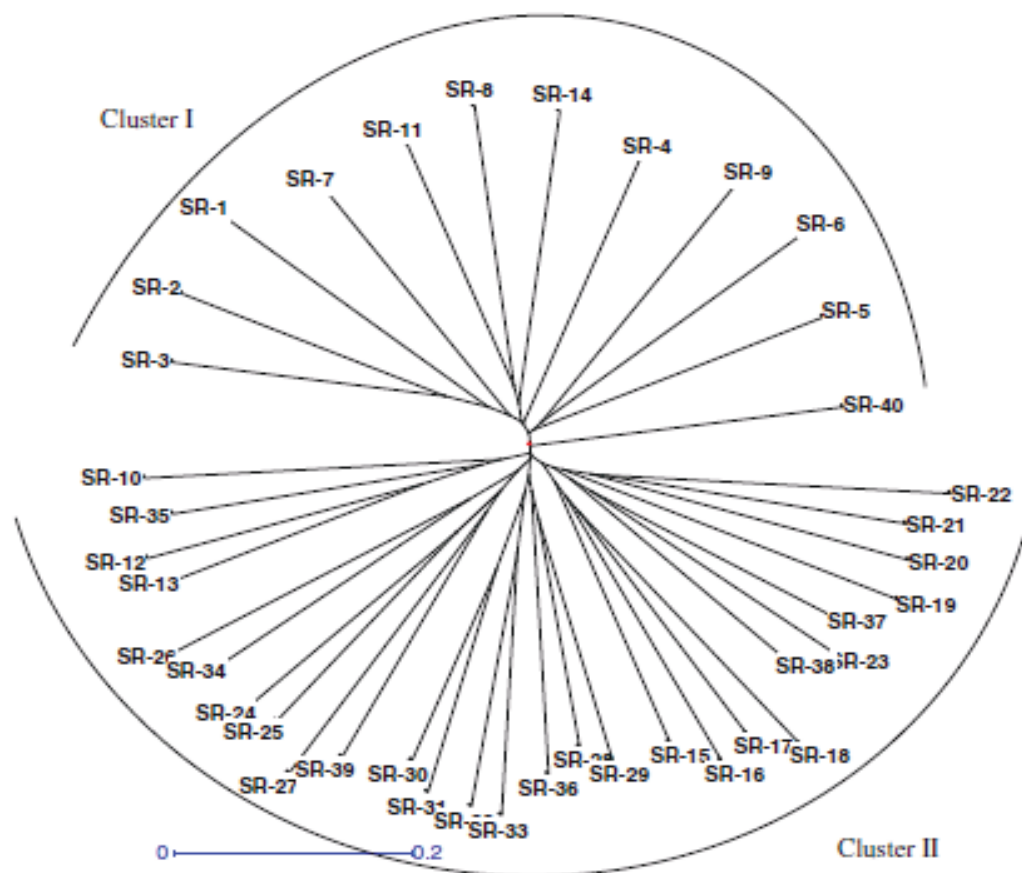

Fig. 10 Dendrogram showing genetic relationships among 40 random genotypes of *S. rebaudiana*

## Registration of Germplasm

Two stevia genotypes “Him Stevia CSIR-IHBT-ST-01” (INGR17052) and “Stevia mutant CSIR-IHBT-ST-02” (INGR15018) were registered as Germplasm at National Bureau of Plant Genetic Resources (NBPGR) by Plant Germplasm Registration Committee (PGRC) of Indian Council of Agricultural Research.

## FLORICULTURE

### Gerbera Breeding

Five hybrid F<sub>1</sub> selections of gerbera developed through controlled crossing program and multiplied through *in vitro* micro-propagation were morphologically characterized under protected cultivation with respect to floral traits (Table 4) and evaluated for field performance over a period of four years. Plantation was done in Randomized Block Design with fifteen plants per genotype replicated four times. Data recording was done on five plants per replication for flower diameter (cm), stalk length (cm) and number of flowers per plant over a period of four years from 2014-15 to 2017-18. Data over the four years was pooled to work out the analysis of variance for the field performance of selected and parental genotypes. Two peaks of flowering season were observed during each year, first during March-April and second during September-October. Based on mean performance of hybrid gerbera genotypes over four replicates yearly variations were recorded in the gerbera selections (Fig. 11). IHBT-Gr-11-6, 13-1, 29-1 and Y-1 were superior with respect to stalk length (cm), while IHBT-Gr-24-6 had dwarf stalk length (< 30cm). Flower size of IHBT-Gr-11-6 was mini, while other lines had standard flower size (> 10 cm flower diameter). IHBT-Gr-24-6 was superior for number of flowers per plant in a year in comparison to other lines (Table 5).

**Table 4** Details of floral features of new gerbera F<sub>1</sub> selections

S. No.	Plant No.	Flower colour	Flower shape	Disc colour	Flower type
1.	IHBT-Gr-11-6	Light Yellow	Semi-Double	Green	Mini
2.	IHBT-Gr-13-1	Red Purple	Double	Green	Standard
3.	IHBT-Gr-24-6	Yellow orange	Semi-double	Brown	Standard
4.	IHBT-Gr-29-1	Red	Semi-double	Green	Standard
5.	IHBT-Gr-Y-1	Yellow	Semi-double	Green	Standard



**Fig. 11** Potential gerbera genotypes with high *in vitro* proliferation (left to right: IHBT-Gr-11-6, 13-1, 24-6, 29-1 & Y-1)

**Table 5** Field performance of new gerbera F<sub>1</sub> selections

Traits	Selections	Year			
		2014-15	2015-16	2016-17	2017-18
Flower size (diameter in cm)	IHBT-Gr-11-6	10.20	9.37	9.72	9.30
	IHBT-Gr-13-1	10.50	10.27	10.15	10.25
	IHBT-Gr-24-6	11.70	10.71	10.50	10.47
	IHBT-Gr-29-1	10.50	10.15	10.02	10.45
	IHBT-Gr-Y-1	11.50	10.55	10.42	10.87
Stalk length (cm)	IHBT-Gr-11-6	43.00	41.35	41.60	42.30
	IHBT-Gr-13-1	46.50	43.60	44.00	43.60
	IHBT-Gr-24-6	29.60	29.10	29.25	29.60
	IHBT-Gr-29-1	45.75	44.80	45.90	44.95
	IHBT-Gr-Y-1	44.50	44.20	44.75	45.55
Number of flowers per plant	IHBT-Gr-11-6	18.80	17.40	17.65	17.30
	IHBT-Gr-13-1	24.40	21.85	21.55	21.75
	IHBT-Gr-24-6	25.50	23.05	23.25	23.70
	IHBT-Gr-29-1	23.30	22.10	21.95	21.85
	IHBT-Gr-Y-1	20.00	19.10	18.75	18.30

Analysis of variance for the field performance parameters indicate significant variations for flower number per plant, stalk length (cm) and flower size (diameter in cm) among the five selected hybrids and their five parental lines (Table 6).

**Table 6** ANOVA test for the differences in flower number per plant, stalk length (cm) and flower size (diameter in cm) among ten genotypes of gerbera

Source of variation	Variance	F- value
Flower number per plant	66.07	252.51*
Stalk length (cm)	188.98	1278.81*
Flower size (diameter in cm)	3.36	127.48*

\*Significant at P = 0.05

## Calla lily Breeding

### Selection and evaluation of potential Calla lily genotypes

Two hybrid F<sub>1</sub> selections CSIR-IHBT-CL-Y-1 of calla lily (*Zantedeschia elliottiana*) and CSIR-IHBT-CL-W-1 of *Zantedeschia aethiopica* developed through controlled crossing program at CSIR-Institute of Himalayan Bioresource Technology, were characterized morphologically with respect to floral traits and evaluated for field performance over a period of four years from 2014-15 to 2017-18. These selections were evaluated along with parents in Randomized Block Design replicated four times with respect to floral traits and other agronomic attributes.

Based on mean performance of calla lily (*Zantedeschia elliottiana*) genotypes evaluated over four years, selection CSIR-IHBT-CL-Y-1 was superior with respect to flower stalk length and

number of flowers/plant with attractive bright yellow colour and trumpet shaped flowers among the other genotypes (Fig. 12, Table 7).



Fig. 12 Flower and field view of calla lily (*Zantedeschia Elliottiana*) under field evaluation trial

Table 7 Field performance of calla lily (*Zantedeschia Elliottiana*) genotype CSIR-IHBT-CL-Y-1

Morphological Traits	Years				Mean
	2014-15	2015-16	2016-17	2017-18	
<b>Flower traits</b>					
Number of flowers/plant	3.2	2.8	2.9	3.1	3.0
Flower stalk length (cm)	58.4	59.7	56.2	60.4	58.7
Flower stalk diameter (mm)	15.2	16.2	15.7	16.4	15.9
<b>Agronomic traits</b>					
Plant height (cm)	78.5	86.8	84.3	79.5	82.3
Leaf length (cm)	21.4	24.5	22.2	23.5	22.9
Leaf width (cm)	11.3	14.2	12.1	13.1	12.7

Whereas, the genotype CSIR-IHBT-CL-W-1 of calla lily *Zantedeschia aethiopica* was superior with respect to flower stalk length, flower stalk diameter and number of flowers/plant with white colour among the other genotypes (Fig. 13, Table 8).



Fig. 13 Flower and field view of calla lily (*Zantedeschia aethiopica*) under field evaluation trial



**Table 8** Field performance of calla lily (*Zantedeschia aethiopica*) genotype CSIR-IHBT-CL-W-1

Morphological traits	Years				Mean
	2014-15	2015-16	2016-17	2017-18	
<b>Flower traits</b>					
Number of flowers/plant	5.0	6.7	7.1	8.3	6.775
Flower stalk length (cm)	87.5	85.3	86.3	89.1	87.05
Flower stalk diameter (mm)	18.7	19.2	18.4	19.3	18.9
<b>Agronomic traits</b>					
Plant height (cm)	85.6	82.2	84.1	84.6	84.125
Leaf length (cm)	35.5	32.7	34.7	33.3	34.05
Leaf width (cm)	19.5	15.4	17.5	16	17.1

#### Comparative studies on growth and flowering of tulips in hydroponics and open field conditions

In the present study, tulip varieties ‘Barcala’ and ‘Verjihi’ were grown in two growing conditions i.e. hydroponics and open field conditions (Fig. 14) during January-February, 2018. During the growth and flowering phase, the temperature in hydroponic system was around  $20\pm 2^{\circ}\text{C}$ , relative humidity ( $65\pm 5\%$ ) and photoperiod of 16/8 hours, whereas, in open field conditions, the temperature was around  $18\pm 2^{\circ}\text{C}$ , relative humidity ( $40\pm 5\%$ ) and photoperiod 11/13 hours. Hydroponic cultivation w.r.t. open field cultivation showed good growth and flowering.



10 days growth



25 days growth

**Fig. 14** Tulip varieties in hydroponic system

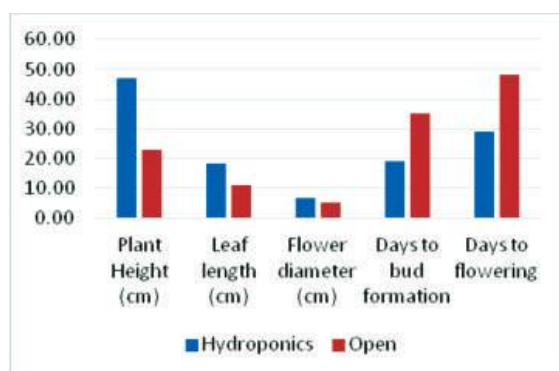

Fig. 15 Effect of growing conditions on growth and flowering

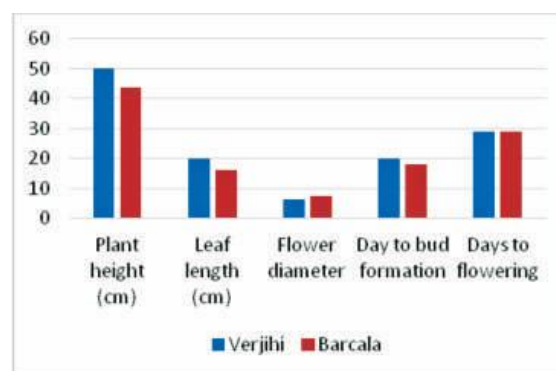

Fig. 16 Performance of tulip variety 'Verjihi' and 'Barcala' in hydroponics system

The effect of growing conditions on various growth parameters of tulips such as plant height, leaf length, flower diameter, days to bud formation and days to flowering were studied during growth and flowering. Plants grown hydroponically (Fig. 15) were taller (46.90 cm) with large leaf length (17.96 cm), more flower diameter (6.77) and early days to bud formation and flowering (19 and 29 days) as compared to plants grown under open conditions (22.83 cm, 10.77 cm, 5.18 cm, 35 and 48 days respectively). Among varieties, hydroponics grown tulip variety 'Verjihi' (Fig. 16) recorded maximum plant height (50.05 cm), leaf length (19.94 cm) and flower diameter (6.15) as compared to variety 'Barcala' (4.75 cm, 15.97 cm, 7.39 cm respectively), whereas, 'Barcala' showed early days to bud formation (18 days) w.r.t. 'Verjihi' i.e. 20 days.

### Collection and evaluation of Cymbidium varieties of orchids

In addition to twelve varieties of cymbidium germplasm collection six accessions of five year old plants were added in germplasm from Darjeeling and planted in 2:1 ratio of coco-peat and coco-chips substrates and maintained in 50% black shade net conditions at experimental farm. Morphological parameters were recorded for all six accessions and presented in Table 9 and Fig. 17.

Table 9 Morphological characteristics of different accessions of cymbidium orchids

Cymbidium accession No.	No. of spikes/ plant	Length of spike (cm)	No. of florets/ spike	Diameter of flower (cm)	No. of pseudo-bulbs/ plant
DG 1002	2.50	40.51	10.08	4.42	4.74
DG 1024	2.40	37.46	4.84	5.88	5.58
DG 1051	1.40	63.30	7.30	8.80	7.70
DG 1054	2.34	41.45	5.28	7.73	7.22
DG 1023	1.29	52.43	8.43	7.13	8.14
DG 1078	1.00	92.00	3.00	6.50	12.00

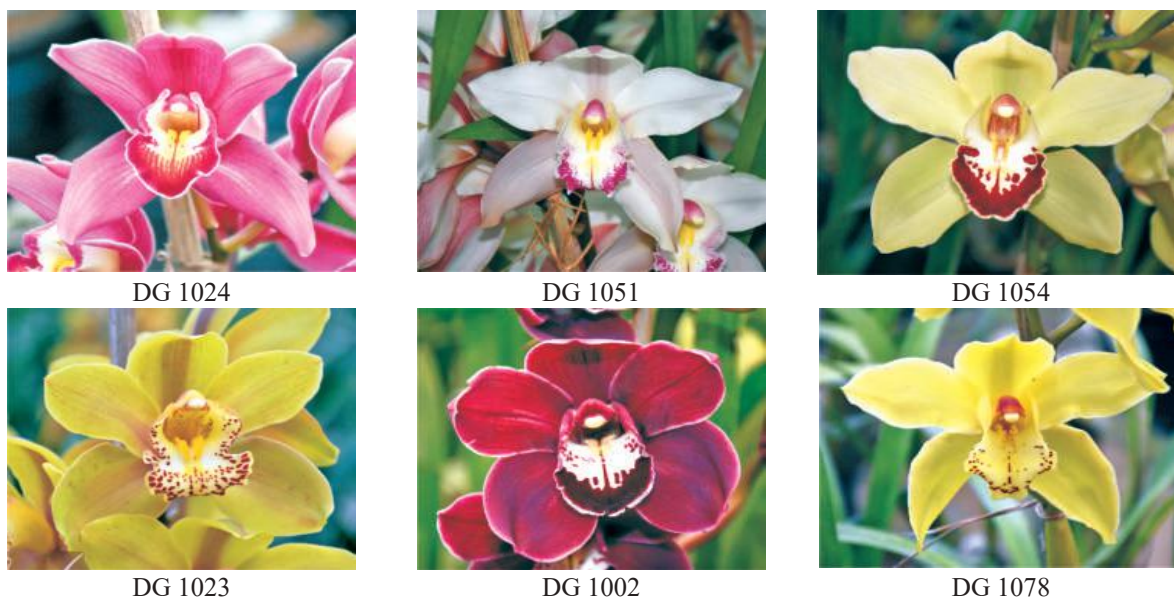

Fig. 17 Collection of Cymbidium orchids accessions

### Indoor Air Pollution Abatement

In the present study, the real time readings of Volatile Organic Compounds (VOCs) and CO<sub>2</sub> in morning and evening hours upon keeping three potted plants of areca palm (*Dypsis lutescens*) were recorded at two different sites i.e. canteen and library of our institute. Real time readings of VOCs in two sites of IHBT were recorded with Q-TRAK Indoor Air Quality Monitor (Model 7575, TSI Corp.). Data showed the effect of keeping areca palm plants at canteen site during morning hours (Fig. 18), VOCs were reduced from 0.79 ppm to 0.31 ppm in 30 days' interval at canteen (60% reduction in VOCs level), whereas it reduced from 0.22 ppm to 0.12 ppm in 30 days' interval at library (45% reduction in VOCs level). In evening hours (Fig. 19), VOCs was reduced from 0.40 ppm to 0.26 ppm in 30 days' interval at canteen which was 35% reduction in VOCs level, whereas, it was reduced from 0.17 ppm to 0.12 ppm in 30 days' interval at library which was 30% reduction in VOCs level.

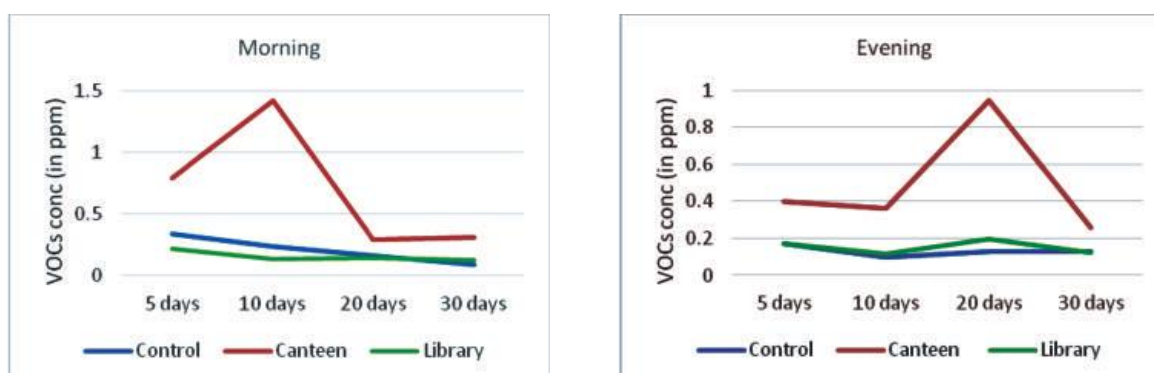

Fig. 18 & 19 Real time measurement of VOCs concentration (in ppm) at different site keeping 3 plants of areca palm/ site

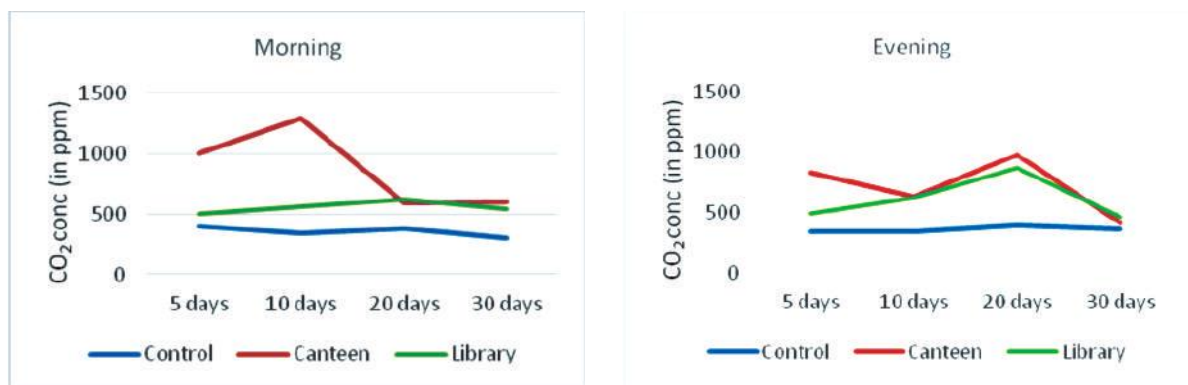

Fig. 20 & 21 Real time measurement of CO<sub>2</sub> concentration (in ppm) at different site upon with keeping 3 plants of areca palm/ site

Reduction in CO<sub>2</sub> levels were also observed in both sites. In canteen during morning hours (Fig. 20), it was reduced from 999 ppm to 599 ppm in 30 days interval which was 40% reduction in CO<sub>2</sub> level, whereas, it increased from 502 ppm to 540 ppm in 30 days interval at library which was 8% increase in CO<sub>2</sub> level. In evening hours (Fig. 21), CO<sub>2</sub> reduced from 831 ppm to 421 ppm in 30 days interval at canteen which was 49% reduction in CO<sub>2</sub> level, whereas, it reduced from 502 ppm to 468 ppm in 30 days interval at library which was 7% reduction in CO<sub>2</sub> level.

#### Effect of different substrates on seed germination of *Zantedeschia aethiopica* var 'Him Shweta'

Experiment was conducted to observe the germination percentage of calla lily seeds in different combination of substrates. Four substrates i.e. sand, soil, coco-peat and FYM were used in fifteen different combinations.

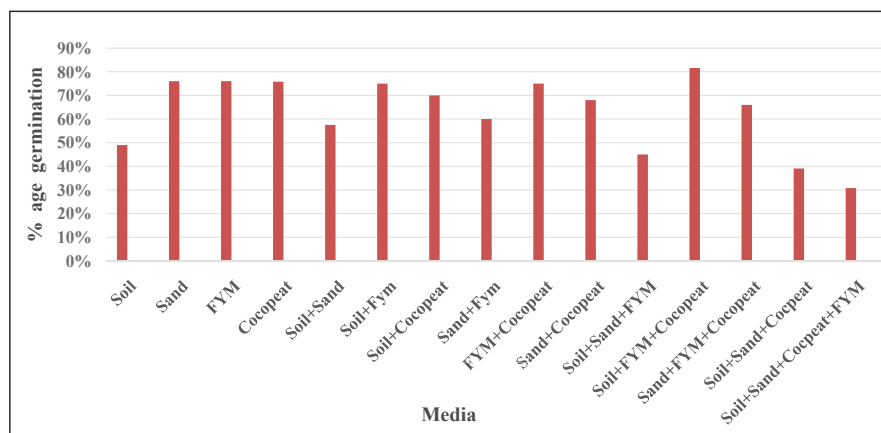

Fig. 22 Effect of different substrates on seed germination percentage of calla lily

A total of 120 Calla lily seeds were sown in each treatment. It was found that the combination soil + FYM + coco-peat showed highest germination i.e. 82% followed by sand, FYM and coco-peat i.e. 76%. The lowest percentage of germination was recorded in combination of soil + sand + coco-peat + FYM (31%) followed by 39% in combination of soil + sand + coco-peat (Fig. 22).



Soil + FYM + Coco-peat    Soil + Sand + Coco-peat    Soil + Sand + FYM + Coco-peat    Sand + Coco-peat

**Fig. 23 Effect of different substrates on seedling growth of calla lily**

Among the different media, the maximum seedling length (14.84cm), leaf length (7.17cm), number of leaves (5.67) and root length (15.50 cm) were observed with coco-peat + FYM treatment as compared to other media. Leaf width (3.34 cm) was found maximum in coco-peat + FYM + soil media (Fig. 23).

**Comparative studies on growth and flowering of liliun varieties in polyhouse, shade net, and open field conditions.**

In this study, liliun varieties ‘Brunello’, ‘Bach’, ‘Menorca’ and ‘Tresor’ were grown in three growing conditions i.e. poly house, shade net (50%) and in open field conditions. During growth and flowering, the average temperature and relative humidity in poly house was around 21±4°C and 55±5%. In shade net conditions, the temperature and humidity was around 16±2°C and 50±5%, whereas, in open field conditions the temperature and humidity was around 18±2°C and 40±5%.

Among three different conditions (Fig. 24), open field conditions showed 3 and 21 days early bud formation as compared to polyhouse and shade net conditions respectively, whereas, polyhouse conditions showed 18 days early bud formation as compared to shade net conditions. Days to flowering were almost same in open field and polyhouse conditions and 15 days earlier in flowering as compared to shade net conditions (Fig. 25).

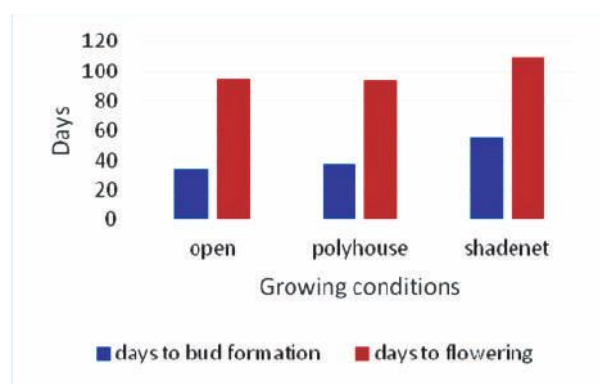

**Fig. 24 Effect of growing conditions on days to bud formation and flowering**

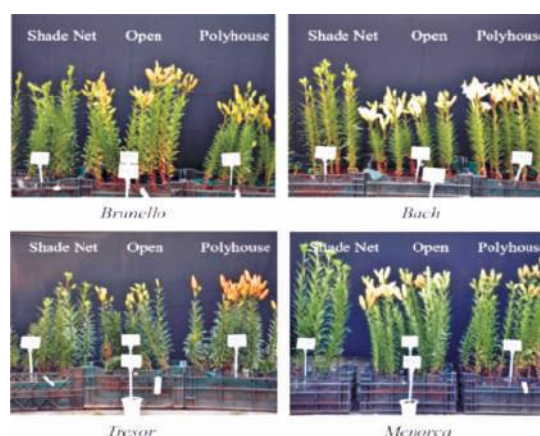

**Fig. 25 Effect of growing conditions on growth of liliun varieties Brunello, Bach, Tresor and Menorca**

### Effect of GA<sub>3</sub> spray on flowering of Calla Lily (*Zantedeschia aethiopica* var 'Him Shweta')

Experiment was conducted to achieve good quality flower spikes of *Zantedeschia aethiopica* var. 'Him Shweta' through spray of different concentrations of gibberellins. Gibberellins initiate early flowering in many ornamental plants and increase the number of flowers. In this experiment, four different concentrations of GA<sub>3</sub> i.e. 25 ppm, 50 ppm, 100 ppm and 200 ppm were sprayed on six month old Calla lily plants. GA<sub>3</sub> was sprayed for three durations i.e. S1 (one time), S2 (two times) and S3 (three times) at interval of 11 days. The tallest spike (56.20 cm) was recorded with T1S3 i.e. three sprays of GA<sub>3</sub> (25 ppm) compared to control (47.02 cm). More number of leaves and as shoots per plant was recorded i.e. 18 and 8.80, respectively as compared to control (16 and 7.74). Three spikes per plant were observed with two and three sprays of GA<sub>3</sub> (25 ppm), whereas, 2.40 spikes/ plant were recorded with control.

## TEA

### Growth and developmental process of tea leaf through proteomic approach

Previously, the gene expression profiles associated with changes in leaf color during the developmental stages of tea leaves were investigated and differentially expressed genes were identified. However, identification of differentially expressed genes at mRNA level is not sufficient for the prediction of protein expression levels and the changes in metabolites during leaf development (Fig. 26). Scanning electron microscopy revealed clear morphological differences between the leaves. Proteomic techniques like 2D SDS-PAGE, coupled with MALDI-ToF/ToF and revealed a total of 81 non-redundant proteins Representative 2DE gel picture are shown in Fig. 29.

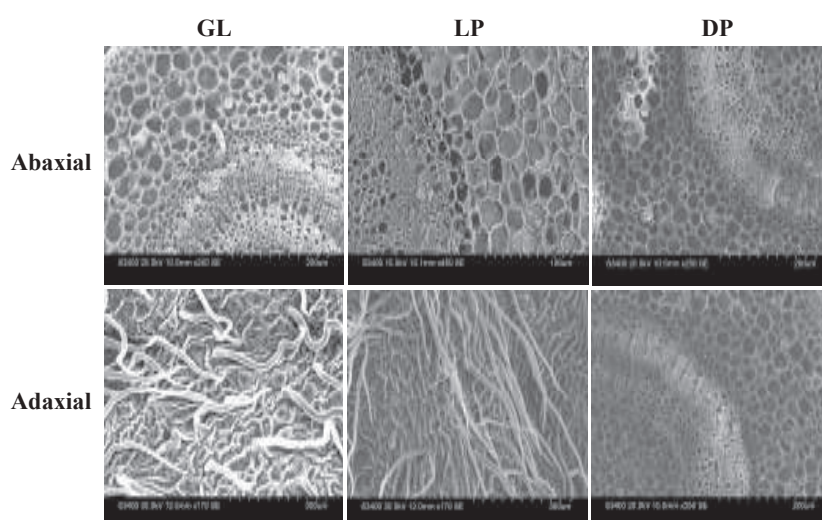

Fig. 26 Electron microscopic image of abaxial and adaxial surface of green leaf (GL), light purple (LP) and dark purple (DP) leaves showing number of stomata, texture and glandular tissue

Functional classification of the identified proteins suggested metabolic and cellular processes as predominated functions in leaf tissue (Fig. 27). Principal component analysis (PCA) was performed on normalized protein spot intensities for all identified proteins in a reduced-components space defined by the principal components (PCs) (Fig. 28).

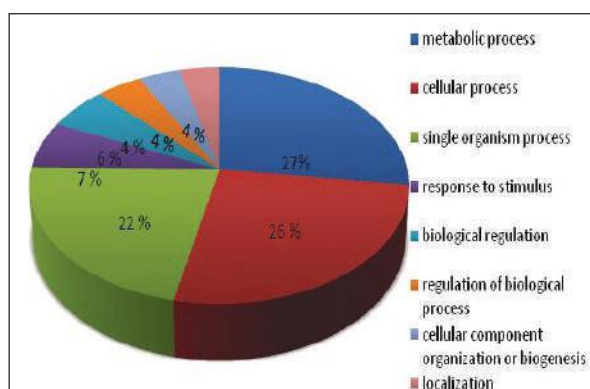

Fig. 27 Biological Functions of identified proteins using Blast 2 GO

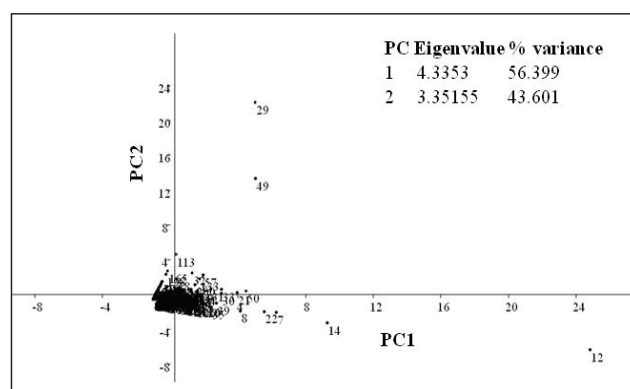

Fig. 28 PCA analysis of identified proteins using MeV software

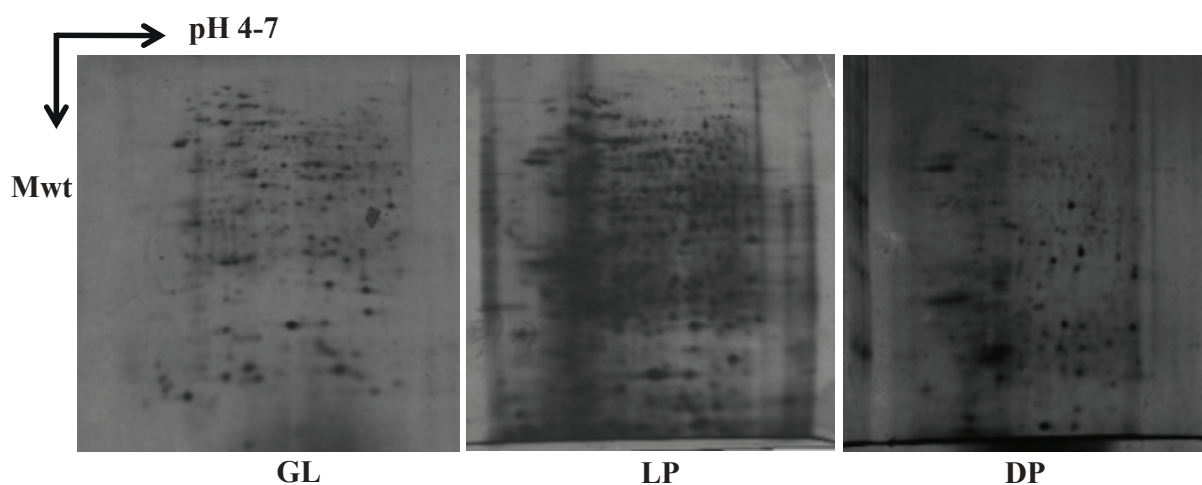

Fig. 29 Proteome profile from representative 2-DE gels of GL, LP and DP. The proteins were isolated from leaves and resolved by classical 2-DE using IPG strips pH 4-7, 11 cm

PC1 and PC2 accounted for 56.399 and 43.601% of the total data variance in protein expressions, respectively. qRT-PCR of eight identified proteins involved in different metabolic pathways revealed five proteins with similar expression pattern and transcript accumulation. However, three deviated in their protein and transcript expression. This difference in transcript accumulation and protein expression could be due to presence of multi-gene family and different post transcriptional/translational modifications.

### Characterization of $F_1$ progenies for disease resistance, quality and productivity

In continuation to previous work, a biclonal population was developed through hybridization of SA-06 known as source of blister blight resistance caused by *Exobasidium vexans* and Kangra Asha which is good in quality but susceptible to the diseases 254  $F_1$  progenies thus obtained were planted and scored in field for disease incidence. Disease severity was studied by using grid method on the basis of 0-6 scale under field conditions (Fig. 30).



**Fig. 30** Biclinal  $F_1$  population developed through hybridization program; 0-6 scale and grid method used to evaluate disease severity

Finally, based on disease severity reactions under field conditions, biclinal population was categorized into six phenotypic groups (Fig. 31).

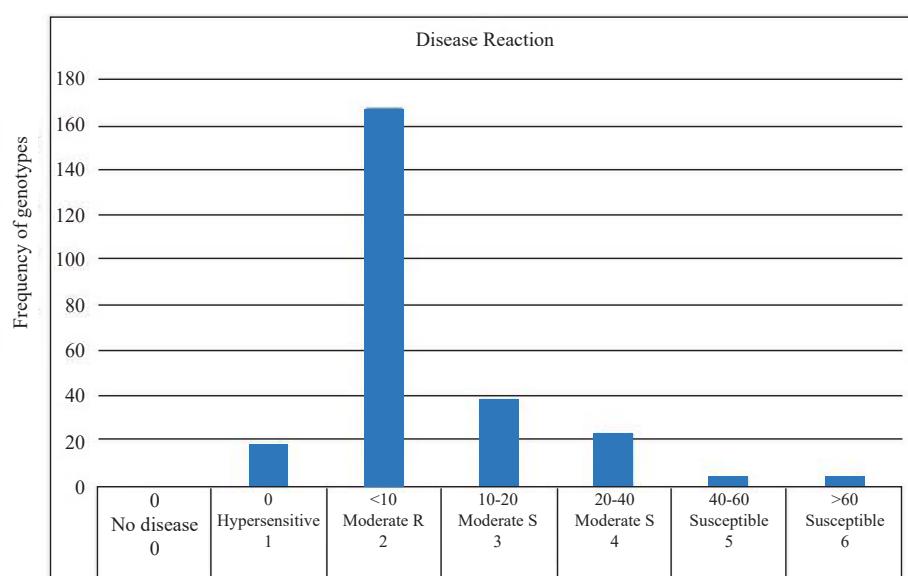

**Fig. 31** Graph depicting disease severity (%) reaction of SA-6 x Kangra Asha progenies under field conditions

The resistant  $F_1$  progenies were morphologically characterized with respect to plant height (cm), number of shoots, shoot length (cm), leaf length (cm), leaf width (cm), internode length (cm) and plant spread diameter (m). Thirteen promising resistant genotypes were propagated during the previous year under nursery conditions (Table 10). Currently, the genotypes have been planted under field condition in replicated trial for evaluation of productivity and quality so as to select disease resistant quality clones having high productivity (Fig. 32).



**Table 10 Morphological characterization of promising disease resistant F<sub>1</sub> progenies of cross SA-6 x Kangra Asha**

Genotype	Plant Height (m)	No. of Shoots	Shoot Length (cm)	Length of Internode (cm)	Leaf Length (cm)	Leaf Width (cm)	Plant Spread diameter (m)
03-10	1.7	21	138	5.5	16	6.4	1.16
03-6	1.91	28	140	4.4	12.4	5.8	1.23
03-44	1.61	21	118	4.8	12.5	5	1.11
03-1	1.95	18	118	5.5	15.5	5.1	1.31
03-69	2.06	25	118	4.8	13.3	4.7	1.21
03-108	1.85	17	122	4.3	12.9	5.8	1.34
03-37	1.91	25	139	4.4	12.6	6.6	1.45
03-55	1.68	23	160	4.4	10.4	4.3	1.17
03-101	2.07	18	114	5.5	15.2	4.8	1
03-91	1.59	14	115	3.9	9.7	3.8	1.06
03-104	1.74	13	139	5.8	15	5	1.16
02-24	1.93	17	138	4.2	13.7	4.1	1
03-70	2.11	18	166	4.6	11	4.4	1.35

**Fig. 32 Plantation of selections in replicated trial for evaluation under field conditions**

### Mechanization of tea farm operations

A study was conducted to study the impacts of mechanical harvesting on the production and quality of tea. Trials were laid out separately in china hybrid tea and Tukdah 78 clonal tea sections at Tea Experimental Farm, Banuri to assess the four plucking method viz., one man plucking machine, two men plucking machine, hand shear and hand plucking (Fig.33). These methods were employed in association with three fertilizer levels of nitrogen, phosphorus and potash i.e. F1 (90:90:90 N:P<sub>2</sub>O<sub>5</sub>:K<sub>2</sub>O kg/ha), F2 (120:90:120

N:P<sub>2</sub>O<sub>5</sub>:K<sub>2</sub>O kg/ha) and F3 (180:90:180 N:P<sub>2</sub>O<sub>5</sub>:K<sub>2</sub>O kg/ha) to study the plucking effect on green leaf yield and fineness of the harvest in china hybrid tea. Hand plucking method was considered as control for the study. The tea leaf yield was recorded in each harvest during the season. For the evaluation of quality parameters, samples were drawn from the harvested crop from each respective plot. Green tea and orthodox black tea was also made from the samples. Total polyphenols, catechins and flavonoids were estimated by spectrophotometric method. Plant physiological parameters viz., net photosynthetic rates and stomatal conductance to water vapour were recorded by using LI-6400 photosynthesis system (Li-COR, Lincoln, USA) in the field.

The results showed (Fig. 34) that across the different fertilizer doses, the mechanical methods of plucking had significant higher yield than hand plucking. Across different methods of plucking, the fertilizer level 120:90:120 (F2) showed higher yield than other combinations. Leaf grade or fineness of leaf was noticeably reduced with all mechanical methods (Fig. 35). However, the reduction was relatively less with hand shears. Mechanized shear harvester enhanced the working capacity of individual labourer and could be used for selective plucking.

However, there was a gradual decline in the total polyphenolic content in the one man and two men plucking methods. A drop in the total catechin content was also observed in one man and two men plucking methods compared with hand plucking. Similar trend was observed for the total flavonoid content i.e. a decline with the shear plucking, one man and two men plucking methods as compared to hand plucking. In the case of photosynthetic rate and stomatal conductance, there was a decrease in the photosynthetic rate in the tea bushes plucked with any of the mechanical methods i.e. shear, one man plucking and two men plucking machines in comparison to hand plucking. Similar trend was observed in case of stomatal conductance. There was a general reduction in stomatal conductance of tea bushes in all the mechanical methods in comparison to manual plucking.

In order to sort out cut leaves and undesirable cut fractions of foliage and stems etc, a continuous type green leaf shoot sorter was designed, fabricated and installed at the Institute's tea experimental farm. A shed was constructed to house this leaf sorter.



**Fig. 33 Different methods of plucking**

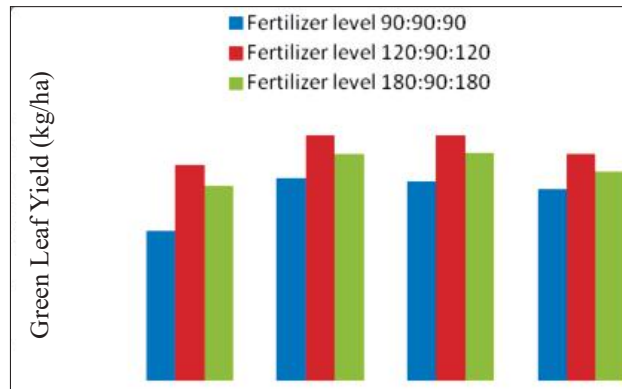

Fig. 34 Effect of plucking methods and fertilizer level on green leaf yield

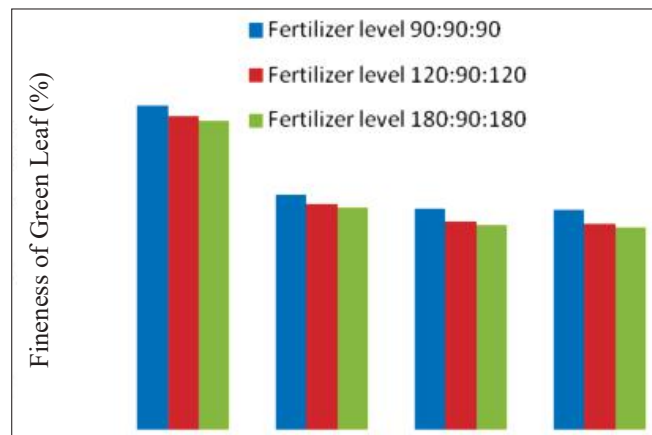

Fig. 35 Effect of plucking methods and fertilizer level on fineness of the harvested leaf

### GREEN TEA LEAF SHOOT SORTER

An improved low cost green tea leaf shoot sorter was partially installed in the Banuri tea garden of the Institute (Fig. 36).

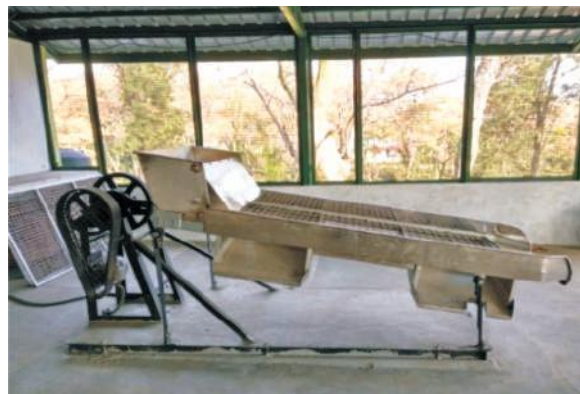

Fig. 36 Tea leaf sorter

### Selection of Purple tea genotypes

Sixteen selections were made for anthocyanin rich tea (Fig. 37) and these purple tea genotypes were morphologically characterized with respect to plant height (m), no. of shoots, shoot length (cm), leaf length (cm), leaf width (cm), internode length (cm) and plant spread diameter (m) (Table 11). Cuttings of purple tea were raised (up to seven hundred) under nursery condition for preliminary yield trials.



Fig. 37 (A) Purple tea germplasm at Banuri farm (B) purple tea leaves rich in anthocyanin pigment

Table 11 Morphological characters of purple tea genotypes

Genotype	Plant height (m)	No. of shoots	Shoot length (cm)	Length of internode (cm)	Leaf length (cm)	Leaf width (cm)	Plant spread diameter (m)
PT-1	1.83	18	148	4.8	10.7	5.0	1.27
PT-2	1.56	14	134	4.4	14.0	6.0	1.18
PT-3	2	21	160	5.2	14.8	6.2	1.26
PT-4	1.79	16	142	4.8	11.7	5.2	1.11
PT-5	1.68	15	151	4.8	15.0	6.8	1.28
PT-6	2.09	18	168	5.2	14.3	6.6	1.30
PT-7	1.11	11	126	4.4	10.8	5.4	1.15
PT-8	2.06	14	161	5.8	13.8	6.2	1.31
PT-9	2	18	160	5.0	16.0	7.2	1.26
PT-10	1.28	12	131	4.5	15.4	6.2	1.18
PT-11	1.67	15	147	4.6	16.0	7.3	1.22
PT-12	1.35	13	130	4.5	15.0	6.2	1.17
PT-13	1.68	16	148	4.8	13.8	5.5	1.15
PT-14	1.22	11	132	4.5	14.0	5.7	1.0
PT-15	1.57	17	150	4.6	11.7	5.0	1.21
PT-16	1.82	17	152	5.0	15.0	5.5	1.26
PT-17	1.68	20	157	4.7	14.7	4.8	1.17

## Tea Chemistry

### L-Theanine

Tea constitutes a non-protein amino acid L-theanine responsible for the relaxing effect of tea and contributes to its umami taste. Tea rich in L-theanine is ranked higher in taste, quality and price in international market. Biotransformation using gamma-glutamyl transferase (GGT) (E.C.2.2.3.2), an evolutionary conserved enzyme, specifically catalyzes the cleavage of  $\gamma$ -glutamyl bond and transfers  $\gamma$ -glutamyl group to amino acids or peptides (transpeptidation). Response surface methodology was used for optimization of growth conditions and medium composition to enhance enzyme activity as well as its bio mass production (Fig. 38).

Culture conditions namely pH, temperature, carbon and nitrogen sources for growth as well as GGT production by microorganism was optimized using one-variable at a time (OVAT) approach.

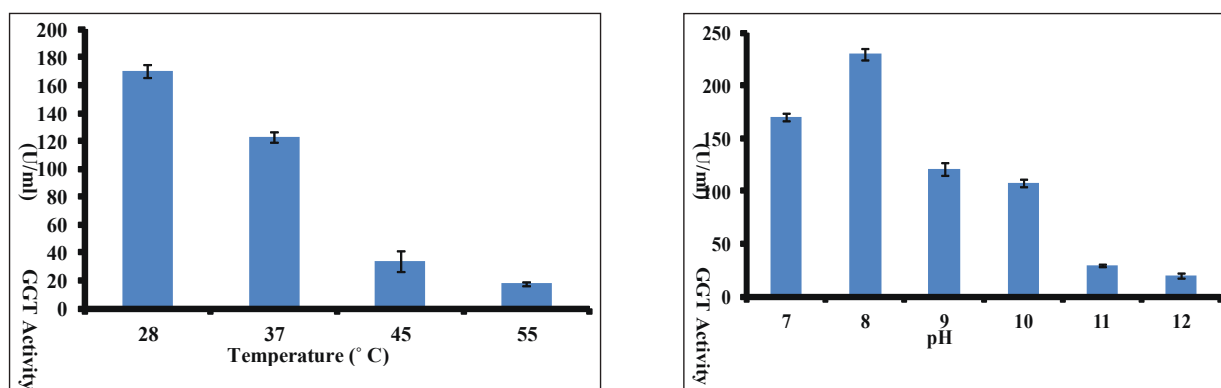

Fig. 38 Temperature and pH optimization experiment for GGT production using OVAT approach

Temperature (28 °C), pH 7.0, glucose and yeast extract were important for growth as well as enzyme production (Fig. 39).

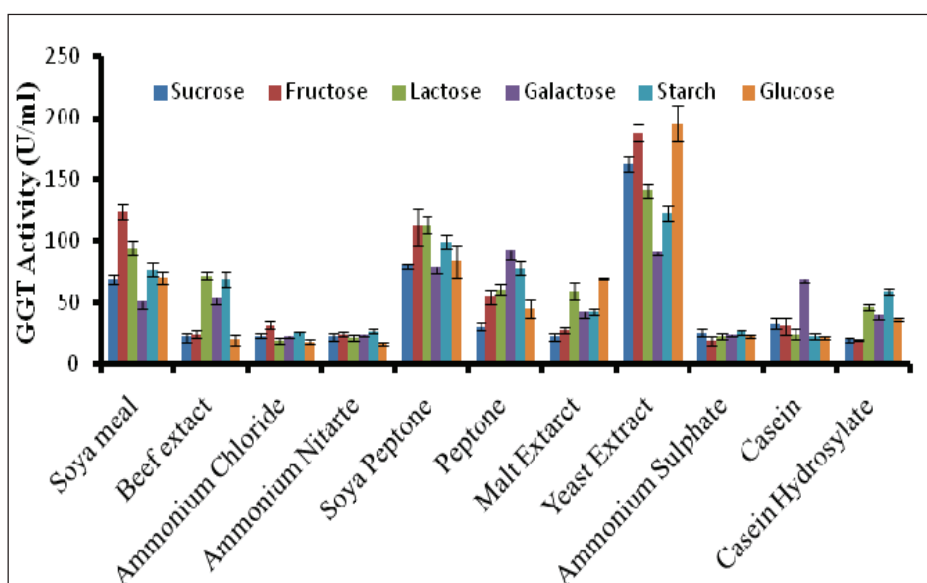

Fig. 39 Optimization of carbon-nitrogen source for enzyme production

## Anthocyanins

In continuation to previous work on extraction, purification and characterization of anthocyanins from purple tea shoots, eight anthocyanins belonging to cyanidin, delphinidin, petunidin, peonidin and malvidin group were purified by chromatographic methods and characterized using spectroscopic techniques. Major anthocyanin present in tea is cyanidin-3-glucoside. The anthocyanins have potential use in cosmetic and nutraceutical industries (Fig. 40).

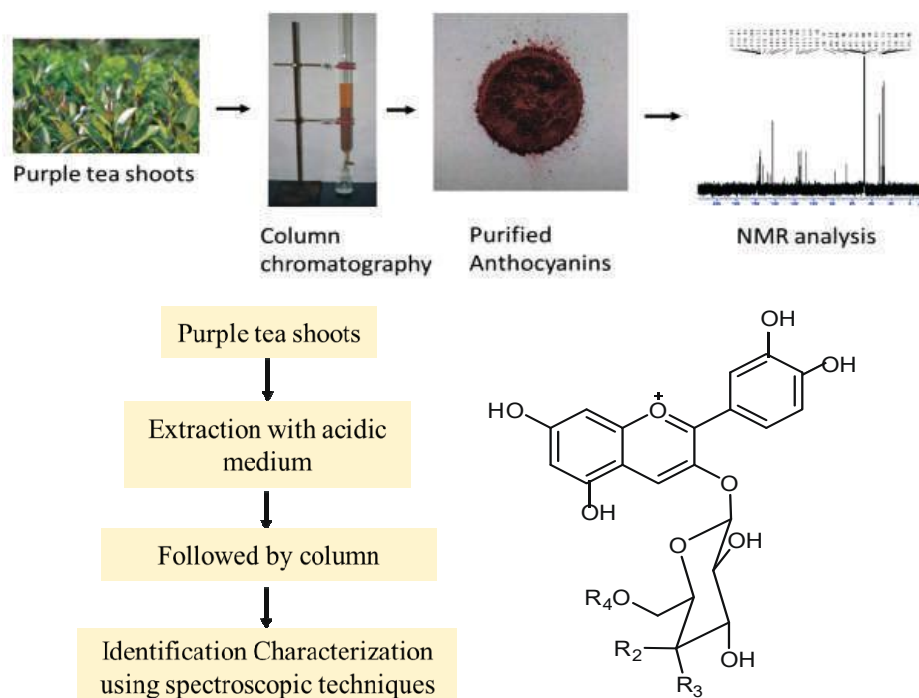

Fig. 40 Major tea anthocyanin: Cyanidin-3-glucoside

## Extraction, isolation and identification of EGCG from Kangra tea shoots

Aqueous extract of fresh tea shoots was passed through resin column to obtain a catechin enriched fraction. Concentrated fraction was then passed through silica and RP-18 column to get pure EGCG. Structural confirmation of the isolated EGCG was carried out by NMR spectroscopy and ESI-LC-MS analysis. The isolated EGCG was quantified by UPLC and recorded a purity of 94.58% (Fig. 41 & 42).

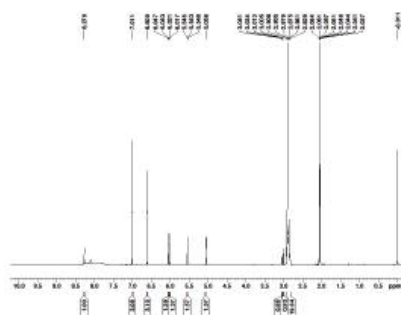

Fig. 41 <sup>13</sup>C NMR spectra of EGCG

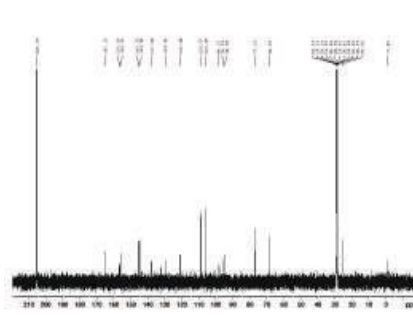

Fig. 42 <sup>1</sup>H NMR spectra of EGCG

## BAMBOO

Nurseries of important bamboo species such as *Dendrocalamus hamiltonii*, *Phyllostachys pubescence*, *Bambusa bambos* and *Bambusa ventricosa* were established under field condition. The cutting raised plants of these species were transplanted in the fields of CSIR-IHBT, Palampur. Five thousand of these well-rooted cutting raised plants were supplied to different agencies for greening of degraded lands in Kangra district during the year, 2017-18. A total of 215 people including villagers, foresters and forest officials from 'Forest Training Institute', Sunder Nagar, H.P. were trained on the methods of raising bamboo nurseries for establishment of plantations. The standardized methods of preparing and raising of bamboo nurseries were also demonstrated (Fig. 43).



Fig. 43 (A-B) Nursery cutting raised plants of *D. hamiltonii* (C-D) forest staff from Forest Training Institute Sunder Nagar, H.P.

The demand for commercial bamboos, particularly, tissue culture raised plants of specific genus/species has increased considerably. Therefore, *in vitro* propagation of three multipurpose bamboos i.e, *Dendrocalamus asper*, *D. hamiltonii* and *Bamboosa balcoa* was carried out to cater to the demands of commercial plant tissue culture industry and forestry. In this regard earlier established micropropagation protocols were improved further (Fig. 44). Rooting percent was very high (>90%) in *D. asper* and *B. balcoa*. In case of *D. hamiltonii* however, around 55% rooting was recorded but hardening was very high (90-95%). Hardened plants were made ready for transfer to industry or for transplantation to forests and degraded lands.

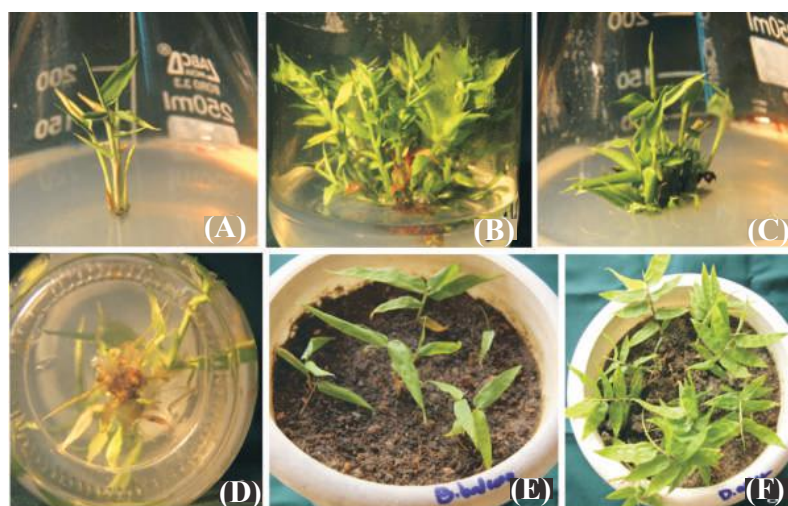

Fig. 44 Micropropagation of commercially important bamboos: (A-C) *in vitro* raised shoot cultures of (A) *Dendrocalamus hamiltonii* (B) *D. asper* (C) *B. balcoa* (D) rooted shoot cultures of *D. asper* (E-F) hardened plants of (E) *B. balcoa* (F) *D. Asper*

## BAMBOO CHARCOAL KILN

This year also the work of conversion of bamboo charcoal continued. Different bamboo species were converted into charcoal. Pine cone, pine needle, *Parthenium hysterophorus* (Congress Grass) and Camphor (Kapoor) wood was transformed into Biochar. Pine needles had took 125-150 percent more time in conversion of biochar and its charcoal recovery was 18-22 percent, whereas other biomass had a recovery percentage of 30-25 percent.

## PORTABLE TYPE BIO CHAR UNIT

Portable type bio char unit was designed and fabricated for conversion of fairly small quantity of charcoal.

## SALE OF BAMBOO CHARCOAL POWDER

Bamboo charcoal powder (200 kg) was sold to M/s Biogen Biotics, New Delhi as sample which was exported to foreign countries for its utility in cosmetics.

## Development of agrotechnologies of other commercially important crops

In addition to medicinal and aromatic crops the agrotechnologies of important industrial crops viz., *Hypericum perforatum*, Hippophae, apple, Quinoa (*Chenopodium quinoa*) were developed.

## QUINOA

A study on effect of vermicompost and pinching on growth and yield of two *Chenopodium quinoa* accessions (IHBT/Q1 and IHBT/Q2) showed that application of vermicompost @ 2.5 t/ha produced higher number of secondary branches and plant spread as compared to higher level (5 t/ha) and control. Number of branches and LAI after 90 days of transplanting was significantly higher in pinched plants as compared to unpinched plants. Accession IHBT/Q2 had significantly higher seed yield than the IHBT/Q1. Similarly, pinching of plants resulted in higher grain yield across the accessions (Fig 45). Highest seed yield was recorded in IHBT/Q2 accession with pinching and 2.5 t/ha level of vermicompost application (Fig 46).

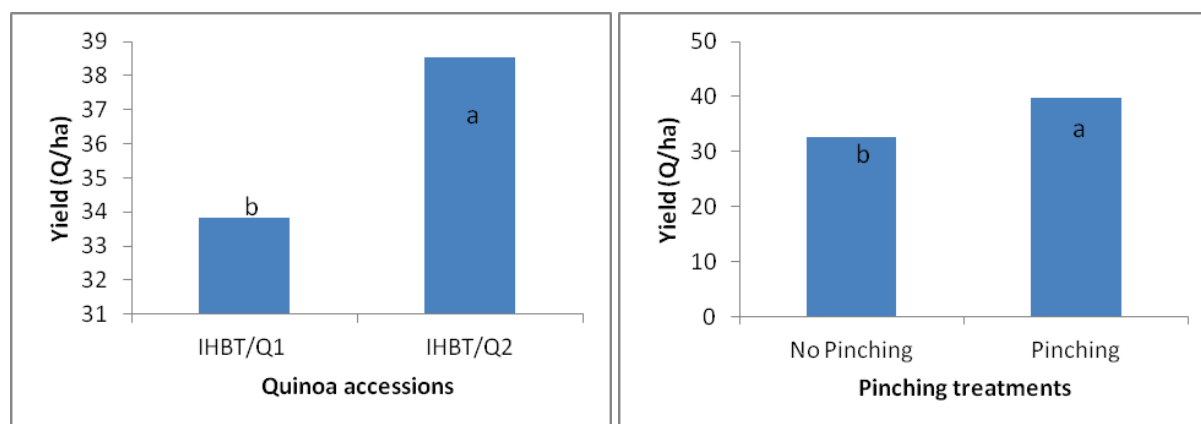

Fig. 45 Seed yield of *Chenopodium quinoa* affected by genotype and pinching treatments



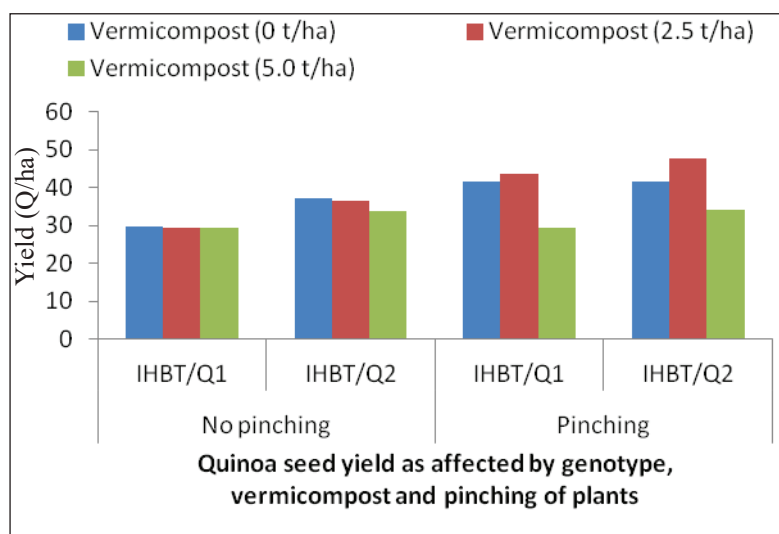

Fig. 46 Seed yield of *Chenopodium quinoa* affected by vermicompost levels and pinching treatments

### Introduction of low chilling varieties of Apple in Mizoram

In addition to the low chilling varieties introduced in 2016 and 2017, this year 800 plants of four low chilling varieties *viz.*, red Fuji, Early Fuji, Sun Fuji and pollinizer variety Scarlett Gala were planted in 32 locations at Champhai district of Mizoram (Table 12). The altitude of locations ranged from 1198 m to 1501 m amsl and N latitude 23° 40' to 23° 67' and E longitude 93° 30' to 93° 36'. The plants which were planted in 2016 started bearing fruits in Champhai (Fig. 47).

Table 12 Apple plants introduced in different locations of Champhai district during January, 2018

Sl. no.	Village name	Farmer's Name	No. of plants
01	Mualkawi	Mr. Zairemthanga	25
02	Mualkawi	Mr. Lianthianga	25
03	Mualkawi	Mr. P.C Liantana	25
04	Mualkawi	Mr. Lalthazauva	25
05	Mualkawi	Mr. E. Lalthneawa	25
06	Mualkawi	Mr C Lalthhuanliana	25
07	Mualkawi	Mr Lalpiangmawia	25
08	Mualkawi	Mr. Lalmangaihtluanga	25
09	Mualkawi	Mr Ramthanga	25
10	Mualkawi	Mr Kaplianhranga	25
11	Mualkawi	Lalrotluanga	25
12	Hnahlan	Mr K. Zoliana	25
13	Hnahlan	Mr Hrangthuami	25
14	Hnahlan	Ms Roseii	25

Sl. no.	Village name	Farmer's Name	No. of plants
15	Hnahlan	K. Laltlanzauva	25
16	Hnahlan	Ms K. Lalniliani	25
17	Hnahlan	Dorikhuma	25
18	Talangsam	Mr H. Hmangaiha	30
19	Tlangsam	Mr Vanlalruatkima	30
20	Tlangsam	Mr V L Siama Fanai	30
21	Vengthlang	Mr Valbuanga	30
22	Vengthlang	Mr C Malswma	30
23	Vengthlang	Mr Valbuanga	30
24	Vengthlang	Mr C. Lianzova	20
25	Vengthlang	Mr. K Lalmawia	8
26	New Champhai	Mr Lalrochanga	30
27	Zotlang	Mr Vanlalchhuanga Varte	10
28	Zotlang	Rinthianghlima	25
29	Vengsang	Mr V. Kawlbuaia	25
30	Vengsang	Mr. Lallawmzuala	25
31	Vengsang	Mr Vanlalringheta	30
32	Vengthlang	Mr Vanlawma	20



**Fig. 47 CSIR-IHBT team interacting with the farmers of Mizoram and monitoring the performance of apple trees**

## INTRODUCTION OF NEW CROPS

### Monk fruit (*Siraitia grosvenorii*)

The fruits of the plant is a good source of low calorie sweet compounds. The sweet taste of monk fruit is primarily due to the presence of a group of cucurbitane-type triterpene glycosides known as ‘mogrosides’. The extracted mixture of mogrosides from monk fruit is about 300 times sweeter than sucrose, and has been approved by the U.S. Food and Drug Administration (FDA).

Mogrosides possesses antioxidative, anti-inflammatory, anticancer, antiviral, antidiabetic and other pharmacological properties (Fig. 48).



Fig. 48 Monk fruit at CSIR-IHBT experimental farm

CSIR-IHBT played a pro-active role in introducing the plant for the first time in India with the help of NBPGR-ICAR, New Delhi (Import Permit No.168/2017). Experiments were also initiated under controlled conditions at CSIR-IHBT, Palampur under vigilance of NBPGR-ICAR, New Delhi.

### Introduction of seabuckthorn varieties from Russia

The elite Russian varieties of seabuckthorn, ‘Altaiskaya’ and ‘Gnom’ were imported from Altai Fito Product Llc, Barnaul (Siberia), Russia through NBPGR (Import Permit number: 382/2017) for introduction in high altitude regions of Himalayas. The plants were raised at CSIR-IHBT, Palampur during the winter months (Fig. 49) and transferred to CSIR-IHBT-Centre for High Altitude Biology, Ribling, Keylong, Lahaul & Spiti (HP).



Fig. 49 Plants of imported Russian varieties of seabuckthorn at CSIR-IHBT experimental farm



# Crop Protection



## Development of Bio-pesticides and Pest Management

### Identification of promising native strains of entomopathogenic fungi (EPF) for the management of insect pests

Field surveys were carried out for collecting insect cadavers/soil samples in different ecosystems in H.P. and surrounding states for isolation, characterization and its evaluation against target pests for their bio-efficacy. Among them, IHBF-1 showed promising toxicity to second instar larvae of diamondback moth (*Plutella xylostella*) (Fig. 1) and aphid (*Aphis craccivora*) (Fig. 2) under laboratory conditions. The isolated strains will be further evaluated against target pests under greenhouse and field conditions for validation and development of bio-pesticide formulations.



Fig. 1 Different stages of second instar larvae of *P. xylostella* infected with IHBF-1



Fig. 2 *A. craccivora* infected with IHBF-1

### Insecticidal activity of plant extracts/ /fractions/compounds/ essential oils

Essential oil (EO) from aerial parts of *Eupatorium adenophorum* Spreng was extracted by steam distillation and characterized by GC and GC-MS.  $\alpha$ -epi-cadinenol (16.63%), *O*-cymene (13.54%), bornyl acetate (7.70%),  $\beta$ -phellandrene (7.46%) and  $\sigma$ -2-carene (5.77%) were the major terpenoids. The EO showed promising toxicity ( $LC_{50} = 3176.50$  mg/L) and repellent activity ( $RC_{50} = 2070.99$  mg/L) to larvae of *P. xylostella* within 24 h. Among fractions, hexane fraction was more effective against *P. xylostella* ( $LC_{50} = 5056.70$  mg/L), and methanol fraction to *A. craccivora* ( $LC_{50} = 1175.80$  mg/L).

Insecticidal activity of tea saponin was studied against larvae of *P. xylostella* and *A. craccivora*. In residual toxicity assay, saponin was found more effective against second instar larvae of *P. xylostella* ( $LC_{50} = 2106.30$  mg/L) and *A. craccivora* ( $LC_{50} = 540.80$  mg/L) after 96 h as compared to positive control (Azadirachtin). In repellent activity study, saponin at 4000 mg/L showed significantly ( $p < 0.0001$ ) higher repellency (48.60%) to third instar larvae of *P. xylostella* and was followed by 3000 mg/L (33.30%) as compared to other concentrations. Feeding preference index (PI) of tea saponin against third instar larva and *P. xylostella* was significantly ( $F_{3,23} = 1.64$ ;  $p < 0.05$ ) lesser (0.63) at higher concentration (4000 mg/L) and was at par with 3000 mg/L as compared to lower concentrations (0.87 to 0.89).

### Acaricidal activity of essential oils against two spotted spider mite (*Tetranychus urticae* Koch)

Eleven essential oils were screened for their fumigant and repellent activity against two-spotted spider mite (*Tetranychus urticae* Koch) under laboratory conditions. In fumigant toxicity assay *Mentha longifolia* L. showed more toxicity to *T. urticae* ( $LC_{50} = 11.00$  mg/L air) and was followed by *M. piperita* L. ( $LC_{50} = 15.80$  mg/L air), *Cymbopogon flexuosus* (Nees ex Steud.) *W. Watson* ( $LC_{50} = 17.20$  mg/L air). In repellent activity test *Acorus calamus* (L.), *M. piperita* and *C. flexuosus* showed 100% repellence to *T. urticae* as compared to *Cedrus deodara* (Roxb.) and *Aegle marmelos* (L.) (76.70%).

### Identification of host cellular targets of AC4 and AV2 proteins of tomato leaf curl Palampur virus and their sub-cellular localization studies

During this year, nine different cellular proteins that interact with AC4 and AV2 proteins of ToLCPalV (*Tomato leaf curl Palampur virus*) were identified through yeast two hybrid screening. AC4 and AV2 are two viral proteins of other begomoviruses and are involved in virus movement, pathogenesis and suppression of gene silencing. AV2 protein was found localized in nucleus and cytoplasm when fused with GFP under the control of 35S promoter. On the other hand, AC4-GFP fusion was localized only in cytoplasm (Fig. 3).

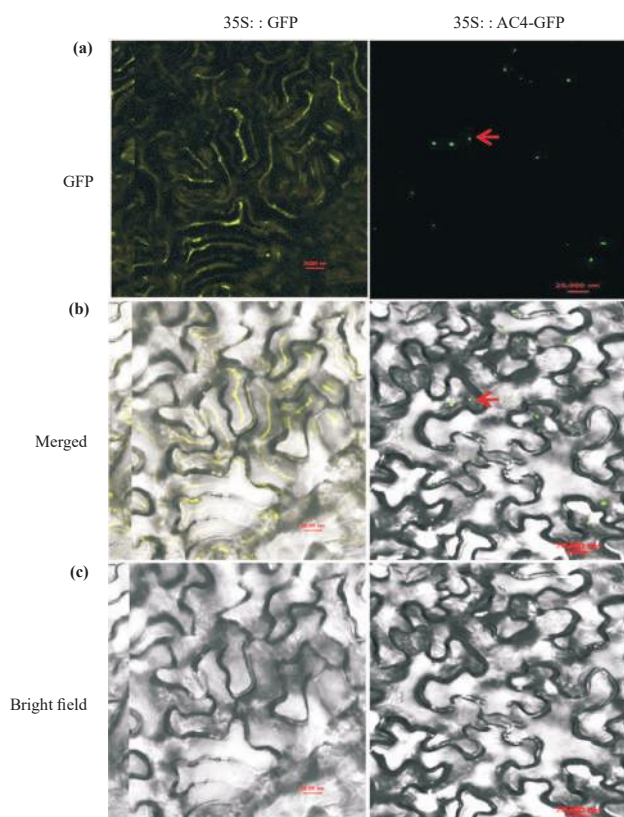

**Fig. 3** Confocal microscopy showing the sub-cellular localization of AC4 and AV2 protein with 35S::GFP and 35S::AC4-GFP. Arrow depicts the localization of AC4-GFP fusion as punctate bodies in the cytoplasm and a, b, c images correspond to GFP, merged and bright field, respectively. Scale bar: 20,000nm



## Molecular characterization of a novel cryptic virus infecting pigeon pea

A new member of the genus *Deltapartiti virus* was identified containing three dsRNAs with an estimated size of 1.71, 1.49 and 1.43 kb. The genomic RNAs were amplified and characterized by sequence independent single primer amplification. The largest dsRNA (dsRNA-1) was identified as the viral RNA dependent RNA polymerase (replicase), predicted to encode a putative 55.34 kDa protein (P1). The two other smaller dsRNAs (dsRNA-2 and dsRNA-3) were predicted to encode putative capsid proteins of 38.50 kDa (P2) and 38.51 kDa (P3), respectively (Fig. 4).

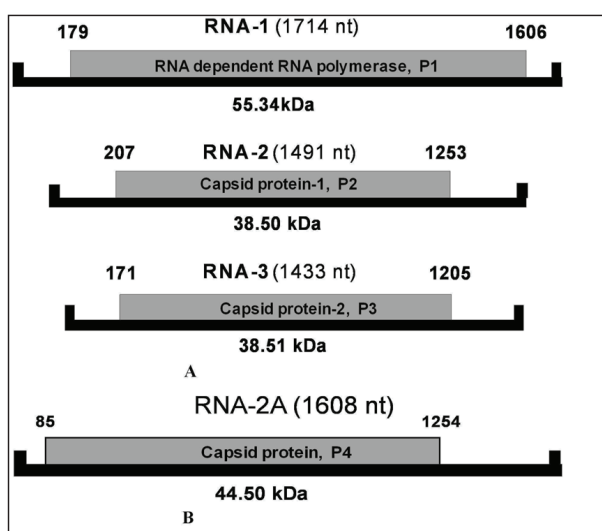

Fig. 4 (A) ArCV-1, dsRNAs (denoted as RNA1, RNA2 and RNA3) are represented by solid black lines. The larger RNA was identified as putative RdRp encoding a single peptide of P1, marked as grey box. The two smaller RNAs encode two individual peptides of P2 and P3 and were identified as putative capsid proteins, marked as grey boxes. (B) schematic representation of a fourth dsRNA isolated along with unusually long 3'-NTR ArCV-1 genome referred to as RNA-2A (Black solid line). It is predicted to encode a putative coat protein P4 marked as grey box

## Molecular characterization of emara viruses associated with pigeon pea sterility mosaic disease

Sterility Mosaic Disease (SMD) of pigeon pea (*Cajanus cajan* (L.) Millspaugh) is a complex disease. Diversity analysis was performed using samples collected from three different locations revealing the presence of pigeon pea sterility mosaic virus-I and II (PPSMV-I and II) from Chevella. However, only PPSMV-II was identified from Bengaluru and Coimbatore through comparative study of dsRNA and small RNA deep sequencing (Fig. 5). PPSMV-I genome consisted of four, while PPSMV-II encompassed six RNAs. The study showed that the N-terminal region of RdRp (SRD-1) of both the viruses contains “cap-snatching” endonuclease domain and a 13 AA cap binding site at the C-terminal were essential for viral cap-dependent transcription and were similar to the members of Bunyaviridae family and that P4 is the movement protein may belong to ‘30 K superfamily’ of MPs.

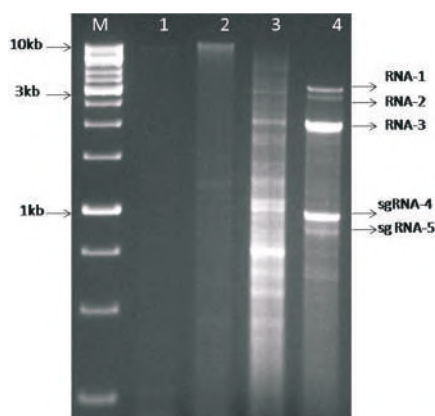
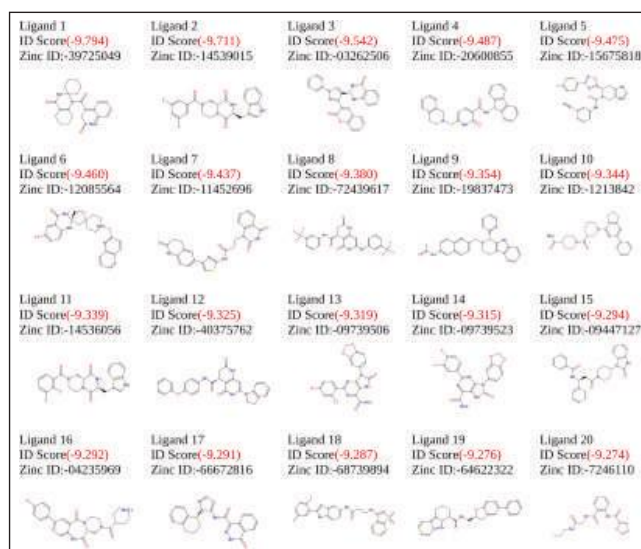

Fig. 5 dsRNA isolated from SMD affected pigeon pea in 1% agarose gel: dsRNA preparation from non-symptomatic *N. tabacum* cv. xanthi (lane 1) and pigeon pea cv. *Errakandulu* (lane 2); dsRNA from SMD affected pigeon pea cv. *Errakandulu* Mg-1, PPSMV-P sub-isolate Chevella, lane 3. dsRNA from *N. tabacum* cv. Xanthi infected with CMV, lane 4, dsRNA size marker. M- Standard DNA marker

### Screening of potential inhibitor against coat protein of apple chlorotic leaf spot virus

Apple chlorotic leaf spot virus is an important latent virus on apple causing yield loss of 10-40%, depending upon different cultivars. Coat protein of ACLSV is a building block of the viral capsid. Different servers such as ConSurf, TargetS, OSML, COACH, and COFACTOR were used for the prediction of active site residues in coat protein. Further, top twenty screened molecules and one potent molecule were considered for further docking analysis.

The above figure shows 2D structure of 20 molecules identified for coat protein. The molecules were selected on the basis of active site binding scores. The number in bracket



(red) depicts the idock binding score in kcal/mol for molecules. The ligands were numbered according to their binding score values from highest to lowest score. The lower binding score of the ligand results in higher binding affinity of ligand molecules with the target protein.

### AV2 protein of tomato leaf curl Palampur virus promotes systemic necrosis in *Nicotiana benthamiana* and interacts with host catalase2

Tomato leaf curl Palampur virus (ToLCPalV), is a bipartite begomovirus. In this study, 10 amino acids from N-terminal region of AV2 were found to associate with the systemic necrosis symptom/phenotype. AV2 protein was found to associate with catalase 2 (Cat 2) through yeast two hybrid assay. AV2 is essential for the pathogenicity, systemic movement and suppression of gene silencing in the host. *N. benthamiana* inoculated with PVX at 14 dpi showed higher

accumulation of ROS in PVX-AV2 infiltrated leaves (Fig 6). The interaction between AV2 and cat2 might play a crucial role in the establishment of ToLCPaIV infection.

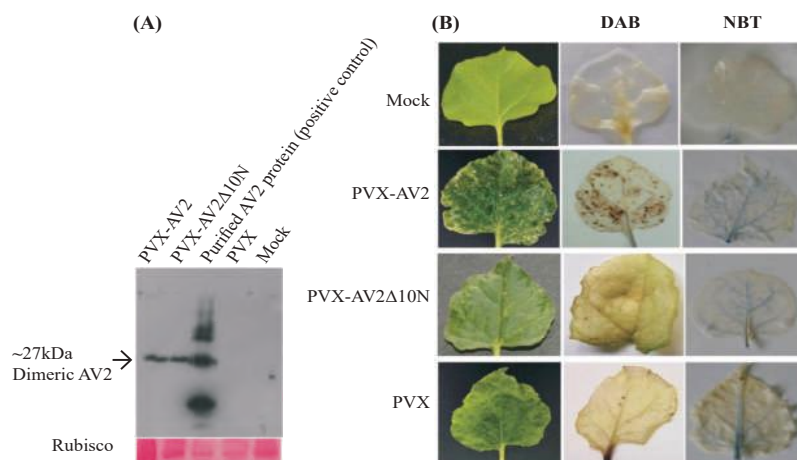

**Fig. 6 (A)** Western blot was performed with AV2 antisera to detect the expression of AV2 in *N. benthamiana* leaf samples infiltrated with PVX-AV2, PVX-AV2Δ10N at 14 dpi. PVX mock infiltrated samples; and purified AV2 protein were used as negative and positive controls, respectively. **(B)** DAB and NBT staining for detection of H<sub>2</sub>O<sub>2</sub> and O<sub>2</sub><sup>-</sup> radicals in PVX-AV2, PVX-AV2Δ10N and PVX inoculated *N. benthamiana* at 14 dpi, showing the higher accumulation of ROS in PVX-AV2 infiltrated leaves

**Movement protein of apple chlorotic leaf spot virus is genetically unstable and negatively regulated by ribonuclease E in *E. coli***

Movement protein (MP) of apple chlorotic leaf spot virus (ACLSV) belongs to “30 K” superfamily of proteins. The MP gene of ACLSV was found to be genetically unstable in *E. coli* when transformed DH5α cells were grown at 28 and 37 °C. However, the transformants were able to grow at 20 °C. The negating effect of RNase E on transcript stability and expression was confirmed by northern blotting and quantitative RT-PCR of the RNA extracted from RNase E temperature sensitive mutant (strain N3431) (Fig. 7).

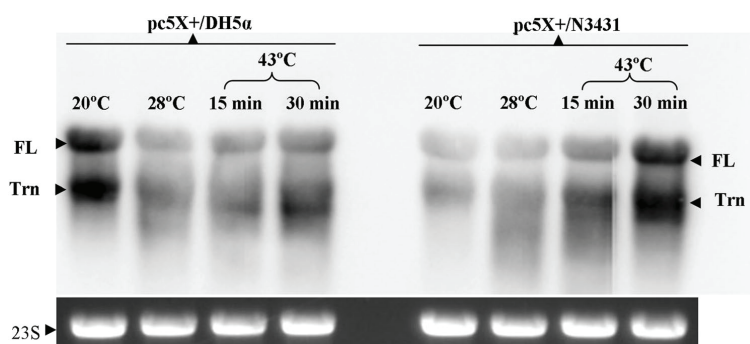

**Fig. 7** Northern blot image showing fate of chimeric ACLSV MP mRNA in *E. coli* DH5α (left panel) and rnets mutant (right panel). The chimeric plasmid pc5X+ was transformed into DH5α cells (pc5X+/DH5α) and into rnets (pc5X+/N3431). The DH5α panel shows higher accumulation of both full-length (FL) and truncated (Trn) transcripts at 20 °C as compared to 28 and 43 °C samples. Higher accumulation of FL in samples collected after 30 minutes of shifting to non-permissive temperature (43 °C) compared to FL at 20 and also 28 °C (permissive temperature) and after 15 min of shifting to non-permissive temperature (43 °C) in pc5X+/N3431 samples

## Potato

### Genome wide identification and expression analyses of TIR-NBS-LRR genes in potato against early blight disease

Potato, is the most important non-cereal food crop worldwide. It is prone to diseases caused by bacteria, fungi, viruses and mycoplasmas. Among them, early blight (*Alternaria solani*) is the most destructive foliar disease. Therefore, 44 TIR-NBS-LRR (TNL) genes encoding 60 proteins were identified using highly stringent computational methods. The TNLs were characterized on the basis of conserved protein motifs, gene duplication events, chromosomal locations and phylogenetic relationships. The transcript expression of a few genes was also checked for insights into the genetic regulation during pathogen attack. The TNLs are subset of the gene family, NBS-LRR, and are responsible for almost 80% of resistance genes identified till date in plant system against different pathogens (Fig. 8).

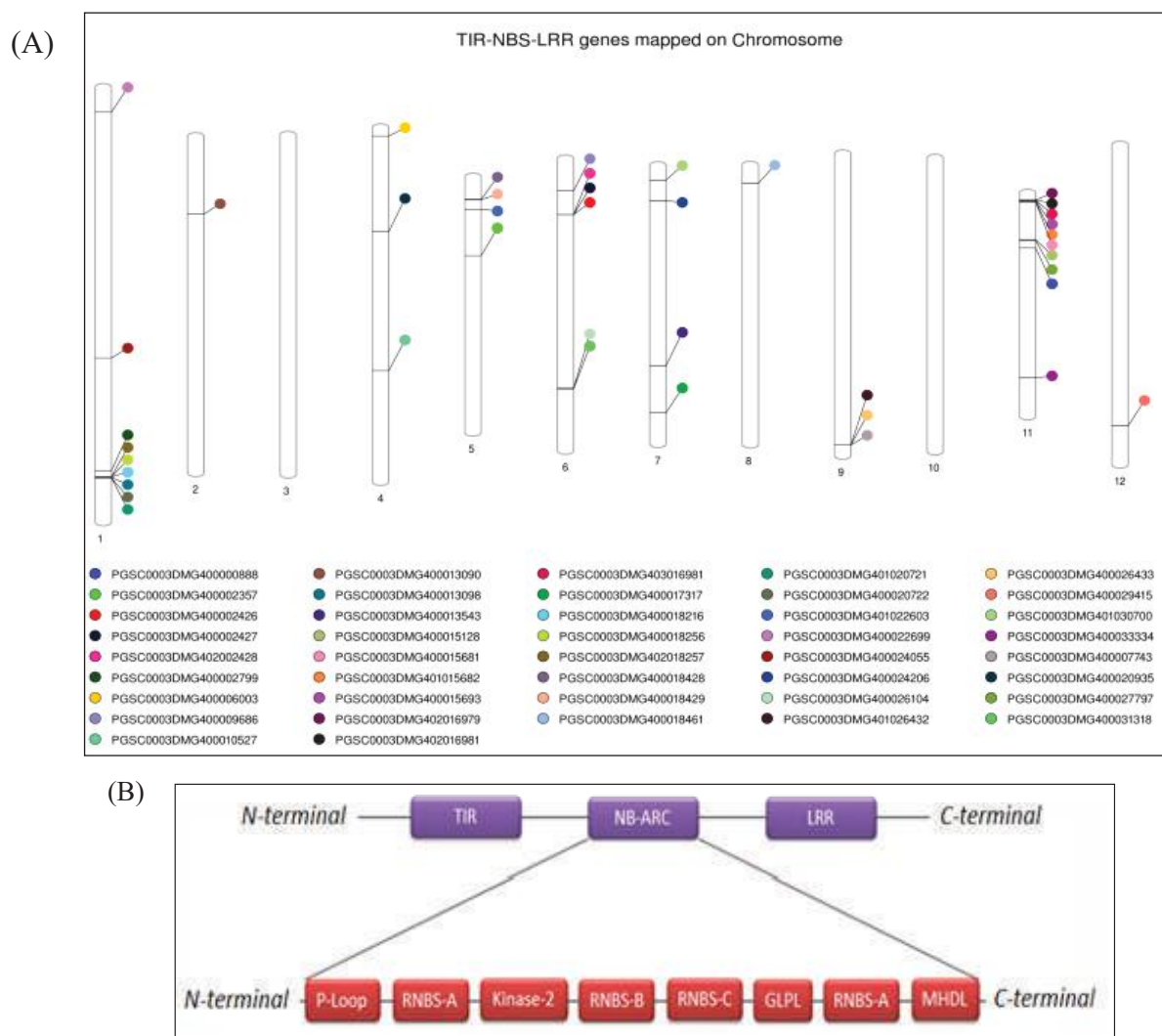

Fig. 8 Images A and B showing diagrammatic representation of identified potato TNLs chromosomal localization and their consensus motif structure of NB-ARC

### Development of microbial formulations to serve as stress buster and biofertilizers to increase crop productivity in stressed agriculture

In continuation to previous activity on identification of stress tolerant, plant growth promoting rhizobacteria, field trials were initiated at farmer's field at Kuhli Khurd-Ludhiana (Punjab) for onion and Sulah, dist Kangra (H.P.) for garlic (Fig. 9A). A total of nine PGPRs were tested including the one provided by CSIR-NBRI, CSIR-NIIST and CSIR-NEIST. The IHBT strain of *Pseudomonas azotoformans* and NIIST-300 yielded the best results for onion crop as compared to control (FYM / NPK). The shelf life of selected strains with different solid carriers were tested in order to develop bioformulations. Talc powder showed best result as compared to active charcoal and vermiculite both at 4°C and room based bio formulations (Fig 9B).

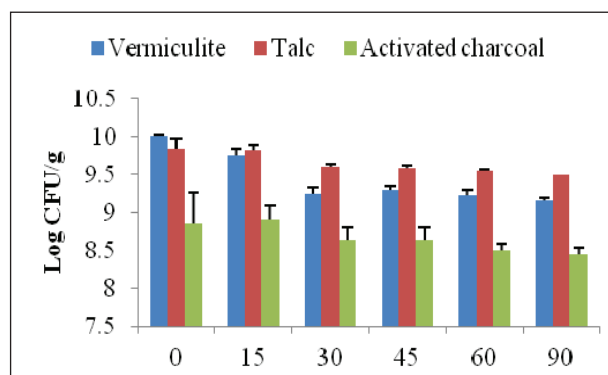

Fig. 9 (A) Field trial experiments on onion at Ludhiana, Punjab.  
B) shelf life of PGPRs with different solid carriers

### Development of biopesticides

In the area of biopesticides, *Beauveria bassiana* isolates from the soils associated with dead larval cadavers was collected from forest area of Kullu district (H.P.). The isolate was cultured, characterized, multiplied and evaluated under the laboratory conditions. It showed efficacy against larvae of Diamondback moth, *Plutella xylostella*, adults and nymphs of Aphids, *Aphis craccivora*, and mite, *Tetranychus urticae* after 7 days of treatment.



# CSTR Skill Development Programs





## CSIR SKILL DEVELOPMENT PROGRAMS

The institute under the National Skill India Mission signed an MoU with the Agriculture Skill Council of India (ASCI) on agriculture & allied sector under the aegis of National Skill Development Corporation (NSDC), Ministry of Skill Development & Entrepreneurship, Government of India on October 12, 2017. The MoU covers the skill training programmes aligning with ASCI and developed qualification packs as per National Skill Qualification Framework (NSQF) on gardener, greenhouse operator, hydroponics technician, floriculture (protected cultivation), medicinal plant grower, plant tissue culture technician, essential oil extractor, bamboo grower and nursery worker. Under the scope of this agreement, ASCI may conduct assessment of people trained under different short term skill based training programs at the Institute. Successful candidates will be awarded certificates by the ASCI and CSIR-IHBT as per NSQF, either singly or jointly.

In the current year, the institute conducted three skill development courses for gardener, hands-on laboratory experiment, analytical exposure, and diploma in laboratory practices in Animal House. These skill courses fall under Agriculture Skill Sector, Life Science Skill Sector and Healthcare Skill sector. The courses were of 8-12 weeks duration in which candidates were given field and laboratory trainings, exposure to implements and equipments, training on recording and reporting as per good lab practices. The candidates were evaluated on the given assignments at individual level and also examined by the Institute. The successful candidates got good placements in their respective fields (Fig. 1).



**Fig. 1 Skill development activities at CSIR-IHBT**

An incubatee was trained for pulverisation technique of bamboo charcoal. 10 trainees were trained in skill development and 2 trainees successfully qualified the examination conducted by the Institution of Ministry of Medium, Small and Medium Enterprises, Regional Directorates of Apprenticeship Training (North Region) Faridabad.



*Incubation Centre at CSIR-IHBT*



## **INCUBATION CENTRE AT CSIR-IHBT**

CSIR-IHBT has been recognised as one of the incubation centres by Department of Scientific and Industrial Research and Micro Small and Medium Enterprises, Govt. of India. The institute has signed MoU with the government of Arunachal Pradesh on February 23, 2017 for participation in “Chief Minister’s Start-ups/Innovation Projects/New Industries Schemes” to assist start-ups/entrepreneurs.

Technical competency and facilities exist within the institute to guide the start-ups for networking, infrastructure development, awareness and up-scaling in the area of food processing, nutraceuticals, enzymes and mass propagation of plants. Facilities for distillation of essential oils, extraction of steviol glycosides, cell and tissue culture units are also made available for the benefit of the individuals, start-ups and MSME’s during their incubation period. The institute encourages strong linkages with MSMEs. Active interactions are being pursued to encourage individual entrepreneurs (start-ups/ stand-ups), micro and small scale industries to utilize the facilities of the incubation centre. Turn-key issues are being supported to promote business of small and medium entrepreneurs. Opportunities are being explored to tie up with various government agencies, private companies and multiple industries.

The following facilities are being offered to the start-ups:

- NIR composition analyser
- Single screw extruder
- Texture analyzer
- Encapsulation facility
- Freeze drying unit for fruits/vegetables
- Flaking unit
- Sparkler filter
- Encapsulation unit
- Pulveriser wet/dry
- Centrifugal separator
- Sorter and washer
- Helicoidal juice extractor
- Rotavapour unit
- Adsorption column
- Vaccum packaging unit
- Dehumidifier
- Cold storage room

The following processing facilities at CSIR-IHBT campus are available for usage by the MSEs on case to case basis:

- Distillation of essential oils, from medicinal and aromatic crops.
- Extraction of steviosides from stevia.
- Extraction of dietary fibers from apple pomace, pomegranate, amla and other fruits.
- Bamboo candies and other value added products from bamboo.
- Tea based beverages: tea concentrates for preparation of soft drinks, tea wines, black and green herbal teas
- Extraction of catechins from tea leaves
- Raising of tissue culture plants of RET MAPs, ornamentals, apple, bamboo, potato, rose etc.
- Soil testing
- Animal testing and preclinical trials
- Pac Bio analysis
- Pesticide residue testing

**Currently ten incubatees are incubating their progressive ideas at CSIR-IHBT Incubation Centre. These include:**

S. No	Name of Incubatees	Idea of Start-up and Start date
1.	<b>Mr. Sahil Dutta</b> Pine Villa, Below HIMUDA Colony, Sector – 6, Dharamshala (H.P.) Contact no. 7831012202	Mango panna, Apple and Amla honey juice formulations 25 <sup>th</sup> September, 2017
2.	<b>Mr. Paritosh Bhardwaj</b> VPO, Kand Gwal Tikker, Tehsil Palampur, Distt. Kangra (H.P.) Contact no. 9459252890	Ready to serve healthy beverages such as medicated and iced Kangra tea development 25 <sup>th</sup> September, 2017
3.	<b>Mr. Rakesh Kumar</b> Village Dhanyater, P.O. Chauntra, Tehsil Joginder Nagar, Distt. Mandi (H.P.) Contact no. 9857999888	Herbal green tea, black tea and blends of different tea products 25 <sup>th</sup> September, 2017
4.	<b>Mr. Aman Patial</b> #60/4, Bhojpur Sundernagar (H.P.) Contact No. 9816484577	Honey vinegar from waste honey 25 <sup>th</sup> September, 2017
5.	<b>Mr. Akash Patial</b> #60/4, Bhojpur Sundernagar (H.P.) Contact No. 9816860577	Fruit burfi from different seasonal fruits such as guava, mango, apple, amla etc. 25 <sup>th</sup> September, 2017
6.	<b>Mr Chandan Sood</b> Phase – 7 Mohali, Punjab Contact no. 7045018453	Agro-technology e-market platform 13 <sup>th</sup> February, 2018
7.	<b>Mr Sandeep Kumar</b> VPO Trilokpur, Teh. Jawali, Distt – Kangra (H.P.) Contact no. 9805620466	Potato seed production through plant tissue culture and aeroponic facility 13 <sup>th</sup> February, 2018

**Other incubatees at CSIR-IHBT, Palampur**

S. No.	Name	Thrust Area	Contact person
1.	M/s. Root and Flowers	Processing technology for value added crispy fruit product	Ms. Sonu Rana, Palampur, (H.P.)
2.	M/s. Himalaya Natural and Herbal Products	Formulate stevia liquid drops.	Mr. Udhey Singh, Bundla, Palampur (H.P.)
3.	M/s Biogen Biotics	Producing bamboo charcoal powder	Mr. Vansh Lagwal, K 117, First floor, Aashirwad complex, Green park, New Delhi
4.	M/s. Access Indian Impex Centre Pvt. Ltd., 602 Naurang House, 21 Kasturba Gandhi Marg, New Delhi	Nutri bar and granola bars	-
5.	M/s. Dexter Retail and Distribution Pvt. Ltd., 21 Kasturba Gandhi Marg, New Delhi	Herbal khichri, protein mixes	-
6.	M/s. Baijnath Pharmaceutical, Paprola, Dist. Kangra, (H.P.)	Extraction of catechins from tea leaves	-

**INCUBATION FACILITY**

A memorandum of understanding was signed between the Institute and M/s Biogen Biotics, K117, Aashirwad Complex, 1st Floor, Green Park, New Delhi-110016 for training and use of institute infrastructure for manufacture of bamboo charcoal powder.





AcSIR-IHBT



### AcSIR- IHBT

The Academy of Scientific and Innovative Research (AcSIR) was established in 2010, by a resolution of the Government of India on 17<sup>th</sup> July, 2010. As formalized by an Act of Parliament; that is the Academy of Scientific and Innovative Research Act, 2011 vide The Gazette of India, dated 7th February, 2012 was notified on 3rd April, 2012 as an Institution of national importance. It was set up based on a 'Hub and Spoke' model; where the hub comprising of the AcSIR offices is responsible for centralized administrative functions. The spokes located in the 37 laboratories and 6 units of CSIR spread along the length and breadth of India, act as actual campuses for different subjects or disciplines.

Under the banner of Academy of Scientific and Innovative Research (AcSIR), CSIR-IHBT initiated the PhD (Sciences) programme. During the period between January, 2011 to March, 2018, a total of 140 students enrolled for Ph.D. at CSIR- IHBT. Admissions in the Ph.D. program in Biological Sciences & Chemical Sciences are summarized in the following graph:

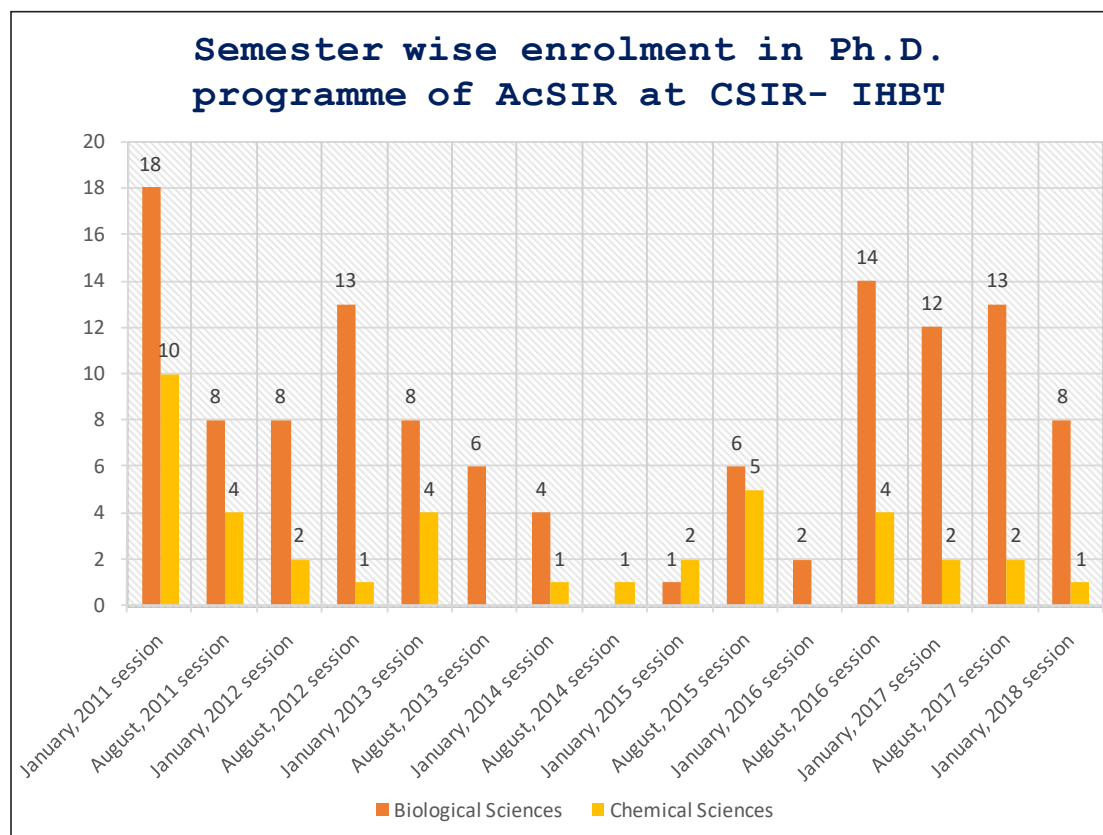

During the period between, April, 2017 to March, 2018, 12 students presented their research work in Open Colloquium and 18 students were awarded Ph.D. degree after successful defence of their thesis in the viva voce examination.

The details of the students who were awarded Ph.D. degree during April, 2017 to March, 2018 is as under

Sr. No.	Name	Supervisor	Thesis title	Year of Completion
1.	C. Bal Reddy	Dr. Pralay Das	Methodology Development for Palladium Catalyzed Carbon-Carbon and Carbon-Heteroatom Bond Formation Reactions	2017
2.	Kiran Mansingh Rawat	Dr. Y.S. Padwad	Elucidating the role of natural and synthetic molecules for their anticancer activity	2017
3.	Manoranjan Kumar	Dr. Bikram Singh	Studies on Utilization of Biobased Reagents for the Synthesis of Amines and <i>N</i> -heterocycles	2017
4.	Monika Bhunia	Dr. Sanjay Kumar	Identification and Functional Characterization of Universal Stress Proteins in <i>Arabidopsis thaliana</i> under Abiotic Stress Conditions	2017
5.	Rahul Mohan Singh	Dr. Vipin Hallan	Expression Analysis and Identification of Host Factor(s) Associating with Movement Protein of <i>Apple chlorotic leaf spot virus</i>	2017
6.	Richa Bharti	Dr. Pralay Das	Methodology Development for the Synthesis of Bioactive Benzocycloheptene Analogues from Himachalenes	2017
7.	Rishu Thakur	Dr. Arvind Gulati	Diversity Analysis and Selection of Rhizobacteria for Growth Promotion in <i>Camellia sinensis</i> (L.) O. Kuntze	2017
8.	Sandeep Kumar	Dr. Pralay Das	Synthesis of Transition Metals Nanoparticles as Heterogeneous Catalysts for Hydration, Oxidation and C1 Insertion Reactions	2017
9.	Surender	Dr. Vipin Hallan	Virome Study of Pigeonpea Sterility Mosaic Disease in Pigeonpea ( <i>Cajanus cajan</i> ) by Small RNA Sequencing and Sequence Independent Amplification Approaches	2017
10.	Saurabh Sharma	Dr. Rakesh Kumar	Effect of Mulching and Growth Regulating Factors on Growth, Yield and Quality of <i>Stevia rebaudiana</i> Bertoni in the Western Himalayas	2017

Sr. No.	Name	Supervisor	Thesis title	Year of Completion
11.	Anish Kanchara	Dr. Sanjay Kumar	Studies on the effect of co-overexpression of selected genes of carbon and nitrogen metabolism in <i>Arabidopsis thaliana</i> (ecotype Col-0)	2018
12.	Anita Kumari	Dr. Sanjay Kumar	Transcriptome analysis and molecular response of <i>Sinopodophyllum hexandrum</i> (Royle) T.S. Ying to environmental cues	2018
13.	Ashish Kumar	Dr. Vijai K. Agnihotri	Phytochemical Investigation of <i>Saussurea lappa</i> , <i>Costus speciosus</i> and <i>Jurinea macrocephala</i> form Western Himalaya	2018
14.	Onkar Singh Nayal	Dr. Sushil K. Maurya	Development of Metal Based Lewis Acid Catalysed Approaches for C-N bond Formation Reactions and their Mechanistic Insights	2018
15.	Poonam Roshan	Dr. Vipin Hallan	Functional Characterization of AV2 Protein of <i>Tomato leaf curl Palampur virus</i>	2018
16.	Shikha	Dr. Sudesh Kumar	Functional Characterisation of Drought Responsive Genes from Horsegram [ <i>Macrotyloma uniflorum</i> (Lam.) Verdc.] in Transgenic <i>Arabidopsis</i>	2018
17.	Vanita Patial	Dr. Amita Bhattacharya	Micropropagation and Over-expression of PkSWRKY Transcription Factor in <i>Picrorhiza kurroa</i>	2018
18.	Vinod Bhatt	Dr. Bikram Singh	Phytochemical and Synergy-Directed Biological Studies of <i>Zanthoxylum</i> Species	2018



## Important Events





## IMPORTANT EVENTS

### Rural Development Officers visit to CSIR-IHBT

A delegation of officers related to rural development from Champai district, Mizoram visited the institute on May 23, 2017 to have a look at research activities in labs and interacted with scientists and acquired knowledge regarding the activities going on. The delegation included Mrs. K. Lalrijoli, Additional Secretary, Government of Mizoram.



Interaction of rural development officers at CSIR-IHBT

### Visit of Indian Forest Service Probationers to CSIR-IHBT

“Foresters should generate knowledge of forest resources, evaluate ecosystem services, facilitate conservation and rehabilitation of rare, endangered & threatened (RET) plants and disseminate traditional knowledge for the benefit of mankind and improving livelihood of the people” said Dr Sanjay Kumar, Director of CSIR-Institute of Himalayan Bioresource Technology, Palampur. He was addressing a group of 45 Indian Forest Service probationers, who visited the Institute as a part of their hill tour under the leadership of Dr. P. Viswakannan, IFS from Indira Gandhi National Forest Academy, Dehradun. The group was shown various activities relevant to forests such as conservation and domestications of RET plants of medicinal importance, germplasm of bamboo and other plants, impact of climate change on the plants species under FACE (free air carbon dioxide enrichment) and FATI (free air temperature increase) facilities, monitoring plants with RAMS (Remote Air Monitoring System) facility. The group had exposure of different labs and fields of the Institute, as coordinated by Dr Sanjay Uniyal and Er Amit Kumar. Dr Viswakannan and visiting team expressed their gratitude to Institute for adding scientific dimension for understanding forest wealth and its sustainable utilization.



IFS probationers with Director and Scientists



Interaction with Scientist

### **HP Directorate of Industries and CSIR-IHBT to Jointly Promote Innovation in the State**

An agreement (MoU) was signed between CSIR-Institute of Himalayan Bioresource Technology, Palampur and Directorate of Industries, Shimla to recognize CSIR-IHBT, Palampur as incubation centre to undertake business incubation and entrepreneurship development activities. This incubation centre will support the startups as well as innovative projects by way of mentoring services, access to the labs, facilities



**Exchange of MoU document between Director IHBT and Directorate of Industries, Shimla**

etc. on a free-of-cost basis. Under this agreement an active program would be run in the region for identification, creation and translation of business ideas suitable for new venture creation in order to convert educated youth from job seekers to job creators. Under this MoU there is a provision to provide Rs. 25,000/- per month to the innovation projects as sustenance allowance for one year after being recommended by CSIR-IHBT Palampur and approved by the Empowered Committee. Marketing/commercialization assistance of maximum of Rs. 10 lakh will be provided to the innovation projects to launch its products/services in the market.

Key focus area of the scheme are technology driven innovation in sectors, like, rural infrastructure and facilities, crafts, arts, water and sanitation, renewable energy, healthcare, clean tech, agriculture, horticulture and related areas, food processing, retail, tourism and hospitality, mobile, IT and ITes including hardware and biotechnology.

### **Visit of the 'Parliamentary Standing Committee on Science & Technology, Environment & Forests'**

The director extended a warm welcome to the Hon'ble Chairperson and committee members for visiting the Institute premises. He said that this is a proud and historical moment for the Institute. He escorted the PSC members to the bamboo museum and apprised the Hon'ble members that the museum depicts diversified products of bamboo and showcases Institute's activities and products. It is meant to appreciate and popularize the beauty of this humble grass that grows so abundantly in the Himalayan region can be used for multiple purposes.



The Hon'ble Chairperson and committee members visiting the bamboo museum facility



The Hon'ble Chairperson and committee members enquiring about the products of the Institute

The Hon'ble members visited the Biodiversity farm of the institute wherein *ex-situ* conservation initiatives of the institute were available for first-hand information. Information on medicinal and aromatic plants growing in the conservatories was provided to the committee members. The Hon'ble members showed keen interest in stevia. They tasted its leaves and appreciated the efforts of the institute in removing bitterness of stevia. The Hon'ble members were also apprised about the distillation and processing facilities of the institute.



The Hon'ble Chairperson and committee members visiting the field facilities



The members also visited the floriculture farms and green houses. The Hon'ble members took note of the different floriculture varieties that the Institute is working upon and the ones that the institute has developed. Thornless rose and Agapanthus in full bloom were key points of discussions.



The Hon'ble Chairperson and committee members visiting the floriculture fields



In addition to *ex-situ* conservation measures in the field, the Hon'ble members visited the tissue culture laboratory and saw practical work in progress. The Hon'ble members were apprised of the protocols that the institute has developed for carrying out tissue culture of rare and endangered plants of the Himalayan region. The Hon'ble members also visited and appreciated the hydroponics and aeroponics facilities at the institute.



**The Hon'ble Chairperson and committee members visiting the tissue culture facility**

The Hon'ble members visited the tea garden of the institute wherein they were apprised of the different varieties, management practices, and mechanization initiatives were undertaken by the institute. Various products such as tea wines and ready to drink tea were displayed and members tasted different types of tea.



**The Hon'ble Chairperson enquiring about the tea mechanization initiatives**



**The Hon'ble Chairperson and committee members viewing the diversified tea products developed by the Institute**

The members also took keen interest in the pilot plant facility of the institute and practically saw the processes and products being developed by the institute at pilot scale.



**The Hon'ble members visiting the Pilot plant facility**

### Jigyasa Programme

CSIR-Institute of Himalayan Bioresource Technology organized a Jigyasa programme from 10-July 14, 2017. Jigyasa is a student-scientist connect programme between Council of Scientific and Industrial Research (CSIR) and Kendriya Vidyalaya Sangathan (KVS). The programme was inaugurated by Dr. Sanjay Kumar, Director CSIR-IHBT in the premises of the institute. Eminent scientist, Dr. O.P. Sharma delivered the keynote lecture that was attended by school students and others. Shri Lalit Kumar, Principal KV, Holta, Palampur also addressed the students. During the week long programme, students of class XI visited the state-of-the-art laboratories in the area of biotechnology, bioinformatics, natural product and synthetic chemistry, internationally recognized herbarium, remote sensing and mapping facilities, animal house facility, pilot plants for nutraceuticals, essential oil and herbals. Extensive school level experiments were specially designed for them so that the students could get hands on exposure to latest scientific techniques and equipments. Under the Jigyasa programme, students from different Kendriya Vidyalayas visited institute on different occasions *viz.* CSIR-IHBT Platinum Jubilee Technofest, National Science Day and other occasions.

#### Details of activities conducted under Jigyasa programme

Date	Program Name	No. of days	No. of KV Schools	No. of students	No. of teachers
10-14.7.17	Jigyasa	5	1	120	8
21-23.8.17	CSIR-IHBT Platinum Jubilee Technofest	2	1	136	5
16.10.2017	Lab Visit	1	1	93	7
15.12.2017	Lab Visit	1	1	22	2
19.12.2017	Lab Visit	1	1	30	3
30-31.01.2018	Faculty Training Programme	2	2	-	24
28.02.2018	National Science Day	1	1	41	2
<b>Total</b>			<b>8</b>	<b>442</b>	<b>51</b>



Different activities under Jigyasa Programme



Different activities under Jigyasa Programme

### CSIR-IHBT Platinum Jubilee Technofest

As a part of its Platinum Jubilee celebrations, CSIR showcased scientific and technological innovations made by its 39 constituent laboratories spanning across the entire country in different fields of science and technology. CSIR- Platinum Jubilee Mega Exhibition was organised at CSIR-IHBT Palampur from August 21-23, 2017. Students from the KVS were invited to visit and interact with the scientists during this Techno Fest. The exhibition was categorized into 14 themes viz. Aerospace & Strategic Sector, Agriculture & Floriculture, Chemical & Petrochemical, CSIR-Rural development, Ecology & Environment, Energy, Engineering & Infrastructure, Food & Nutrition, Generics & Healthcare, Intellectual Property, Enabling Leather, Materials/Minerals/ Mining, Nurturing Human Resource and Water. The exhibition provided a great opportunity to students to get a glimpse of the scientific achievements of CSIR.



Interaction of students during CSIR-IHBT platinum jubilee

### Seminar Series-2017

Seminars provide a great platform for networking, learning and gathering interdisciplinary knowledge. Therefore, a Research Scholar's Seminar Series was organized on 21 September, 2017. The event marked the CSIR-Foundation Day celebrations and saw the participation of all the scholars of the institute. Scholars from different fields like Food Technology, Ecology, Nanoparticles, Molecular Biology, Bioinformatics and therapeutics, Chemical processes, Plant science and Microbiology participated and oriented their research under the theme 'Bioeconomy, Bioresources, Himalaya, Product & Processes'. The event was inaugurated by the Director, Dr. Sanjay Kumar. A total of 24 research scholars participated in the seminar competition. All the presentations were highly appreciated by a packed audience and a panel of jury headed by Dr. O. P. Sharma, Ex. Director, IVRI, Palampur (H.P.). Presentations were followed by discussions which led to the exchange of ideas. Poonam Roshan, Bipasha Bhattacharjee and Sanyukta Darnal were selected as the top three speakers of the day.



Seminar series 2017 conducted by students at CSIR-IHBT

The event was special in the sense that it was completely conceptualized and organized by the scholars of the institute. Dinesh Thakur, Maheshwar Singh Thakur, Pradeep Singh, Shudh Kirti Dolma and Sourabh Soni were the conveners of the event.

### Visit of Minister

Dr. Ram Lal Markanda, Minister of Agriculture, Tribal Development, Information and Technology, Government of Himachal Pradesh visited the institute on 23 January 2018. He visited various labs and was apprised about the R & D activities and technologies, and also products developed in the institute.



Visiting dignitaries at CSIR-IHBT



The Hon'ble Minister of Agriculture, HP visiting the field facilities

### Faculty Training and Motivation Programme

CSIR-IHBT conducted Faculty Training and Motivation Programme for local school teachers from January 30 to 31, 2018. Twenty four teachers from two KVS participated in this programme. The course was specially designed to upgrade the knowledge of chemistry and biology teachers. During the programme teachers got a glimpse of research capabilities and ongoing activities of the institute. In addition, special demonstrations were arranged in labs and hands on trainings provided in plant tissue culture, DNA isolation & DNA finger printing, isolation and detection of natural compounds, chemical characterization of tea and development of value added products, nanotechnology and microbiology. The programme concluded with an interactive session. The teachers mentioned that the training programme was highly beneficial and it also helped them in gaining new concepts.



Faculty Training and Motivation Programme at CSIR-IHBT

### National Science Day

CSIR-Institute of Himalayan Bioresource Technology, Palampur celebrated National Science Day on February 28, 2018 with great enthusiasm to commemorate the discovery of the famous “Raman Effect” by Sir CV Raman, for which he was awarded the Nobel prize in physics in 1930. On this day, a science exhibition was organized by the institute for the students of different schools and colleges in the region. Several activities and demonstrations on isolation of natural compounds, distillation of essential oil, plant tissue culture, microbial techniques, nanotechnology, plant identification, mapping, toxicity testing and insect rearing were organized. The students were also educated on recent technologies like DNA barcoding, toxicity analysis, application of nano-science, mass multiplication of plants, chemical profiling.



The agrotechnologies for increasing income of the farmers, tea planters, and floriculturists were also exhibited.



National science day activity at CSIR-IHBT

### Visits of school, college, university students and faculties

Regular visits of students and teachers from different schools, colleges, universities and institutes were conducted at CSIR-IHBT. The visits exposed the teachers and students to the latest development in the field of science and technology. Apart from the Jigyasa programme, 973 students and 57 faculty members from different colleges and universities from seven states visited the institute on various occasions.

### Details of College/University students and faculty members visited CSIR-IHBT during 2017-2018

S. No.	College/ University/ Institutes	Date	No. of Students	No. of faculty members
1.	College of Horticulture and Forestry, Neri, Hamirpur (HP)	03.04.2017	62	01
2.	RRMK Arya Mahila Maha Vidyalaya, Pathankot (PB) (B.Sc. & M.Sc.)	17.04.2017	51	03
3.	DAV University, Jalandhar (PB) (B.Tech.)	20.04.2017	19	02
4.	Carrier Point University, Hamirpur (HP) (M.Sc. Chemistry)	09.05.2017	32	02
5.	Delhi University, Delhi (Ph.D)	26.05.2017	3	02
6.	GGDSD college, Rajpur, Palampur (CSIR Platinum Jubilee Celebrations Exhibition)	21.08.2017	71	01
7.	SCVB Govt. Degree College, Palampur (CSIR Platinum Jubilee Celebrations Exhibition)	22.08.2017	90	02
8.	GGDSD Degree college, Rajpur, Palampur (CSIR Platinum Jubilee Celebrations Exhibition)	23.08.2017	76	01
9.	Shere-E-Kashmir, University of Agriculture (J&K)	28.08.2017	55	03
10.	Laureate Institute of Pharmacy, Jwalamukhi (HP) (M. Pharma)	06.09.2017	15	03

S. No.	College/ University/ Institutes	Date	No. of Students	No. of faculty members
11.	Institute of Information Management & Technology (IIIMT), College, Aligarh (UP)	15.09.2017	33	03
12.	GGSDS College, Rajpur, Palampur (HP) (Adoption)	22.09.2017	27	02
13.	RGM Govt. College, Jogindernagar (HP)	27.09.2017	25	01
14.	Punjabi University, Patiala (PB)	27.10.2017	47	02
15.	Banglore Univeristy, Bengaluru, Karnataka	31.10.2017	20	01
16.	Yeshwantrao Chavan College of Engineering, Nagpur (M.H.)	07.12.2017	50	03
17.	Kanwar Durga Chand Govt Degree College (KDC), Jaisinghpur, Distt Kangra (H.P.)	15.12.2017	07	01
18.	Ganpat Sahai P.G. College, Sultanpur (U.P.)	12.02.2018	25	01
19.	Mata Gujri College, Fatehgarh Sahib (P.B.)	23.02.2018	43	03
20.	Govt. Degree College, Dharmshala (H.P.)	28.02.2018	73	02
21.	P.G. Khalsa College, Amritsar (P.B.) (Botany)	05.03.2018	41	04
22.	SRM University, Sonipat (H.R.) (M.Sc. Chemistry)	07.03.2018	08	03
23.	Punjab Agriculture University, Ludhiana (B.Sc. Agriculture)	19.03.2018	11	02
24.	Panjab University, Chandigarh (M.Sc. Microbiology)	23.03.2018	30	01
25.	Lingaya's Vidyapeeth University, Faridabad (H.R.) (B.Sc. Biotech)	26.03.2018	17	03
26.	Lyallpur Khalsa College, Jalandhar (B.Sc. Biotech)	27.03.2018	42	05
<b>Total</b>			<b>973</b>	<b>57</b>

#### Details of school students and faculty members visited CSIR-IHBT during 2017-2018

S. No.	School/ Occasions	Date	No. of Students	Faculty members
1.	Cambridge International School, Palampur, (HP)	03.05.2017	59	03
2.	Cambridge International School, Palampur, (HP)	15.05.2017	89	03
3.	CSIR Platinum Jubilee Celebrations Exhibition at CSIR-IHBT, Palampur (HP)	21-23.08.2017	1614	68
4.	KLM International School, Pathankot (PB)	12.09.2017	12	02
5.	Govt. Middle School, Bhatillu, Bhawarna (HP)	20.09.2017	19	04

S. No.	School/ Occasions	Date	No. of Students	Faculty members
6.	76 <sup>th</sup> CSIR Foundation Day	04.10.2017	122	10
7.	Gurukul Academy Public School, Sandhol, Mandi (HP)	16.10.2017	30	06
8.	Tibetan Children's Village (TCV) School, Goplapur (HP)	26.10.2017	55	02
9.	Govt. Sr. Sec. School, Bhalet, Distt. Hamirpur (HP)	22.11.2017	84	08
10.	Govt. High. School, Duga, Distt, Hamirpur (HP)	08.12.2017	33	05
11.	Govt. High. School, Dodhamb (HP)	22.12.2017	41	04
12.	Govt. Sr. Sec. School, Ghallour (HP)	05.02.2018	52	05
13.	Govt. Sr. Sec. School, Tamber (HP)	29.01.2018	19	03
14.	Govt. Boys Sr. Sec. School, Dharamshala (HP)	02.02.2018	23	06
15.	Govt. Sr. Sec. School, Punner Distt. Kangra (HP)	15.02.2018	36	06
16.	Udaan School, Kandbari, Distt. Kangra (HP)	22.02.2018	15	06
17.	National Science Day	28.02.2018	409	23
<b>Total</b>			<b>2712</b>	<b>164</b>



Intrraction of school students with faculty member and researcher of CSIR-IHBT



Celebration on the occasion of CSIR foundation day



Smt. Sarveen Chaudhary, Urban Development, TCP & Housing Minister, Himachal Pradesh visited the institute on March 23, 2018. Dr. Sanjay Kumar, Director of the institute welcomed the minister by presenting a bouquet of flowers

*Business Development and Marketing Unit  
(BDMU)*



## BUSINESS DEVELOPMENT AND MARKETING UNIT (BDMU)

This unit is making all efforts to convert high end R&D technologies into the business. BDMU is involved in economic and social impact analysis, organizing scientific & industrial meets, promoting technologies, responding to the queries of farmers and entrepreneurs regarding different technologies, facilitating technology transfers through Agreements, Material Transfer Agreements (MTAs), Incubation Facilities under “Chief Minister’s Start up Scheme”, need based incubation, processing of disseminating technologies and products to the society.

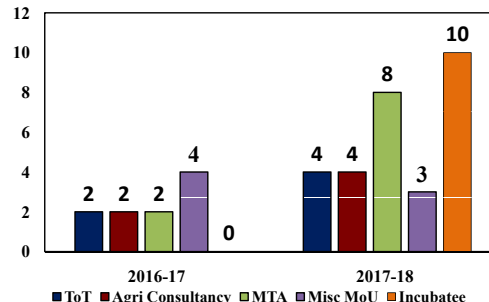

During 2017-18, BDMU assisted in the signing of four technology transfers. Eight material transfer agreements (MTAs), three MoU’s, two with different government institutions and one with private company. Three agreements for agriculture consultancy services and agreement to provide incubation facility were also signed with ten parties in different innovation projects under “Chief Minister’s Start up Scheme” and Need Based Incubation Facility. BDMU was also intensively involved in showcasing the institute’s technologies and products in various business meets, trade fairs and exhibitions at regional as well as national levels.

BDMU also undertook other activities including evaluation of techno-economic feasibilities of technologies developed at CSIR-IHBT, drafting agreements for transfer of technology, material transfer agreements, agreements with incubatees, MoU’s with government institutes, responding to queries of clients, raising expression of interest (EOI) for different technologies, raising FVC for timely payment of GST related to CSIR-IHBT, socio-economic impact analysis of technologies/ services from third parties and providing inputs for drafting technology specific documents.

### Participation in Exhibitions/ Technology Promotion Programmes

S. No.	Programme	Duration
1.	CSIR exhibition at Parliament Annexe, New Delhi	7-14/08/2017
2.	CSIR exhibition at Vigyan Bhawan, New Delhi	26/9/2017
3.	CSIR exhibition during an event “North East Calling” organised by the Ministry of Development of North Eastern Region (DoNER), Government of India	9-10/9/2017
4.	CSIR exhibition during an event “BEST – Be an Entrepreneur of S&T” at Andhra University Campus, Visakhapatnam	25/01/2018
5.	CSIR exhibition at residence (New Delhi) of Hon’ble Minister of Science & Technology	10-13/01/2018
6.	Exhibition during Holi Mela Festival	27-28/02/2018
7.	CSIR exhibition during Indian Science Congress at Imphal	16-20/03/2018





राजभाषा गतिविधियां



## राजभाषा गतिविधियां

### हिंदी दिवस

संस्थान में दिनांक 14.09.2017 को हिंदी दिवस समारोह का आयोजन किया गया। संस्थान के कर्मियों ने इसमें प्रतिभागिता की। डॉ. संजय कुमार, निदेशक ने अपने अध्यक्षीय संबोधन में सभी कर्मचारियों से सरल हिंदी में कार्य करने का आह्वान किया। इससे पूर्व संस्थान के हिंदी अधिकारी श्री संजय कुमार ने निदेशक एवं सभी कर्मियों का स्वागत करते हुए हिंदी दिवस की पृष्ठभूमि तथा संघ की राजभाषा नीति पर संक्षेप में प्रकाश डाला। इसके साथ ही उन्होंने संस्थान में राजभाषा हिंदी में किए जा रहे प्रशासनिक एवं वैज्ञानिक कार्यों की जानकारी प्रदान की। इसके पश्चात श्री आलोक शर्मा, प्रशासन अधिकारी ने कर्मचारियों को धारा 3(3) के अनुपालन राजभाषा संबंधी आवश्यक निर्देशों एवं जांच बिन्दुओं की जानकारी दी।



### हिंदी व्याख्यान

राजभाषा में कार्य को प्रोत्साहित करने के उद्देश्य से संस्थान में दिनांक 04.01.2018 को एक हिंदी संभाषण का आयोजन किया गया। संभाषण के उद्देश्य पर प्रकाश डालते हुए डॉ. बृज लाल, वरि. प्रधान वैज्ञानिक ने मुख्य अतिथि का परिचय भी करवाया। समारोह के मुख्य अतिथि एवं वक्ता डा. अरुण चंदन, क्षेत्रीय निदेशक, राष्ट्रीय औषधीय पादप बोर्ड के उत्तर क्षेत्रीय सुविधा केन्द्र, आयुर्वेदिक औषधीय उद्यान, जोगिन्द्रनगर-हि.प्र. ने "आयुर्वेद के संरक्षण एवं संवर्धन में प्रौद्योगिकीय चुनौतियां" विषय पर प्रस्तुतिकरण दिया। अपने प्रस्तुतिकरण में डॉ. चन्दन ने आयुर्वेद की दृष्टि से महत्वपूर्ण पादपों के संरक्षण एवं उन पर वैज्ञानिक शोध हेतु वैज्ञानिकों एवं शोध छात्रों को प्रेरित किया। अपने अध्यक्षीय संबोधन में ऐसे संभाषणों को राजभाषा से समायोजित कर उनकी सार्थकता को उजागर किया। उन्होंने डा. चन्दन द्वारा अपने संभाषण में उठाए गए मुद्दों पर कार्य करने तथा आरसीएफसी की शोध गतिविधियों में सहयोग की बात पर सहमति जताई। इसमें संस्थान के सभी वैज्ञानिकों, अधिकारियों, कर्मचारियों एवं रिसर्च स्कॉलर ने प्रतिभागिता की।

### राजभाषा निरीक्षण

दिनांक 4-5 मई 2017 को वैज्ञानिक तथा औद्योगिक अनुसंधान विभाग (डीएसआईआर), नई दिल्ली के प्रतिनिधि श्री अ. न. जेना तथा श्री अनिल कुमार, वरिष्ठ अनुवादक ने संस्थान के राजभाषा संबंधी कार्यों का निरीक्षण किया।

### कार्यशाला में प्रतिभागिता

मानव संसाधन विकास केन्द्र, वैज्ञानिक तथा औद्योगिकी अनुसंधान, एच.आर.डी.सी. (सी.एस. आई.आर.), गाजियाबाद में 27-28 जून 2017 को "राजभाषा नीति के प्रभावी कार्यान्वयन पर कार्यशाला में संस्थान की ओर से श्री संजय कुमार, वरिष्ठ अनुवादक ने प्रतिभागिता की।

सीएसआईआर – मानव संसाधन विकास केन्द्र, गाजियाबाद  
राजभाषा नीति के प्रभावी कार्यान्वयन विषय पर कार्यशाला  
दिनांक 27.06.2017-28.06.2017



### राष्ट्रीय संगोष्ठी में प्रतिभागिता

सीएसआईआर-आईआईटीआर द्वारा 11-13 अक्टूबर 2017 को पर्यावरण प्रदूषण: चुनौतियां एवं रणनीतियां अंतरराष्ट्रीय संगोष्ठी में संस्थान की ओर से डॉ. मनोज कुमार, वैज्ञानिक तथा श्री संजय कुमार, हिंदी अधिकारी ने प्रतिभागिता की। डॉ. मनोज में पेपर भी प्रस्तुत किया।

### वेबसाइट अद्यतनीकरण

संस्थान की वेबसाइट की सामग्री को समय-समय पर अद्यतन किया गया।

### पुस्तकें, पत्रिकाएं एवं संदर्भ सामग्रियों को उपलब्ध कराना

राजभाषा विभाग, भारत सरकार एवं परिषद् मुख्यालय द्वारा समय-समय पर जारी निर्देशों के अनुरूप हिन्दी में कार्य करने के लिए उचित वातावरण बनाने और राजभाषा हिन्दी में मूल रूप से कार्य करने को प्रोत्साहित करने के लिए हिन्दी में प्रकाशित सहायक सामग्रियों जैसे पुस्तकें, कोश, पत्रिकाएं और अन्य संदर्भ साहित्य संस्थान में उपलब्ध करवाया। इसके अतिरिक्त विभिन्न प्रयोगशालाओं/संस्थानों द्वारा प्रकाशित पत्रिकाओं को भी संस्थान में उपलब्ध करवाया गया। इस वर्ष 59412 रुपये की हिंदी पुस्तकों की खरीद की गई। हिंदी पुस्तकों की सूची संस्थान की वेबसाइट पर उपलब्ध है।

### राजभाषा संबंधी कार्यान्वय

- नए कार्यभार ग्रहण करने वाले कर्मचारियों को राजभाषा नीति एवं संस्थान में राजभाषा अनुभाग के कार्यों के बारे में व्यक्तिगत रूप से अवगत करवाया गया। इसके अतिरिक्त प्रशासन में संदर्भ सामग्री भी हिंदी में उपलब्ध कराई गई।
- हिंदी की तिमाही रिपोर्ट के लिए विभिन्न अनुभागों/प्रभागों से आंकड़े प्राप्त कर रिपोर्ट सीएसआईआर मुख्यालय भिजवाई गई।
- राजभाषा कार्यान्वयन की दिशा में वार्षिक कार्यक्रम एवं सीएसआईआर मुख्यालय से प्राप्त निर्देशों के अनुपालन हेतु आवश्यक आदेश जारी किए गए।
- संस्थान की राजभाषा कार्यान्वयन समिति की सितम्बर व दिसम्बर 2017 की तिमाही बैठकों का एजेंडा बनाया, बैठक का आयोजन, कार्यवृत्त तैयार करना एवं परिपत्र एवं कार्यालय ज्ञापन जारी किया गया।
- विभिन्न अनुभागों से प्राप्त कागजातों का हिंदी अनुवाद उपलब्ध करवाया गया। संस्थान द्वारा किये जा रहे शोध कार्यों को आम जनता तक पहुंचाने के उद्देश्य से ब्रोशर आदि के लिए सामग्री का अनुवाद एवं प्रकाशन।

### विविध कार्य

संस्थान द्वारा आयोजित किए जाने वाले विभिन्न समारोहों जैसे सतर्कता जागरूकता सप्ताह, कौमी एकता सप्ताह, सद्भावना दिवस, सीएसआईआर स्थापना दिवस, आईएचबीटी स्थापना दिवस, विभिन्न कार्यशालाओं/समारोहों के आयोजनों, निमंत्रण पत्र, विज्ञापन, प्रेस नोट आदि को तैयार करके प्रैस-मीडिया को उपलब्ध कराया गया।

## Support Services



## **PLANNING PROJECT MONITORING & EVALUATION**

### **Research Planning**

Coordinated a series of meetings and facilitated furnishing of information for Apex Committee meeting. For constant updating, 24 institutional data on various domain was uploaded on C-DIS portal during 2017-18. The cell recorded initiation of 27 new projects funded by various agencies. As a part of routine activity, updation and maintenance of databases pertaining to project, staff, paper, patent, ECF, royalty, MoU, resource management etc were carried out. To facilitate decision making, PPME carried out monitoring of institutional performance w.r.t publication, ECF, patent and technology transfer. It also compiled institutional information for CSIR Annual report. It conducted 55<sup>th</sup> Meeting of Research Council of IHBT, Palampur on 24-25<sup>th</sup> November, 2017 at Palampur and supported all follow-up actions, besides organizing the Joint Parliamentary Committee meeting on 18-21 June, 2017 at Manali, followed by a visit to the Institute on 21-23 June 2017. It also furnished information regarding 27 parliament questions received from the CSIR. In addition to above, following events were organized:

### **CSIR Foundation Day**

The Institute celebrated the 76<sup>th</sup> Foundation Day of its parent organization CSIR on 4<sup>th</sup> October 2017. Dr. S.S. Handa, Ex-Director, Indian Institute of Integrative Medicine (CSIR-IIIM) was the chief guest of the function. He delivered a lecture on “MAPs-rich repository of health care products: Challenges & Opportunities”.

### **Jigyasa**

477 students and 29 faculty members from Kendriya Vidyalaya were exposed to the scientific advancements at the Institute from 10-14<sup>th</sup> July 2018.

### **Faculty Training & Motivation Programme for School Science Teachers**

Twenty four science teachers from the thirteen nearby schools were updated on the recent developments in the field of Chemistry and Biology on 30-31 January 2018.

### **National Science Day**

The Institute celebrated National Science Day on 28<sup>th</sup> February 2018. On this open day about 600 students and faculty from different schools and colleges visited the institute.

### **Resource planning and monitoring**

The institute facilitated the allocation of funds and monitoring the expenditure related to R&D as per the needs and mandate of the Institute. It also coordinated meetings to plan new infrastructure and equipments. Besides catering to manpower need of the Institute. Appropriate steps were also taken to seek approvals and induct new manpower.

### **Right to Information**

Furnished information on 72 queries under RTI Act and filed quarterly report to RTI portal [www.rti.gov.in](http://www.rti.gov.in). Two cases were received for appeal.

## IT based activities

Developed and launched a new website of “Aromatic Oils from Himalayas” the Institute. The updates were promptly posted in facebook and tweeter. Information were regularly updated and flashed in intranet. Through in house efforts the CSIR-IHBT Alumni Portal, Analytical Services facility for internal and external users, Training Schedule Form were developed and mechanism was put in place to record visitor’s data online.



Home Online Form

### Training Schedule

Show: 10 entries

S.NO.	Name	Title of the Training	Funded By	Project	Funding Agency	Email Address	From	To	Venue	Training Fee
1	Dr. Ashish R. Warghat	Nature India-India Alliance Science communication and career workshop	Non-CSIR		DST (Nature India)	ashishwarghat@ihbt.res.in	17/04/2018	17/04/2018	JNU, Delhi	zero

Showing 1 to 1 of 1 entries

Previous 1 Next

**Contact Us**  
 CSIR - Institute of Himalayan Bioresource Technology  
 Palampur  
 Phone: +91-1894-233339  
 Fax: +91-1894-230433  
 E-mail: director@ihbt.res.in

Records

### Visitor's Diary

from: dd-mm-yyyy to: dd-mm-yyyy

Name of Visitor(s):

Name: \_\_\_\_\_

Address & Designation: \_\_\_\_\_

Address & Designation: \_\_\_\_\_

Institute's Nodal Person: \_\_\_\_\_

Institute's Nodal Person: \_\_\_\_\_

Remarks: \_\_\_\_\_

Remarks: \_\_\_\_\_



## ENGINEERING SERVICES UNIT

### (A) Sabbatical Home

The building has 4 sabbatical units with an area equivalent to Type IV quarter. The building is totally furnished and has a sit out at roof terrace. The building was inaugurated by Hon'ble Chief Minister, Sri Jai Ram Thakur.



Sabbatical Home and Inauguration by Hon'ble Chief Minister, Sri Jai Ram Thakur

### (B) Construction of 16 Nos. Houses (Work in progress)

The construction of 16 houses comprising of 4 quarters of type V, 8 quarters of type IV and 4 quarters of type III was started. The project is likely to be completed in July 2019.



Bhumi Pujan and construction of Type V, IV and III quarters

### (C) Renovation of Existing Farm Store: Community Hall

The old farm store structure was renovated and attached toilets and kitchen were provided. Old leaking roof was replaced, new tile flooring and ceiling were provided. The renovated hall can be now used for small functions. The area of the hall is 150 sqm.



Community Hall before and after construction

#### (D) Net & Poly Houses

Two polyhouses of area 400 sqm and 6 net houses with area of 1020 sqm were constructed to facilitate farm/field and other R & D activities.



Net and Poly Houses facilities

#### Other minor construction/upgradation activities

- Room for security and Chandpur toilet upgradation
- Shed for Bamboo Treatment Plant
- Upgradation of road sides-toe walls and bitumastic road repair
- R.C.C. Nalla near Old Lab
- Parking in Old Lab
- Upgradation of gents toilet of Old Lab
- Footpath from bridge to Guest House check post

- Drying shed and storage godown for Ayurveda Department.
- Algae propagation tanks and shed
- Upgradation of 6 nos. houses at Scientist Apartment
- Parking shed for Hostel building
- Safety fencing along Hostel
- Aluminium safety grills for Girls Hostel
- Concreting of Girls Hostel rear lawn along basement
- Upgradation of Biotech. basement lab
- Bioprocess lab upgradation
- Widening of Road i/c speed breakers and glow studs
- Provision of covered drain along both road ends linking to highway
- Multi play station for parks in new colony and Bharmat colony
- Link corridor from old lab to Pilot Plant.
- Widening of chowk near guest house.
- Provision of stainless steel railings along all stairs and ramps.
- Space for snacks and coffee dispenser near pentagon.
- Covered space for instruments near HATS lab.
- Upgradation of house no. M-23 at housing board colony.

## ADMINISTRATION

The Administration provides a variety of support services for conducting R&D in the laboratory. The division has synchronized itself to realize the vision of CSIR-IHBT and facilitated the overall system to meet the set goals and targets. The division has significant roles in every phase of a staff's career development and provides continued support from recruitment to superannuation. Administration connects all staff as a central unit and facilitates academic aspirations, career progression, housing and health care needs. The administration does the following:

- Formulates and implements policies concerning administrative procedures for smooth functioning of the institute.
- Provides advice to functional bodies (Committees/Functional groups) within the organization.
- Maintains liaison with CSIR Headquarters on matters related to administration.
- Provides healthy working conditions and environment in the laboratory through interpretation as well as implementation of governing rules and regulation.
- Assists the authorities of the laboratory, namely, the Director, the Head of Departments and the Principal Investigators on issues and decisions of administrative nature.

The division is headed by the Administrative Officer, who is the over all In-charge of the activities. He is supported by Section Officers, a group of Assistant Section officers, Senior Secretariat Assistants, Junior Secretariat Assistants and supporting staff including Security Services and

Hindi cell. The security department which is headed by a security assistant is responsible for the safety and security of the institute.

In recent past, the Administration has undergone major transformation in terms of work culture and implementation of paperless processes. An improved work culture and decentralized leadership were introduced at all levels to bring the desired changes. A trend of faster service delivery system has been inculcated in the staff to match the expectations of CSIR-Enterprise Transformation initiative.

In addition to the above, Administration initiated action for delivering lectures for awareness of all the staff members on the Administration Rules & Regulations applicable during their service i.e. TA/LTC Rules/ Leave Rules/ GFR/ Advance etc. In this context, a lecture on "Preventive Vigilance & other related issues" was delivered by the Administrative Officer.

Administration is taking fast pace action for filling up of vacant 20 Scientific, 04 Technical & 01 Administrative posts.

## **FINANCE & ACCOUNTS**

Finance & Account section is playing a vital role in the management of finances and providing support to scientific, technical as well as other administrative officials. The division manages the activities of budgetary control and adopts remedial measures for optimum utilization of allocation according to the guidelines of CSIR. In addition to this, it maintains accounts of the institute as per CSIR guidelines and also provides services for effective planning, utilization and post utilization of grants received grant-in-aid sponsored consultancy, collaborative projects and technical services aid.

Broad activities of Finance and Account section are:

- Assisting and advising Director on financial, auditing and accounting related matters.
- Preparation and compilation of revised estimates and budget estimates of the institute.
- Management of financial resources received from CSIR, GAP, Sponsored, CNP & CLP projects.
- Ensuring scrupulous implementation of financial directives of the Government of India.
- Offering financial concurrence to the proposals developed in the institute.
- Keeping liaison with CSIR- HQ on financial, accounting and audit related matters.
- Co-ordinating the duties related to CAG and CSIR internal audit and providing their replies.
- Authorization of the payment to all suppliers, contractors and service providers.
- Authorization of the payment to all employees for their official and personal claims.
- Maintenance of various accounting records as per CSIR guideline.
- Maintenance of various records of bank debits, credits, DD, NEFT, RTGS, etc.
- Finalization of pension, family pension, timely issuance of PPOs and timely payment of pensionary benefits.
- Investment of resources from laboratory reserve funds.

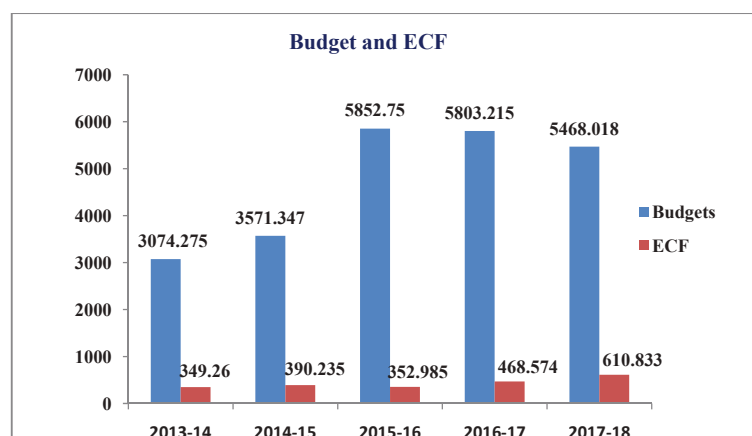

## STORE & PURCHASE

The Store & Purchase division is mainly responsible for the procurement of capital equipments from India and abroad, purchase of spares and consumables items, Annual Maintenance Contracts (AMCs) of equipments, Annual Rate Contracts (ARCs) for chemicals, etc. The division also maintained a minimum inventory of routine consumable items such as office stationary, cleaning items, hardware, plumbing, etc. Technical & Purchase Committees, Purchase Committees and Standing Disposal Committee helped the division to take suitable decisions as per the CSIR procedure. The division also co-ordinated activities between indenting, planning, accounts, administration, vendor and various agencies like bank, customs, insurance, transportation, clearing and forwarding agents etc.

### The major procurements made during 2017-18

- DSLR Professional Camera
- Temperature Control Unit
- Multipurpose Essential Oil Field Distillation Units
- Pilot Scale Rotary Evaporator System
- Incubator Shaker
- Fully Automatic Top Loaded Vertical Autoclave
- Ultra Microbalance
- Flash Chromatography System
- Unified Network Storage System
- Solvent Purification System
- EVOS FL Auto 2 Cell Imaging System
- Two-port Inert Atmosphere Glove Box
- Computer Node
- Complete Canning Unit for Food
- Complete Fruit Freeze Drying Unit

## COMPUTER SECTION

This section takes care of existing IT resources in the institute which has a fleet of servers from HP, IBM, supermicro used for hosting website, DNS, centralized antivirus solution, intranet website etc.

Institute is one of the nodal points of NKN (National Knowledge Network) connectivity as a part of CSIR Programme under the premise of Govt. of India's National Programme, in which a dedicated 1Gbps WAN link is provided to the institute on optical fiber backbone through which wired (LAN) & wireless internet facility were provided in the campus including hostel and faculty residences. It has 35 managed switches and 65 indoor and outdoor wireless access points. This year, Internet facility was extended to newly constructed Sabbatical home and Pilot plant. All the internet users are managed centrally with the help of authenticator.

Network security hardware used for LAN & WAN comprises of almost 35 high speed managed switches, Unified Threat Management System (UTM/Firewall), web application firewall, wireless authenticator, wireless controller on high availability and its policies were deployed to protect IHBT resources centrally. Also facilitated virtual classroom and video-conferencing facilities for the Institute.

As a routine job, this cell constantly extended services related to network, computers and peripherals over local area network in the campus and coordinate AMC for Computer & Peripherals.

### **LIBRARY: IHBT-Knowledge Resource Centre (IHBT-KRC)**

As a continuous activity, the library of the institute procured and managed a range of knowledge resources including research journals in online & print format books, subject encyclopaedias, research reports, online and CDs databases, theses in the field of science and technology. Various activities were performed by the library to support research and academic projects by providing the services such as reference and consultation, circulation, document delivery, reprographic, resource sharing, information alert, user awareness using ICTs for web based library management and services to users. In this way, library contributed in generating new knowledge by the researchers of the institute.

Further, assistance and relevant information were provided on impact factor of journals, publishers' guidelines to authors, publishing policy of journals for selecting quality journals for publication of their research articles as well as online submission of research articles. The books procured were 199 and 9 theses were added to the library collection.

Database of books, journals other documents housed in library were fed in the KOHA software. The documents having availability on internet can be viewed for their physical structure and layouts. The database of library can be accessed through- <http://library.ihbt.res.in>.

**Library OPAC:** The database of library can be accessed via the Online Public Access Catalogue (OPAC) which is searchable. The database has facility for view on-line checkout status, reservation of books, and users can recommend new books, journals, etc. online besides indicating the status of a particular document. The user can check status of the issued books through KOHA software. Database can be searched by keywords, author, title, publisher, accession number, subject, ISBN, etc. at <http://14.139.59.218/> in addition to a link in library website.

**National Knowledge Resource Centre (NKRC):** The institute has been the part of NKRC, a national consortium of CSIR and DST libraries with an aim to provide a wide range of quality knowledge resources. The library has been the founder member of this consortium. Scientists and scholars of the institute are being facilitated to access more than 2500+ e-journals of all major publishers, patents, standards, citation and bibliographic databases through this consortium. Apart from licensed resources, NKRC is also a single point entity that provides its users with access to a multitude of open access resources.

**Citations:** The staff of library is continuously providing inputs on citations and preparation of citation report of scientists. The reports were prepared by consulting the international resource like Web of Science, SciFinder and Google scholar.

**User orientation:** This activity has been a continuous activity as every new scholars, project staff are joining the institute. New eighty six users were imparted training on resources available, the arrangement of books and journals, services provided by the library, accessing of online journals, OPAC and databases.

**E-Mail Alert:** The library provides Email Alert Service for the circulation (Issue/Return) of the user's and various other activities of the library.

**Plagiarism (Similarity Check):** Library provides a similarity check software called iThenticate that allows detecting of similarity from article's, thesis/dissertation, project report, or any other research related work.

**Reference Service:** More than 655 queries related to books, journals & journal articles and specific research topics were attended to with print and online resources. These include bibliographic as well as full text of references.

**Photocopy and printing service:** Printing of different types of the documents for communication of knowledge to society such as scientific & technical brochures, advertising material & flyers of technology developed, official documents, project proposals and project reports by scientists, scholars and staff of the institute, binding of documents was also being facilitated.

**Newspapers clipping service:** Sixteen daily newspapers of Hindi and English languages were subscribed in the Library. All the newspapers subscribed were scanned and marked important, News related to activities of the institute and scientific items were disseminated to scientists for information. Library managed newspaper clippings blog at- <http://ihbtinnews.blogspot.in/>.

During the year, the library was visited by 4885 visitors including scientists, students, research scholars and faculty members from several academic and R&D institutions to consult library resources and to access more than one lakh accesses from online resources. Library provided photocopying/ laser printing services to scientists, research scholars and staff of the institute.





## Publications



## INTELLECTUAL PROPERTY CREATED

### Patent(s) Filed

Sreenivasulu, Y., Sharma, I., Srinivasan, R., Bhat, SR., Ahuja, PS. (2017) A novel embryo sac specific bidirectional promoter from Arabidopsis, Patent Application Number: 201717019580.

Agnihotri, VK., Kumar, A., Walia, M., Koundal, R. (2017) Process for development of value added products from extraction waste of rose oil/water, Patent Application Number: 201711040192.

### Patent(s) Granted

Das, P., Sharma, D., Singh, B. (2017) Acetone to 3-(2,4-cyclohexanone)-propyl carboxylic acid ethyl ester (chpc): a novel versatile intermediate for value added organic molecules synthesis. Patent Application Number: 0677DEL2010, IN Patent Number: 289113, Granted on dated, 02/11/2017.

Kaachra, A., Kumar, S., Vats, SK., Ahuja, PS., Kumar, S. (2017) A method for enhancing status of carbon, nitrogen, biomass and yield of plants. Patent Application Number: MX/a/2013/012185, MX Patent Number: 346985, Granted on dated, 19/04/2017.

Singh, H.P., Rana, A. (2017) An economical process for purification of bio amino acids. Patent Application Number: 2014-556200, JP Patent Number: 6186379, Granted on dated, 04/08/2017.

Bhardwaj, P.K, Kumar, A., Kishore, A., Ghawana, S., Rani, A., Singh, K., Singh, H., Singh R.S., Kumar H., Sood, P., Dutt, S., Kumar, S., Ahuja, P.S. (2017) A method for cloning functional gene of copper/zinc superoxide dismutases using oligonucleotide primers. Patent Application Number: 09727645.5, GB Patent Number: 2268661, Granted on dated, 08/11/2017.

Bhardwaj, P.K, Kumar, A., Kishore, A., Ghawana, S., Rani, A., Singh, K., Singh, H., Singh R.S., Kumar H., Sood, P., Dutt, S., Kumar, S., Ahuja, P.S. (2017) A method for cloning functional gene of copper/zinc superoxide dismutases using oligonucleotide primers. Patent Application Number: 09727645.5, EP Patent Number: 2268661, Granted on dated, 08/11/2017.

Thakur, R., Sood, A., Ahuja, P.S. (2018) A bioreactor vessel for large scale growing of plants under aseptic conditions. Patent Application Number: 14/415711, US Patent Number: 9872448, Granted on dated, 23/01/2018.

## PUBLICATIONS

Adebisi, O., Dolma, S., Verma, PK., Singh, B., and Reddy, SGE. (2018) Volatile, non-volatile composition and insecticidal activity of *Eupatorium adenophorum* Spreng against diamondback moth, *Plutella xylostella* (L.) and aphid, *Aphis craccivora* Koch. *Toxin Reviews*, Doi:10.1080/15569543.2018.1434795.

Agrawal, H., Joshi, R., and Gupta, M. (2017) Isolation and characterisation of enzymatic hydrolysed peptides with antioxidant activities from green tender sorghum. *LWT-Food Science and Technology*, **84**, pp.608-616.

Ahmad, M., Uniyal SK., and Singh, RD. (2018) Patterns of alien plant species richness across gradients of altitude: analyses from the Himalayan state of Himachal Pradesh. *Tropical Ecology* **59**(1), pp. 35-43.

Arya, P., and Acharya, V. (2017) Plant STAND P-loop NTPases: A current perspective of genome distribution, evolution, and function. *Molecular Genetics and Genomics*, Doi.org/10.1007/s00438-017-1368-3.

Bala, M., Kumar, S., Pratap, K., Verma, PK., Padwad, Y., and Singh, B. (2017) Bioactive isoquinoline alkaloids from *Cissampelospareira*. *Natural product research*, pp.1-6. Doi: 10.1080/14786419.2017.1402319.

Banerjee, A., Devi, M., Nag, A., Sharma, RK., and Kumar, A. (2017) Modelling probable distribution of *Podophyllumhexandrum* in north-western Himalaya. *Indian Forester*, **143**(12), pp.1255-1259.

Bhandawat, A., Singh, G., Seth, R., Singh, P., and Sharma, RK. (2017) Genome-wide transcriptional profiling to elucidate key candidates involved in bud burst and rattling growth in a subtropical bamboo (*Dendrocalamushamiltonii*). *Front.PlantSci.*, **7**, pp.2038, Doi: 10.3389/fpls.2016.02038.

Bharti, R., Reddy, CB., and Das, P.(2017) Oxalic acid as sustainable CO source for pyrrolone-fused benzosuberones synthesis through palladium catalyzed carbonylative cyclization. *Chemistry Select*, **2**, pp.4626-4629.

Bhatt, V., Sharma, S., Kumar, N., Sharma, U., and Singh, B. (2017) Chemical composition of essential oil among seven populations of *Zanthoxylumarmatum* from Himachal Pradesh: Chemotypic and seasonal variation. *Natural Product Communications*, **12**, pp.1643.

Bhattacharjee, D., Thakur, V. Sharma, S., Kumar, S., Bharti, R., Reddy, C.B., and Das P. (2017) Iodine(III)promotedringcontractivecyanationofexocyclic $\beta$ -enaminones to cyanocyclopentanone synthesis. *Adv. Synth. Catal.*, **359**, 2209–2214.

Bhattacharjee, D., Thakur, V., Shil, A. K., and Das, P., (2017) Hypervalent iodine promoted aromatization of exo-cyclic  $\beta$ -enaminones for the synthesis of meta- N,N-diarylaminophenols. *Adv. Synth. Catal.*, **359**, pp.2202 –2208.

Chand, G., Meena, RL., Maurya, AK., Agnihotri, VK., and Singh, RD. (2017) Effect of growth hormones on seed germination and plant growth: with chemical components of *Hedychiumpicatum* Ham.ex.Smith. *Ornamental and Medicinal Plants*, **1**(1), pp.1-14.

Chandel, M., Kumar, M., Sharma, U., Singh, B., and Kaur, S. (2017) Antioxidant, Antigenotoxic and cytotoxic activity of *Anthocephalus cadamba* (Roxb.) Miq. bark fractions and their phytochemical analysis using UPLC-ESI-QTOF-MS. *Combinatorial Chemistry & High Throughput Screening*, **20**(9), pp. 760-772.

Chaudhary, A., Choudhary, S., Sharma, U., Vig, A.P., Singh, B., and Arora, S. (2018) Purple Head Broccoli (*Brassica oleracea* L. var. italica Plenck) A functional food crop for antioxidant and anticancer potential. *Journal of Food Science and Technology*, **55**, pp.1806.

Dadwal, V, Bhatt, S., Sonkhla, K., Robin, J., and Gupta, M. (2017) Quantification of free and bound phenolics in bio-waste pomegranate peel and formulation of punicalagin rich rice extruded snacks. *International Journal of Food and Nutrition Science*, **4(2)**, pp.98-104.

Dadwal, V., Agrawal, H., Sonkhla, K., Joshi, R. and Gupta, M. (2018) Characterization of phenolics, amino acids, fatty acids and antioxidant activity in pulp and seeds of high altitude Himalayan crab apple fruits (*Malus baccata*). *Journal of Food Science and Technology*, **55(6)** pp.2160-2169.

Dhiman, A.K., Kumar, R., Kumar, R., and Sharma, U. (2017) Metal-free synthesis of 2-substituted-3-(2-hydroxyaryl)quinolines and 4-(2-hydroxyaryl)acridines via benzyne chemistry. *The Journal of Organic Chemistry*, **82**, pp.12307.

Dolma, S., Sharma, E., Gulati, A., and Reddy, SGE. (2017) Insecticidal activities of tea saponin against diamondback moth, *Plutellaxylostella* and aphid. *Aphis craccivora* Toxin reviews, Doi: 10.1080/15569543.2017.1318405.

Gangwar, I., Sharma, N.K., Panzade, G., Awasthi, S., Agrawal, A., and Shankar, R. (2017) Detecting the molecular system signatures of idiopathic pulmonary fibrosis through integrated genomic analysis. *Scientific Reports*, Doi:10.1038/s41598-017-01765-6.

Gautam, M., Acharya, D., Bhat, Z.A., and Kumar, D. (2017) Future Leads: Natural products as anti-infective agent. *The Natural Products Journal*, **7(2)**, pp.84-96.

Goel, P., Sharma, N.K., Bhuria, M., Sharma, V., Chauhan, R., Pathania, S., Swarnkar, M.K., Chawla, V., Acharya, V., Shankar, R., and Singh, A.K. (2018) Transcriptome and co-expression network analyses identify key genes regulating nitrogen use efficiency in *Brassica juncea* L. *Scientific Reports*, DOI:10.1038/s41598-018-25826-6.

Hallan, V., Singh, R.M., and Singh, D. (2017) Movement protein of Apple chlorotic leaf spot virus is genetically unstable and negatively regulated by Ribonuclease E in *E. coli*. *Scientific reports*, Doi:10.1038/s41598-017-02375-y.

Koundal, R., and Agnihotri, V.K. (2017) Separation and identification of volatiles extracted by normal cleverger hydrodistillation and hydrodistillation adsorption apparatus from *Murraya koenigii* (L.) spreng leaves. *Indian Perfumer*, **61(1)**, pp.47-51.

Kumar, A., Bhardwaj, A., Chand, G., Agnihotri, V.K., and Reddy, SGE. (2016) Insecticidal activity of plant extracts of *Costusspeciosus* against diamond back moth, *Plutellaxylostella*. *Current Biotica*, **10(2)**, pp.144-148,

Kumar, A., Chand, G., and Agnihotri, V.K. (2017) A New Oxo-sterol derivative from the rhizomes of *costus speciosus*. *Natural Product Research*, Doi:10.1080/14786419.2017.1324962.

Kumar, D., and Sharma, U. (2018) High-performance thin-layer chromatography: An economical alternative for the quality control of medicinal plants and derived products. *Separation Science Plus*, Doi: 10.1002/sscp.201700013.

Kumar, D., Kumar, P., and Sharma, U. (2018) UPLC-DAD-MS based quality control and discrimination analysis of different aerial parts of *Crataegus rhipidophylla* Gand. found in Indian

western Himalaya. Analytical Chemistry Letters, **8**, pp.177.

Kumar, G., Gupta, K., Pathania, S., Swarnkar, MK., Rattan, UK., Singh, G., Sharma, RK., and Singh, AK. (2017) Chilling affects phytohormone and post-embryonic development pathways during bud break and fruit set in apple (*Malus domestica Borkh.*). Scientific Reports, **7**, pp.42593, Doi: 10.1038/srep42593.

Kumar, M., Bhatt, V., Nayal, OS., Sharma, S., Kumar, V., Thakur, MS., Kumar, N., Bal, B., Singh, B., and Sharma, U. (2017) CuI nanoparticles as a recyclable heterogeneous catalyst for C-N bond formation reactions. Catalysis Science & Technology, **7**, pp.2857.

Kumar, M., Sharma, S., Thakur, K., Nayal, OS., Bhatt, V., Thakur, MS., Kumar, N., Singh, B., and Sharma, U. (2017) Montmorillonite K10 catalyzed microwave assisted direct amidation of unactivated carboxylic acids with amines: Applicable for maintaining chiral integrity of substrates. Asian Journal of Organic Chemistry, **6**, pp.342-346.

Kumar, M., Thakur, K., Sharma, S., Nayal, OS., Kumar, N., Singh, B., and Sharma, U. (2017) Solvent-free, L-leucine catalyzed direct dehydrative esterification of carboxylic acids with alcohols: Direct synthesis of 3-alkoxy 1(3H)-isobenzofuranone Asian. Journal of Organic Chemistry, **7(1)**, pp. 227-231.

Kumar, R., Sharma, S., Sood, S., Kaundal, M., and Agnihotri, VK. (2017) Effect of manures and inorganic fertilizers on growth, yield, essential oil of damask rose (*Rosa damascena Mill.*) and chemical properties of soil in western Himalayas. Journal of Plant Nutrition, **40(11)**, pp.1604-1615, Doi: 10.1080/01904167.2016.1270315.

Kumar, R., Acharya, V., Singh, D., and Kumar, S. (2018) Strategies for high-altitude adaptation revealed from high quality draft genome of non-violacein producing *Janthinobacterium lividum* ERGS5:01. Standards in Genomic Sciences, **13(11)**, DOI: 10.1186/s40793-018-0313-3.

Kumar, R., Acharya, V., Mukhia, S., Singh, D., and Kumar, S. (2018) Complete genome sequence of *Pseudomonas frederiksbergensis* ERDD5:01 revealed genetic bases for survivability at high altitude ecosystem and bioprospection potential. Genomics, Doi.org/10.1016/j.ygeno.2018.03.008.

Kumar, R., and Kumari, M. (2018) Adaptive mechanisms of medicinal plants along altitude gradient: Contribution of proteomics. Biologia Plantarum, Doi.org/10.1007/s10535-018-0817-0.

Kumar, S., Patial, V., Soni, S., Sharma, S., Pratap, K., Kumar, D., and Padwad, Y. (2017) Picrorhiza kurroa enhances  $\beta$ -cell mass proliferation and insulin secretion in streptozotocin evoked  $\beta$ -cell damage in rats. Frontiers in Pharmacology. doi: 10.3389/fphar.2017.00537

Kumar, S., Subbarao, BL., Kumari, R., and Hallan, V. (2017) Molecular characterization of a novel cryptic virus infecting pigeonpea plants. PLoS ONE, **12(8)**, e0181829.

Kumar, S., Subbarao, BL., Kumari, R., and Hallan, V. (2017) Molecular characterization of emaraviruses associated with Pigeonpea sterility mosaic disease. Scientific Reports, Doi:10.1038/s41598-017-11958-8.

Kumar, A., Bhardwaj, A., Agnihotri, VK., Chand, G., and Reddy, SGE. (2017) Insecticidal activity of plant extracts of *Costus speciosus* against diamond back moth, *Plutella xylostella*. *Current Biotica*, **10(2)**, pp.144-148.

Kumar, A., Chand, G., and Agnihotri, VK. (2017) A new oxo-sterol derivative from the rhizomes of *Costus speciosus*. *Natural Product research*, Doi.org/10.1080/14786419.2017.1324962.

Kumar, A., Maurya, AK., Chand, G., and Agnihotri, VK. (2017) Comparative metabolic profiling of *Costus speciosus* leaves and rhizomes using NMR, GC-MS and UPLC/ESI-MS/MS. *Natural Product Research*, Doi:10.1080/14786419.2017.1365069).

Kumari, R., Abhishek, V., and Gupta, M. (2018) Nutritional, functional and textural properties of healthy snacks formulation from hulled and hull-less barley. *Journal of Food Measurement and Characterization*, **12(2)**, pp.1219-1228.

Maurya, AK., Meena, RL., Kumar, A., Prasad, R., and Chand, G. (2017) Current status of *Valeriana jatamansi* an endangered species. *Global J Res. Med. Plants & Indigen. Med.*, **6(7)**, pp.95–102.

Maurya, SK., and Rana, R. (2017) An eco-compatible strategy for the diversity-oriented synthesis of macrocycles exploiting carbohydrate-derived building blocks. *Beilstein J. Org. Chemistry*, **13**, pp.1106-1118.

Mazumder, AG., Sharma, P., Patial, V., and Singh, D (2017) Crocin attenuates kindling development and its associated cognitive impairments in mice via inhibiting reactive oxygen species-mediated NF- $\kappa$ B activation. *Basic & Clinical Pharmacology & Toxicology*, **120**, pp.426-433.

Mazumder, AG., Sharma, P., Patial, V., and Singh, D (2017) Ginkgo biloba L. attenuates spontaneous recurrent seizures and associated neurological conditions in lithium-pilocarpine rat model of temporal lobe epilepsy through inhibition of mammalian target of rapamycin pathway hyperactivation. *Journal of Ethnopharmacology*, Doi: 0.1016/j.jep.2017.03.060.

Nayal, OS., Thakur, M. S., Kumar, M., Kumar, N., and Maurya S. K. (2017) Ligand-free iron(II)-catalyzed N-alkylation of hindered secondary arylamines with non-activated secondary and primary alcohols via a carbocationic pathway. *Adv. Synth. Catal.*, Doi: 10.1002/adsc.201701183.

Nayal, OS., Thakur, MS., Kumar, M., Shaifali, Upadhyay, R., and Maurya, SK. (2017) Green and efficient CuI NPs catalytic cross-coupling approach for the synthesis of tertiary-3-aminopropenoates, ciprofloxacin and triazoles. *Asian Journal of Organic Chemistry*, Doi.org/10.1002/ajoc.201700682.

वालिया, स्वाति एवं कुमार, राकेश (2017) ऊँचे पर्वतीय क्षेत्रों महत्वपूर्ण औषधीय पौधा—जिनसेंग! विज्ञान प्रगति, **65(11)**, pp.20-24.

Pal, P.K. and Mahajan, M. (2017) Pruning system and foliar application of MgSO<sub>4</sub> alter yield and secondary metabolite profile of *rosadamasцена* under rainfed acidic conditions. *Front. Plant Sci.*, **8**, pp.507. doi: 10.3389/fpls.2017.00507.

Pal, PK., and Mahajan, M. (2017) Tillage system and organic mulch influence leaf biomass, steviol glycoside yield and soil health under sub-temperate conditions. *Industrial Crops & Products*, **104**, pp.33–44.

Patial, V., Sharma, S., and Hossain, SK, U. (2017) Dendrimer conjugated estramustine nanocrystalline ‘Dendot’: An effective inhibitor of DMBA-TPA induced papilloma formation in mouse. *European Journal of Pharmaceutical Sciences*, **109**, pp.316-323.

Purohit, R., Kumar, S., and Hallan, V. (2018) Screening of potential inhibitor against coat protein of apple chlorotic leaf spot virus. *Cell Biochem. Biophys.*, Doi.org/10.1007/s12013-017-0836-z.

Purohit, R., Kumar, S., and Hallan, V. (2017) Screening of potential inhibitor against coat protein of Apple chlorotic leaf spot virus. *Cell Biochemistry and Biophysics*, Doi: 10.1007/s12013-017-0836-z.

Rattan, R., Fozdar, BI., Gautam, V., Sharma, R., Kumar, D., and Sharma, U. (2017) Cuspidate A, New anti-fungal triterpenoid saponin from *Lepidagathis cuspidate*. *Natural Product Research*, **31(7)**, pp.773-779.

Reddy, C.B., Bharti, R., Kumar, S., and Das, P. (2017) Supported palladium nanoparticle catalyzed  $\alpha$ -alkylation of ketones using alcohols as alkylating agents. *ACS Sustainable Chem. Eng.*, **5(11)**, pp.9683–9691

Reddy, SGE., and Dolma, S. (2018) Acaricidal activities of essential oils against two spotted spider mite, *Tetranychusurticae* Koch. *Toxin Reviews*, **37(1)**, pp.62-66.

Reddy, SGE., Dolma, S., Verma, PK., and Singh, B. (2017) Insecticidal activities of *Parthenium hysterophorus* L. extract and parthenin against diamondback moth, *Plutella xylostella* (L.) and aphid, *Aphis craccivora* Koch *Toxin reviews* Doi:10.1080/15569543.2017.1339281.

Roshan, R.,Kulshreshtha, A., Kumar, S., Purohit, R., and Hallan, V. (2018) AV2 protein of tomato leaf curl Palampur virus promotes systemic necrosis in *Nicotianabenthamiana* and interacts with host Catalase2. *Scientific Reports*, Doi:10.1038/s41598-018-19292-3.

Sharma S., Sharma, P., Kulurkar, P., Singh, D., Kumar, D., and Patial, V. (2017) Iridoid glycosides fraction from *Picrorhiza kurroa* attenuates cyclophosphamide-induced renal toxicity and peripheral neuropathy via PPAR- $\gamma$  mediated inhibition of inflammation and apoptosis. *Phytomedicine*, **36**, pp108-117.

Sharma, A., Sharma, R., Arora, R., Arora, S., Singh, B., and Sharma, U. (2017) Quantitative and qualitative analysis of *Eruca sativa* and *Brassica juncea* seeds by UPLC-DAD and UPLC-ESI-QTOF. *Natural Product Communications*, **12**, pp.1485.

Sharma, E., Joshi, R., and Gulati, A. (2018) L-Theanine: An astounding sui generis integrant in tea. *Food Chemistry*, Doi: 10.1016/j.foodchem.2017.09.046.

Sharma, PK., Bansal, R., Bhardwaj, AK., Sood, V., Sood, A., and Padwad, Y. (2018) Plasma levels of Rifampicin and Pyrazinamide with pre and post meal administration in tuberculosis patients. *The Indian journal of tuberculosis*, **65(1)**, p.35.



Sharma, R., Jandroti, R., Singh, B., Sharma, U., and Kumar, D. (2018) Comprehensive metabolomics study of traditionally important Rumex species found in Western Himalayan region. *Natural Product Communication*, **13**, pp.189-194.

Sharma, R., Kumar, I., Kumar, R., and Sharma, U. (2017) Rhodium-Catalyzed Remote (C-8) alkylation of quinolines with activated and unactivated Olefins: Mechanistic study and total synthesis of EP4 Agonist. *Advanced Synthesis & Catalysis*, **359**, pp.3022.

Sharma, R., Sharma, A., Kumari, A., Kulurkar, PM., Raj, R., Gulati, A., and Padwad, Y. (2017) Consumption of green tea epigallocatechin-3-gallate enhances systemic immune response, antioxidative capacity and HPA axis functions in aged male swiss albino mice. *Biogerontology*, **18(3)**, pp.367-382.

Sharma, S., and Kumar, R. (2018) Influence of harvesting stage and distillation time of damask rose (*Rosa damascena Mill.*) flowers on essential oil content and composition under Western Himalayas. *Journal of Essential Oil Bearing plants*, **21(1)**, pp. 92-102.

Sharma, S., Bhattacharjee, D., and Das, P. (2018) Oxalic/malonic acids as carbon building blocks for benzazole, quinazoline and quinazolinonesynthesis. *Org. Biomol. Chem.*, Doi.org/10.1039/C7OB03064A.

Sharma, S., Pathare, RS., Sukanya, Maurya, AK., Goswami, B., Agnihotri, VK., Devesh, M., Sawant, and Pardasani, RT. (2017) Microwave assisted metal-/oxidant-free cascade electrophilic sulfenylation/ 5-endo-dig cyclization of 2-alkynylanilines to generate diversified 3-sulfenylindoles. *Tetrahedron Letters*, **58**, pp.3823-3826, DOI: 10.1016/j.tetlet.2017.08.046.

Singh, A., Vats, SK., and Kumar, S. (2017) The present trend of research and developmental activities taking over by global mountain organizations. *Octa Journal of Environmental Research*, **5(4)**, pp.258-269.

Singh, G., Singh, G., Singh, P., Parmar, R., Paul, N., Vashist, R., Swarnkar, M.K., Kumar, A., Singh, S., Singh, A.K., Kumar, S., and Sharma, R.K. (2017) Molecular dissection of transcriptional reprogramming of steviol glycosides synthesis in leaf tissue during developmental phase transitions in *Stevia rebaudiana Bert.* *Scientific Reports*, **7**, pp.11835, Doi:10.1038/s41598-017-12025-y.

Singh, P., Singh, G., Bhandawat, A., Singh, G., Parmar, R., Seth, R., and Sharma, RK. (2017) Spatial transcriptome analysis provides insights of key gene(s) involved in steroidal saponin biosynthesis in medicinally important herb *Trillium govanianum*. *Scientific Reports*, **7**, pp.45295, Doi: 10.1038/srep45295.

Singh, RM., Singh, D., and Hallan, V. (2017) Movement protein of Apple chlorotic leaf spot virus is genetically unstable and negatively regulated by Ribonuclease E in *E. coli*. *Scientific Reports*, **7**, pp.2133, Doi:10.1038/s41598-017-02375-y.

Singh, S., Raja, R. Kaundal, S., Sharma, A., Kumar, A., and Dhyani, D. (2016) Field performance and differential response of micro-propagated potential F1 genotypes of *Gerbera jamesonii*. *American Journal of Experimental Agriculture*, **10(1)**, pp.1-11.

Singh, S. (2018) Economic feasibility of some important tissue culture produced plants in himachal pradesh. agricultural situation in India, **46(10)**, pp34-40.

Singh, S., Singh, D., and Kumar, S. (2017) Expression and bio chemical analysis of codon-optimized polyphenol oxidase from *Camellia sinensis* (L.) O. Kuntze in *E. coli*. Process Biochemistry, Doi.org/10.1016/j.procbio.2017.05.008.

Singh, V., Singh, B., Sharma, A., Kaur, K., Gupta, AP., Salar, RK., Hallan, V., and Pati, PK. (2017) Leaf spot disease adversely affects human health-promoting constituents and withanolide biosynthesis in *Withaniasomnifera* (L.) Dunal. Journal of Applied Microbiology, **122**, pp.153–165, Doi:10.1111/jam.13314.

Singh, V., Kumar, M., and Singh, H. (2017) Competitive interactions between rice and *Caesulia axillaris* or *Echinochloa crus-galli*: A replacement series study. Annals of Agricultural & Crop Sciences, **2(1)**, pp.1025.

Singla, R., Soni, S., Padwad, Y., Acharya, A., and Yadav, S. (2017) Sustained delivery of BSA/HSA from biocompatible plant cellulose nanocrystals for in vitro cholesterol release from endothelial cells. Int. J. Biol. Macromolec, **104**, pp.748.

Singla, R., Soni, S., Patial, V., Kulurkar, P., Kumari, A., Mahesh, S., Padwad, Y., and Yadav S. (2017) Cytocompatible Anti-microbial Dressings of *Syzygiumcumini* cellulose nanocrystals decorated with silver nanoparticles accelerate acute and diabetic wound healing. Scientific Reports-Nature. **7(1)**, pp.10457

Singla, R., Soni, S., Patial, V., Kulurkar, P., Kumari, A., Mahesh, S., Padwad, Y., and Yadav, S. (2017) In vivo diabetic wound healing potential of nanobiocomposites containing bamboo cellulose nanocrystals impregnated with silver nanoparticles. International Journal of Biological Macromolecules, Doi.org/10.1016/j.ijbiomac.2017.06.109.

Soni, S., and Padwad, Y. (2017) HIF-1 in cancer therapy: two decade long story of a transcription factor. Acta Oncologica, **56(4)**, pp.503-515.

Stappen, I., Tabanca, N., Ali, A., Wedge, DE., Wanner, J., Gochev, V., Jaitak, V., Lal, B., Kaul, VK., Schmidt, E., and Jirovetz, L. (2017) Biological activity of buniumpersicum essential oil from western Himalaya. Planta med int open, **4**, pp.52–58.

Thakur, D., Rathore, N., Sharma, M.K., and Chawla, A. (2018) Enhanced reproductive success revealed key strategy for persistence of devastated populations in Himalayan food deceptive orchid, *Dactylorhiza hatagirea*. Plant Species Biology, Doi: 10.1111/1442-1984.12205.

Thakur, D., Sharma, A., and Uniyal, SK. (2017) Why they eat, what they eat: patterns of wild edible plants consumption in a tribal area of Western Himalaya. Journal of Ethnobiology and Ethnomedicine, **13(70)**, Doi:10.1186/s13002-017-0198-z.

Thakur, M., and Kumar, R. (2018) Agro-meteorological indices, heat use efficiency and yield of aromatic rose (*Rosa damascena* Mill.) varieties as influenced by pruning time in the western Himalayas. Journal of Agrometeorology, **20(1)**, pp 31-35.

Thakur, MS., Nayal, OS., Rana, R., Kumar, M., Sharma, S., Kumar, N., and Maurya, SK. (2018) Unravelling 2-aminoquinazolin-4(3H)-one as an organocatalyst for the chemoselective reduction of nitroarenes. *New Journal of Chemistry*, **42**, pp.1373 - 1378.

Thakur, V., Kumar, A., Sharma, N., Shil, A. K., and Das, P., (2017) Supported palladium nanoparticles catalyzed reductive carbonylation of nitroarenes to N-arylformamides. *Adv. Synth. Catal.*, **359**, pp.1–7

Thakur, V., Kumar, S., and Das P. (2017) Polystyrene supported palladium nanoparticles catalyzed cinnamic acid synthesis using maleic anhydride as a substitute for acrylic acid. *Catal. Sci. Technol.*, **7**, pp.3692-3697

Uniyal, SK. (2017) Classifying medicinal plant collectors: their approach and attitude. *Current Science*, **113(11)**, pp.2085-2089.

Uniyal, SK., Jaryan, V., and Singh, RD. (2017) Digital images for plant phenology documentation. *National Academy Science Letters*. **40(2)**, pp.135-139. Doi:10.1007/s40009-016-0517-2.

Verma, SK., Sharma, A., Sandhu, P., Choudhary, N., Sharma, S., Acharya, V., and Akhter, Y. (2017) Proteome scale identification, classification and structural analysis of iron-binding proteins in bread wheat. *Journal of Inorganic Biochemistry*, pp.63-74.

Walia, S., and Kumar, R. (2017) Development of the nondestructive leaf area estimation model for *Valeriana (Valeriana jatamansi Jones)*. *Communications in Soil Science and Plant Analysis*, **48(1)**, pp.83–91.

Walia, S., Guliani, A., and Acharya, A. (2017) A Theragnosis probe based on BSA/HSA-conjugated biocompatible fluorescent silicon nanomaterials for simultaneous in vitro cholesterol effluxing and cellular imaging of macrophage cells. *ACS Sustainable Chem. Eng.*, **5**, pp.1425.

## **BOOK(S)/ BOOK CHAPTERS**

Pal, PK., Singh, S., and Sud, RK. (2017) *Advances in weed management in tea. Weed Control. Sustainability, Hazards and Risks in Cropping Systems Worldwide.* CRC press, Taylor and Francis Group.

Dubey N., Singh K. (2018) Role of NBS-LRR proteins in plant defense. *Molecular Aspects of Plant-Pathogen Interaction.* (Eds. Singh A., Singh I.) Springer, Singapore.

Dhiman, N., Gautam, N., Sareen, B., Kumari, P., Rajouria, S., and Bhattacharya, A. (2018) *In Vitro* Morphogenesis of Some Himalayan Flora Using TDZ: A Potential Plant Growth Regulator. *Thidiazuron: From Urea Derivative to Plant Growth Regulator* (Eds. Ahmad N, Faisal M), Springer, Singapore, pp. 247-271.

Thapa, P., Bhattacharya, A., Sood, P., Devi, K., & Sood, A. (2018) *Advances in Bamboo Biotechnology: Present Status and Future Perspective.* *Biotechnologies of Crop Improvement* (Eds. Gosal S.S. and Wani S.H), Volume 1, Springer, pp. 243-265.

Lal, B. and Omprakash (2017) *Trek and learn: Plants at CSIR-IHBT Campus.* India, pp. 1-154.

## ABSTRACTS

Thakur, D., and Chawla, A. (2018) Predicting the climate change effects on high altitude vegetation from plant functional traits. In: Abstracts Volume of 2nd International Workshop on Biodiversity and Climate Change, Indian Institute of Technology Kharagpur, India, pp.04.

Singh, L., Thakur, D., Sharma, M.K., and Chawla, A. (2018) Dynamics of plant litter decomposition in the treeline ecotones of western Himalaya. In: Abstracts Volume of 2nd International Workshop on Biodiversity and Climate Change, Indian Institute of Technology Kharagpur, India, pp.80.

Sharma, L.K., Rana, R.K., Singh, A. and Singh, V. (2017) Mass multiplication and plantation of Sea buckthorn in the cold desert condition of Himachal Pradesh. In: National Conference on Sea buckthorn: Improving health and Sustainable Development of Himalayan Region. p89.

Singh, S., Singh, A., Kumar, R., Sharma, R.K., Kumar, D., and Kumar, S. (2017) Comprehensive agro-biotechnological efforts for genetic improvement and conservation of Seabuckthorn (*Hippophae L.*). In: Improving health and Sustainable Development of Himalayan Region. p.94.

Singh, A., Kumar, R., Singh, S., Lal, B., Chawla, A., Chand, G., Devi, K., Bharghav, B., Ogra, R.K., Singh, M., Sud, R.K., Sood, A., Ahuja, P.S., and Kumar, S. (2018) Ex-situ Conservation of high altitude threatened plant resources of western Himalaya. IN: National Conference on Ethnobotany and Traditional knowledge in Biodiversity Conservation. Organized by the Baba Gulam Shah Bradshaw University Rajouri, Jammu & Kashmir.

## THESIS/DISSERTATION/REPORT/SUPERVISED

### Ph. D.

Bhatt Vinod (2018) Phytochemical and synergy-directed biological studies of *Zanthoxylum* species. Supervised by Dr. Bikram Singh; Co-Guide: Dr. Upendra Sharma.

Sharma Saurabh (2017) Effect of mulching and growth regulating factors on growth, yield and quality of *Stevia Rebaudiana* Bertoni in the Western Himalayas. Supervised by Dr. Rakesh Kumar.

Patial Vanita (2017) Micropropagation & over-expression of PkSWRKY transcription factor in *Picrorhiza kurroa*. Supervised by Dr. Amita Bhattacharya.

Gangwar Indu (2017) In silico analysis of biomolecular interactions involved in system regulation using high throughput approach. Supervised by Dr. Ravi Shankar.

## TRAININGS IMPARTED

Aabid Hussain Pandith (Feb–June, 2017) Isolation and characterization of protein- nanoparticle complex. Baba Ghulamshah Badshah University, Rajouri, J\$ K, Supervised by Dr. Amitabha Acharya.

Amit (2017) Phytochemical investigation of *Cissampelos pareira*, Amity University Gurgaon, Haryana, Under Supervised by Dr. Upendra Sharma.

Anjali Sharma (2017) Learning tools and techniques of remote sensing and geographic information system for studying temporal changes in built-up areas in-and-around Palampur, Himachal Pradesh. Gautam Buddha University, Greater Noida, Uttar Pradesh, Supervised by Er. Amit Kumar.

Diksha Choudhary (2017) Investigating monoamine oxidase inhibitory activity of the given molecules. DAV College Chandigarh, Supervised by Dr. Damanpreet Singh.

Ishita Sood (2017) To study the effect of IHBT-DKN-01 in isoproterenol induced acute myocardial infarction. DAV College Chandigarh, Supervised by Dr. Damanpreet Singh.

Garvit Sharma (Dec, 2017-Jan, 2018) Exposure to nanotechnological facilities and nanomaterials characterization, SRM University, Supervised by Dr. Amitabha Acharya.

Kurangi (June – July, 2017) Synthesis and characterization of noble metal nanoparticles. Sri Guru Granth sahib World University, Supervised by Dr. Amitabha Acharya.

Priyanaka Langeh (Feb – June, 2017) Nano-emulsion of essential oil and their antimicrobial efficacy studies. Baba Ghulamshah Badshah University, Rajouri, J&K, Supervised by Dr. Amitabha Acharya.

Reetu Bala (2017) Lewis acid catalyzed N-alkylation of 1,2,3,4-tetrahydroisoquinolines with acrylates. SGGS College, Punjab University, Chandigarh, Supervised by Dr. Upendra Sharma.

Sachin (2017) Synthesis of quinoline N-Oxides and quinoline Ylides, Amity University Gurgaon, Haryana, Supervised by Dr. Upendra Sharma.

Saurabh Kumar (2017) Fractionation and isolation of secondary metabolites from *Cissampelos pareira*. SHUATS, Allahabad, Supervised by Dr. Upendra Sharma.

Sharddha Patel (2017) Leaf and litter nutrient dynamics of temperate forest at Dhauladhar wildlife sanctuary. Amity University, Rajasthan, Supervised by Dr. Manoj Kumar.

Shreya Gupta (2018) Enrolled at Amity University, Noida completed her training for B.Sc. Medical Biotechnology, Supervised by Dr. Damanpreet Singh.

Snehil Kapoor (2018) Enrolled at Amity University, Noida completed his training for M.Sc. Biotechnology, Supervised by Dr. Damanpreet Singh.

Vishal Verma (June – July, 2017) Synthesis and characterization of metallic nanoparticles. Sri Guru Granth sahib World University, Supervised by Dr. Amitabha Acharya.

Madeha Parveen (2018) Euclidean distance based alignment free sequence comparison. Jammu University, J&K, Supervised by Dr. Ravi Shankar.

Jaspreet Kour (2018) Inferring RBP-mediated miRNA regulation in thyroid cancer. Jammu University, J&K, Supervised by Dr. Ravi Shankar.

Tabasum-un-nissa (2018) Identification of DNA methylated genes in *Glycine max*. Jammu University, J&K, Supervised by Dr. Ravi Shankar.

Syed- Mohsin- Aleem (2018) Analysis of epigenetic and sRNA mediated regulation in *Zea mays*, with network visualization. Jammu University, J&K, Supervised by Dr. Ravi Shankar.

Anweysha Bhowmik (2017) Gene Expression profiling in Idiopathic Pulmonary Fibrosis using RNA Sequencing. HIT, Kolkata, Supervised by Dr. Ravi Shankar.

### **CONFERENCE/TRAINING/WORKSHOP/SYMPOSIUM PRESENTATIONS**

Rana, D., Bhatt, A., and Lal, B. (2017) Observation on socio-economic and cultural aspects of native people of Pangi valley of Chamba district, Himachal Pradesh. 2nd Himachal Science Congress. Shimla, November 20-21.

Lal, B. and Kumari, A. (2018) Conserving fern diversity of western Himalaya. National Conference on Climate Change, Environmental Pollution and Biodiversity Conservation organized, NBRI, Lucknow, February 24-25.

Rana, D., Bhatt, A., and Lal, B. (2018) Studies on lifestyle and livelihood options of the gujjar tribe of Tissa region of District Chamba, Himachal Pradesh in the Western Himalaya. National Seminar on "Ethnobotany and Traditional knowledge in Biodiversity Conservation", BGSB University, Rajouri, J&K, March 8-9.

### **CONFERENCE/TRAINING/WORKSHOP/MEETING ATTENDED**

Singh, D. (2017) Attended nano based therapy for neurodegenerative diseases organized by National Institute of Pharmaceutical Sciences and Drug Research (NIPER), Raebareli, March 27-28.

Kumar, A. (2017) Attended a meeting on development of framework for a long term ecological monitoring (LTEM) system in Himachal Pradesh, Shimla, April 27.

Lal, B. (2017) '2<sup>nd</sup> National Dialogue on Traditional Knowledge (TK) and Access and Benefit Sharing (ABS)' for strengthening the implementation of Biological Diversity Act and Rules with focus on its Access & Benefit Sharing Provisions, Shimla, May 1-3.

Singh, D. (2017) Attended, IMTechCon 2017 an "Industry-Academia Meet" organized by CSIR-Institute of Microbial Technology. Chandigarh, June 4-6.

Kumar, M. (2017) Meeting and discussion with Dr. P. Goswami, Director, CSIR-NISTADS, New Delhi for developing joint project proposal related to vulnerability assessment through model during their visit at CSIR-IHBT, Palampur, June 13-16.

Lal, B. (2017) Participated in 'CSIR-Net Pre-Examination Meeting' as an expert in the subject of life Sciences. CSIR-HRDC, Ghaziabad, 30 June to 1 July.

Kumar, M. (2017) Meeting attended to develop a joint research proposal with two scientists Dr. Vipin Kumar and Dr. Madhulika Bhati, CSIR-NISTADS, New Delhi, their visit at CSIR-IHBT, Palampur, July 6-8.

Kumar, R., and Sharma, M. (2017) Attended Workshop on Bioenergy/biofuels workshop for CSIR laboratories and key stakeholder. CSIR- IICT Hyderabad, Telangana, August 29-30.

Kumar, R. (2017) Conference on Smart Agriculture for Sustainable, Inclusive Productivity. Tokyo, Japan, September 5-7.

Uniyal, SK., Kumar, A. and Chawla, A.(2017)Attended UNESCO, IMS and South Asian workshop on strengthening early warning for disaster risk reduction in Himalayan agriculture, CSKHPKV, Palampur, Himachal Pradesh, October 25-26.

Sud, RK (2017) Potential crops to boost farmers' income Bhawarna Block. BDO Office, Bhawarna. December 7.

Kumar, A. (2018)Attended 2<sup>nd</sup> PAMC meeting of Network Project on Imaging Spectroscopy & Applications (NISA), Department of Science & Technology, Govt. of India, Gandhi Institute of Technology and Management (GITAM) university, Bengaluru, Karnataka, January 5-6.

Singh, D. (2018) Attended a training programme on “Management of Scientific Research for Value Creation” organized by CSIR-HRDC, Gaziabad, January 17-19.

Singh, D. (2018) Attended “Workshop on imparting the knowledge on vigilance and Tendering Process” at CSIR-IHBT, February 13.

Kumar, R. (2018) Workshop attended on ‘Imparting the on vigilance and indenting processes. CSIR-IHBT, Palampur, February 13.

Sud, RK and Dhadwal, VS (2018) SKRP meeting, Tea Board of India, Palampur. February 15.

Uniyal, SK. (2018) Attended the State Biodiversity Action Plan Meeting. Shimla, February 19.

Chawla, A.(2018) Predicting climate change effects on high altitude vegetation from plant functional traits. International Workshop on Biodiversity and Climate Change (BDCC 2018) organised by Centre for Oceans, Rivers, Atmosphere and Land Sciences (CORAL), IIT Kharagpur, February 24- 27.

Chawla, A.(2018) Attended training programme on “Climate Change and Carbon Mitigation” for Scientists and Technologists working in Government Sector, ICFRE, Dehradun, February 19-23.

Kumar, M. (2018) Meeting attended with scientists of various CSIR labs through VC regarding the preparation of project proposal under theme Ecology, Environment and Earth Science and Water, 23 February.

Kumar, R. (2018) Attended Inter Ministerial Committee Meeting on Medicinal and Aromatic Plants for NER. Vigyan Bhawan, New Delhi, March 12.

Sud, RK and Singh, S (2018) 73rd Tea Research Liaison Committee (TRLIC) meeting, 22.03.2018, Tea Board, Kolkata and presented Progress Report of Tea Improvement and Tea Mechanization projects at Tea Board, Kolkata, March 19.

Kumar, M. (2018) Meeting attended with scientists of various CSIR labs through video conferencing (VC) regarding the preparation of project proposal under theme *Agri-Nutr-Biotech*, 07-26 March.

Chawla, A.(2018) Attended meeting on “Climate Change – Need for Adaptation in H.P.” Shimla, March 28.

Lal, B. (2018) Organized ‘*CSIR Net Pre-Examination Confidential Meeting in Physical Sciences*’ as Coordinator, CSIR-IHBT Palampur, March 29-31.

Lal, B. Provision for authentication of plants being studied by scientists and students of different organizations including CSIR-IHBT Palampur.

Lal, B. ‘*Project Approval Committee (PAC)*’ meeting , H.P. Council for Science, Technology & Environment (HIMCOSTE), Shimla.

### **ADVISORY VISITS TO DIFFERENT TEA GARDENS**

Sud, RK (2017) Kangra Valley Tea Estate, Sidhbari Tea Estate, Mann Tea Estate, Jhikkar Tea Estate, Pathiar Tea Estate and Chambi Tea Estate. July 28.

Sud, RK (2017) Raipur Tea Estate, Mansimbal Tea Estate, Khalate Tea Estate, Bhadal Devi Tea Estate, Thandol Tea Estate and Bhawarna Tea Estate. August 26.

Sud, RK (2018) Raja, Jogindernagar area. February 2.

Sud, RK (2018) Sullah Tea Estate, Bhadal Devi Tea Estate, Thandol Tea Estate. February 5.

Sud, RK (2018) Chauntra, Stain, Raja area, 35 Trainees. February 6.

Sud, RK (2018) Chambi Tea Estate, Nagri Tea Estate, Kaloond Tea Estate, Kangra Valley Tea Estate, 30 Trainees. February 7.

Sud, RK (2018) Along with Tea Board, Sullah, Saloh area. February 15.

Sud, RK (2018) Raipur Tea Estate, Mansimbal Tea Estate, Darang Tea Estate, Kangra Valley Tea Estate. February 16.

Sud, RK (2018) Advisory on machine plucking at Thandol Tea Estate, Sungal Tea Estate and Sullah Tea Estate. March 14.

Sud, RK (2018) Sungal Tea Estate, Khalate Tea Estate, Sullah Tea Estate, Darang Tea Estate area. March 16.

Sud, RK (2018) Raipur Tea Estate, Kangra Valley Tea Estate, Dharamshala Tea Estate. March 21.

### **REPORT SUBMITTED**

Sud, RK (2018) Report on ‘Revival plan of dilapidated tea plantation at CSIR-IIP, Dehradun, January 26.

Sud, RK (2018) Report on the project ‘Survey and mapping of Astavarga plants in Himachal Pradesh’. HFRI, Shimla, January 30.



## CONFERENCE/TRAINING/WORKSHOP/MEETING ORGANIZED

Sud, RK. (2018) Training on rehabilitation of lemongrass plantations, Una & Amb area. 25 farmers, CSIR-IHBT, Palampur, January 23.

Sud, RK. (2018) Training on tea farm mechanization to tea growers' of SHG. 30 growers, CSIR-IHBT, Palampur, January 24.

Sud, RK. (2018) Training on revival of dilapidated tea plantations to tea growers' of SHG. 30 growers, CSIR-IHBT, Palampur, January 25.

Sud, RK. (2018) Awareness on cultivation of medicinal and aromatic plants among the tea growers' SHG. 30 growers, CSIR-IHBT, Palampur, January 25.

Sud, RK. and Dhadwal, VS. (2018) Training programme for the staff of CSIR-IIP on revival of abandoned tea plantation & their management, CSIR-IHBT, Palampur, March 19-21.

Sud, RK. (2017) Workshop on "Kangra Tea Industry: Current status and future prospects, jointly organised with Tea Wing of State Agricultural Department", August 31.

Singh, A. (2017) Organized "Farmer and NPC expert meeting: On National Productivity Council" visited in the Lahaul valley to observe the work done by CSIR-IHBT for the upliftment of Floriculture cultivation in the valley, May 17-18.

Lal, B., Chawla, A., and Singh, A. (2017) Meeting organized for CSIR-IHBT CeHAB for looking the progress of Centre at High Altitude Biology, May 25.



Singh, A., Rana, RK., and Singh, S. (2017) Regarding assessment of project on "Sea-buckthorn (*Hippophae*)", a project assessment team of Department of Biotechnology, New Delhi visited to CSIR-IHBT CeHAB at Ribling, Lahaul-Spiti, July 21.

Rana, RK., Singh, A., and Singh, S. (2017) A training program was organized on "Cultivation of Medicinal & Aromatic plants and their value addition" for the farmers of Gaushal Panchayat, Lahaul-Spiti Technology, May 28.

Bhattacharya, Amita (2017) Advance training in Plant Tissue Culture. 7 trainees, CSIR-IHBT, Palampur, June 6-16.

Bhattacharya, Amita (2017) Plant Tissue Culture for Entrepreneurs. 1 trainee, CSIR-IHBT, Palampur, August 22 to September 1.

Warghat, Ashish (2018) Hand on training in plant tissue culture. 7 trainees, CSIR-IHBT, Palampur, July 9-18.

Singh, A. (2017) A Training program related to "Cultivation and Value addition of Medicinal & Aromatic plants" were organized for the farmers of Lahaul valley at our Centre CeHAB Ribling, Lahaul-Spiti in front of project assessment team member of Department of Science and Technology New Delhi, Participants 20, August 31.



Singh, A. (2017) Excursion cum Training related to "Topic Research and development Activities of CSIR-IHBT Palampur and CSIR-IHBT CeHAB Ribling Lahaul & Spiti" to the Students and Teachers of Government Senior Secondary School Malang, Lahaul-Spiti were conducted at CSIR-IHBT CeHAB Ribling, Lahaul-Spiti, Participants 36, October 27.



Singh, A. (2017) Organized training program and delivered a lecture: on "Field visit cum training program" at CeHAB farm Ribling to the Villagers of Tandi Panchayat Mahila Mandal, Participants 22, November 10-13.



### **Coordinated Exhibition**

Dr. Ashok Singh interacted with more than 600 people R&D exhibition on the occasion of "Tribal Fair Keylong Lahaul-Spiti (HP)", on dated 14-16 August 2017, Inaugurated by Honorable Chief guest Sh. Kaul Singh Thakur, IPH & Revenue Minister HP Govt. Shimla with Local MLA Sh. Ravi Thakur, Ex MLA cum chairman HP wool federation Sh. Raghubir Singh, DC Keylong.

Dr. Ashok Singh interacted with more than 200 people R&D exhibition on the occasion of "Ladarcha Tribal Fair Kaza, Spiti", on dated 17-19 August 2017, Inaugurated by local MLA Sh. Ravi Thakur, Ms. Shashi Kiran Vice Chairmen Jila Parishad Lahaul-Spiti, Sh. Vikram Singh ADC Kaza.

## INVITED LECTURES

Kumar, A. (2018) Role of academia in partnership with government and industry towards promoting geospatial education. IIRS User Interaction Meet- 2018, Indian Institute of Remote Sensing (IIRS), ISRO, Dehradun, Uttarakhand, February 27.

Kumar, R. (2017) Delivered a talk on important medicinal and aromatic plants. GAV Public School Saliana, Palampur, HP, May 19.

Kumar, R. (2017) Delivered a talk on Bio-energy initiative on CSIR-IHBT Palampur. Workshop on Bioenergy/biofuels for CSIR laboratories and Key stakeholder at CSIR- IICT Hyderabad, Telangana, August 29-30.

Kumar, R. (2018) Improved cultivation Techniques of Rose. Skill Development Programme on Cultivation, Primary Processing and Marketing of Economically Important Plants, suitable for NER under CSIR- Aroma Mission organized by CSIR-CIMAP at Nongstoin distt, West Khasi Hills, Meghalaya, March 27.

Kumar, M. (2017) Delivered an invited lecture in International conference on topic “*Himalaya ke Paristhikee Tantra Par Jalvayu Parivartan ka Prabhav* (हिमालय के पारिस्थितिकी तंत्र पर जलवायु परिवर्तन का दुष्प्रभाव)”. CSIR- Indian Institute of Toxicology Research, Lucknow, October 11.

Sharma, U. (2017) “Quinoline Functionalization through Remote C-H Activation Using Traceless Directing Group” in Contemporary Facets in Organic Chemistry Synthesis (CFOS). IIT Roorkee, Uttarakhand, December 22-24.

Sharma, U. (2017) “Medicinal Plant Processing: Novel Bioactive Molecules” in Scenario of Medicinal Plants in Himalayan Region-Cultivation, Processing and Marketing, CSIR-IHBT, Palampur, India. Organised by State Medicinal Plants Board, Himachal Pradesh, Ayurveda Bhawan, SDA Complex, Kasumpti, Shimla, October 10-11.

Sharma, U. (2017) “Traditional Knowledge: A Perfect Guide for the Discovery of Novel Bioactive Molecules” in Seventh Euro-India International Conference on Holistic Medicine (ICHM-2017), Kottayam, Kerala, India, September 15-17.

Sharma, U. (2017) “Future Affordable Medicines: Efforts Towards Novel Bioactive Molecules” in Multidisciplinary National Conference on Innovative Trends in Science, Technology and Management-IV, Organised by Sri Sai University, Palampur, Himachal Pradesh, August 24.

Singh, A. (2017) “Potential of cultivation of medicinal and aromatic plants of cold desert area and future scope” were delivered to the trainees of District Institute of education and Training Tandi, Lahaul-Spiti, No. of Participants more than 80 school Science TGT & PGT teachers, October 28.

Singh, A. (2017) “Climate change effect and literature,” organized by *Azaad Janjatiye Dharohar Suraksha Samiti* venue at Dev Sadan Bhavan Kullu, No. of Participants more than 120 (Chief Guest DC Kullu), December 12.

Singh, A. (2017) “Improving health and sustainable development of Himalayan Region” organized by DRDO-DIHAR Leh, Seabuckthorn Association of India, and Ladakh Autonomous Hill Development Council Leh, September 22-24.

Singh, A. (2017) “Cultivation potential of medicinal and aromatic plants in the Lahaul valley a cold desert area”, on the occasion of Kisan Mela topic *Paudha Kisam Aur Adhikar*

*Sanrakshan Adhiniyam 2001* at KVK Kukumseri, Lahaul- Spiti, No. of Participants farmers 118, September 15.

Singh, A. (2017) “Cultivation of Medicinal and Aromatic plants of Lahaul Spiti and their future scope” at Keylong Lahaul-Spiti, No of Participants more than 100 Panchayat members, June 26.

Singh, A. (2017) “*Jevik Paramparagat Krisi Fasal by NGO Youth for Sustainable Development*” at Tuphiling Gompa-Tandi Lahaul-Spiti (H.P.), No. of participants more than 1200, September 2.

Singh, D. (2018) Delivered an invited talk on “Novel targets for the management of epilepsy: Focus on therapeutic switching” in 10<sup>th</sup> NIPER-Symposium “Nano Based Therapy for Neurodegenerative Diseases” at NIPER, Raebareli, March 28.

Sud, RK. (2017) Conservation of rare, endangered and threatened medicinal plants, with special reference to nagchhatri. Visit of farmers from high altitude (HP), May 31.

Sud, RK. (2017) Prospects of tea in Himachal Pradesh In: National seminar cum buyer seller meet on tea production, processing and marketing, CSKHPKV Palampur, August 4-5.

Sud, RK. (2017) Role of CSIR-IHBT in revival of Kangra tea and its future plans. In: Workshop on Kangra Tea Industry, Current status and future prospects. In: Kangra tea industry meet, Palampur, August 31.

Sud, RK. (2018) Agrotechnologies for West Bengal with special reference to Darjeeling. In West Bengal Agricultural Directorate Expert Meet, March 21.

## **VISITS ABROAD**

Amit Kumar visited Italy to attend training on “LiDAR System for Remote Sensing” at 3D TARGET SRL, Brescia, Italy, 3-7 July, 2017.

Rakesh Kumar visited Japan to attend conference on Smart Agriculture for Sustainable, Inclusive Productivity in Tokyo, Japan, 5-7 September, 2017.

Gireesh Nadda visited Addis Ababa, Ethiopia as a part of delegation of His Excellency Shri Ram Nath Kobind, President of the Republic of India from October 4-9, 2017.

## **DISTINGUISHED VISITORS**

Mr. Ronald Sapa Tlau, Member Parliament, Mizoram, June 22 2017.

Mrs. Renuka Chowdhury, Member Parliament and Chairperson Parliament Standing Committee of Science and Technology, Forest and Environment, Govt. of India, June 23, 2017.

Dr. Anil Kush, Chairman, Research Council, CSIR-IHBT and Chief Executive Officer, Vittal Mallya Scientific Research Foundation, Bangalore, November 25, 2017.

Mr. Anand R. Chordia, Member, Research Council, CSIR-IHBT and Director (Technical), Pravin Masalewale, Pune (Maharashtra), November 25, 2017.

Dr. SK Barik, Member, Research Council, CSIR-IHBT and Director, CSIR-NBRI, Lucknow, November 25, 2017.

Dr. Ram Lal Markanda, Agriculture, IT and Tribal Development Minister, H.P., January 29, 2018.

Mrs. Sarveen Chaudhary, Urban Development, TCP & Housing Minister, H.P., March 23, 2018.

## POSTER PRESENTED

Dhiman, A.K., Chaudhary, S., Kumar, R., Kumar, R., and Sharma U. (2017) Synthesis of 2-substituted-3-(2-hydroxyaryl) quinolines and 4-(2-hydroxyaryl) acridines. in Contemporary Facets in Organic Chemistry Synthesis (CFOS) 2017, IIT Roorkee, Uttarakhand, December 22-24.

Sharma, R., Kumar, R., Kumar, I., and Sharma, U. (2017)  $[Cp^*RhCl_2]_2$  catalyzed remote functionalization of quinolines and their mechanistic understanding. Indo-US bilateral workshop organised by IISc Bangalore, IISER Kolkata and IIT Mumbai at rhythm Lonavala, Lonavala, Maharashtra, India, December 7-10.

Kumar, R., Dhiman, A.K., and Sharma, U. (2017) Metal-free C-2 arylation of quinoline *N*-oxides with aryldiazonium salts/anilines. 21<sup>st</sup> CRSI National Symposium in Chemistry organised by CSIR-IICT, Tarnaka Hyderabad.

Sharma, R., Kumar, I., Kumar, R., and Sharma, U. (2017) Rhodium (III)-catalyzed remote c-h activation/functionalization of quinolines. 21<sup>st</sup> CRSI National Symposium in Chemistry organised by CSIR-IICT, Tarnaka Hyderabad.

Thakur, D. (2017) Poster Presented in “2<sup>nd</sup> Himachal Pradesh Science Congress” organised by HIMCOSTE, Shimla, November 20-21.

Thakur, M., and Kumar, R. (2017) Microclimate modification effect on growth and essential oil content of damask rose (*Rosa damascena*) in the western Himalayas. Oral presentation in 2<sup>nd</sup> Himachal science Congress, Shimla, November 20-21.

Walia, S Saini, K., Sud R. K. and Kumar R. (2017) *Tagetes minuta* L.: A potential aromatic crop for enhancing farmers' income of the hilly states. 2<sup>nd</sup> Himachal science Congress. Shimla, November 20-21.

## PARTICIPATION IN EXHIBITION

Dr. Gireesh Nadda. Exhibited the R&D activities of CSIR-India including activities and products of CSIR-IHBT at Addis Ababa-Ethiopia as a part of delegation of President of the Republic of India. His Excellency Shri Ram Nath Kobind, President of the Republic of India and His Excellency Dr. Mulatu Teshome, President of the Federal Democratic Republic of Ethiopia, visited CSIR-IHBT stall and interacted with team. There was B2B meet wherein many industrialists and businessman visited and interacted with team. October 5-7, 2018.

Aroma Mission activities were exhibited at Aizawl Mizoram on the occasion of the visit of Hon'ble Prime Minister of India. The directors of CSIR-IHBT and CSIR-NEIST as well as other scientists participated in this activity of portraying technologies relevant to north-eastern regions of the country, 16 December.



Showcasing of Aroma Mission activities in North-East Mizoram on 16-12-2017

## RADIO TALK

Dr Rakesh Kumar (2018) “Cultivation of Aromatic Plants under CSIR-Aroma project” on Community Radio Mukteshwar, Uttarakhand, 16 March which was aired on 22 March.

## PRIZES/AWARDS/RECOGNITIONS

Lal, B. (2017) Elected as a Member of the Executive Council of the Society of Ethnobotanists. Lucknow for the year 2014-2017.

Lal, B. (2017) Nominated as Member of the ‘*Project Approval Committee (PAC)*’ by H.P. Council for Science, Technology & Environment (HIMCOSTE), Shimla.

Lal, B. (2017) Member of Editorial Board of the quarterly journal, ‘Indian Journal of Natural Products and Resources’ published by CSIR-NISCIAR New Delhi, for the period of two years (1<sup>st</sup> January 2015-31<sup>st</sup> December 2017).

Sanjay Kumar Uniyal invited as an expert in botany in the 12<sup>th</sup> Uttarakhand State Science and Technology Congress 2017-18 held at Dehradun, March 07-09, 2018.

Amita Bhattacharya (2018) Invited to sever as member of the DBT task force for Value Added Biomass and Production from Natural Resources w.e.f. March.

Rakesh Kumar was awarded travel grant by Asian Productivity Organization, Tokyo, Japan to attend the conference on Smart Agriculture for Sustainable, Inclusive Productivity in Tokyo, Japan from September 5-7, 2017.

Rakesh Kumar was nominated as expert member for on the spot Assessment/Discussion for 2<sup>nd</sup> Phase/next Phase of Core Support to non-governmental organizations (NGOs) by DST, GOI, New Delhi.

Amita Bhattacharya was invited to sever as member of the DBT task force for Value Added Biomass and Production from Natural Resources w.e.f. March, 2018.

Mahesh Gupta, Pallavi Sharma, Arindam G. Mazumder, Vikram Patial, Damanpreet Singh received best paper award “Dwindling of cardio damaging effect of isoproterenol by *Punica granatum* L. peel extract involve activation of nitric oxide-mediated Nrf2/ARE signaling pathway and apoptosis inhibition”. Nitric Oxide, Indian pharmacological society at IPSCON, Mumbai, 2017.

Arindam G. Mazumder, Pallavi Sharma, Vikram Patial, Damanpreet Singh received best paper award “Crocic Attenuates Kindling Development and Associated Cognitive Impairments in Mice via Inhibiting Reactive Oxygen Species-Mediated NF- $\kappa$ B Activation”. Basic Clinical Pharmacology and Toxicology, Indian pharmacological society at IPSCON, 2017.

Pallavi Sharma, Supriya Sharma and Damanpreet Singh received best paper award “investigating the effect of 4’, 5, 7-Trihydroxyflavone in seizure-induced depression”. National Conference on “Chronic Ailments & Ayurveda” at Ayurvedic College Paprola, 2017.

Staffs





## STAFFS

### Director

Dr. Sanjay Kumar  
Director, CSIR- IGIB (Additional Charge)  
(03.11.2016 to 25.10.2017)  
Head, HRDG (Additional Charge)  
(22.03.2018 Continuing)

### Sr. Principal Scientist

Dr. Ashu Gulati  
Dr. Brij Lal  
Dr. R.K. Sud  
Er. K.K. Singh  
Dr. Aparna Maitra  
Dr. Amita Bhattacharya

### Principal Scientist

Dr. S.K. Vats  
Dr. Vipin Hallan  
Dr. Sanjay Kumar Uniyal  
Dr. Ram Kumar Sharma  
Er. Amit Kumar  
Dr. Sanat Sujat Singh  
Dr. Rakesh Kumar

### Senior Scientist

Dr. Shashi Bhushan  
Dr. Pralay Das  
Dr. Girish Nadda  
Dr. Vijay Kant Agnihotri  
Dr. Ravi Shankar  
Dr. Probir Kumar Pal  
Dr. Rituraj Purohit  
Dr. Sushil Kumar Maurya  
Dr. Dharam Singh  
Dr. Sapan Kumar  
Dr. Pamita Bhandari

### Scientist

Er. Mohit Sharma  
Dr. Amit Chawla  
Dr. Ashok Kumar  
Dr. S.G.E. Reddy  
Dr. Mahesh Gupta  
Dr. Y.S. Padwad  
Dr. Dinesh Kumar  
Dr. Amitabha Acharya  
Dr. Vikram Patial  
Dr. Manoj Kumar  
Dr. Damanpreet Singh  
Dr. Vishal Acharya  
Dr. Ashok Singh  
Dr. Upendra Sharma  
Dr. Bhavya Bhargava  
Dr. Kunal Singh  
Dr. Ashish Rambhau Warghat  
Dr. Rajiv Kumar  
Dr. Narender Vijay Tirpude  
Dr. Rakshak Kumar  
Dr. S. Vidyashankar

### Principal Technical Officer

Sh. Mukhtiar Singh  
Sh. Om Prakash

### Senior Technical Officer (3)

Sh. Sukhjinder Singh

### Senior Technical Officer (2)

Dr. Robin Joshi  
Dr. Kiran Devi  
Sh. Vikrant Gautam  
Dr. Avnesh Kumari  
Sh. Ramdeen Prasad  
Sh. Jitender Bisht

Sh. Jai Prakash Dwivedi

Dr. Kiran Singh Saini

**Senior Technical Officer (1)**

Sh. Rakesh Verma

Sh. Anil Kumar

Sh. Shiv Kumar

Dr. Rajneesh

Dr. Kulurkar Pankaj Markand

Sh. Ramjee Lal Meena

Sh. Vivesh Sood

Sh. Mahesh S.

Sh. Bijan Bihari Garnayak

Sh. Mohit Kumar Swarankar

Sh. Jasbeer Singh

Sh. Mukesh Gautam

Sh. Om Prakash

Sh. Ashok Gehlot

Sh. Kunjan Saxena

**Technical Officer**

Smt. Vijaylata Pathania

Sh. Pabitra Gain

Sh. Aman Kumar

Smt. Meenakshi

Sh. Anil Chaudhary

Sh. Dharmesh Kumar

**Technical Assistant**

Sh. Arvind Kumar Verma

Sh. Pawan Kumar

Smt. Rimpay Dhiman

Sh. Virat Abhishek

Sh. Saurabh Sharma

**Senior Technician (2)**

Sh. Karandeep Sood

Sh. Dharuv Kumar

Sh. Ajay Parmar

**Senior Technician (1)**

Sh. Ramesh Kumar

Sh. Kuldip Singh

Sh. Parveen Kumar

**Technician (2)**

Sh. Sanjay Kumar

Sh. Avinash Chander Rana

Sh. Sandeep Sood

Sh. Ranjeet Singh

Sh. Ajay Kumar

Sh. Surjeet Singh

Sh. Arvind Kant

Smt. Jasveer Kaur

Sh. Vikas Kumar

**Technician (1)**

Sh. Sanjeev Kumar

Sh. Sanjeet Kumar

Sh. Monu Kumar

Sh. Parvinder Kumar

Sh. Ishwar Dass

**Lab. Assistant**

Sh. Amar Singh

**Lab. Attendant (2)**

Smt. Rajni Devi Chetri

Mrs. Anupama Saini

Sh. Shamsheer Singh

Sh. Girjanand

Sh. Baldev Singh

Sh. Kuldeep Singh

Sh. Balwant Raj

Sh. Deepak Sood

**Lab. Attendant (1)**

Sh. Rakesh Chand

Sh. Balak Ram

Sh. Uttam Chand

**Administration Officer**

Sh. Alok Sharma

**Controller of Store and Purchase**

Sh. Suresh Pant

**Section Officer (Gen.)**

Sh. S.D. Rishi

Sh. Amar Jeet

**Section Officer (F&A)**

Sh. Darshan Singh

**Sr. Steno (MACP)**

Sh. Didar Singh Patial

**Hindi Translator**

Sh. Sanjay Kumar

**Assistant Section Officer**

Sh. Raj Kumar

Sh. Parveen Singh

Sh. Ved Prakash

Sh. Keerti Raj

Smt. Santosh Kumari

Sh. Baldev

**Assistant Section Officer (F&A)**

Sh. Manoj Kumar

Sh. Vipin Kumar

Smt. Aruna Kumari

**Assistant Section Officer (S&P)**

Sh. Rajeev Sood

**Senior Secretariat Assistant**

Sh. Kiran Kumar

Smt. Pooja Awasthi

**Junior Secretariat Assistant (S&P)**

Sh. Rajinder Singh

**Junior Secretariat Assistant**

Sh. Praveen Kumar

Sh. Sandeep Kumar

Sh. Mukul Sharma

Sh. Ajay Singh Kaundal

**Junior Stenographer**

Sh. Boni Kumar

**Security Assistant**

Sh. Trilok Nath

**Coupon Clerk**

Sh. Anand Sharma

**Cook**

Sh. Oman Singh

Sh. Karan Singh

**Driver**

Sh. Partap Chand

Sh. Braham Dass

Sh. Lakhvinder Singh

Sh. Nitesh Bhardwaj

**Waiter**

Sh. Bipan Kumar

**Wash Boy**

Sh. Shankar

**Gr. "C" (Non- Technical)**

Sh. Thaman Bahadur

**Chowkidar**

Sh. Baleshwar Prasad

Sh. Devender Kumar

**Tea Maker**

Sh. Bipan Gurang

**Frash**

Smt. Rujala Devi

**Staff Joined CSIR-IHBT between 01.04.2017-31.03.2018**

<b>Sr. No.</b>	<b>Name</b>	<b>Designation</b>	<b>Date of Joining</b>
1.	Sh. Boni Kumar	Junior Stenographer	28.06.2017
2.	Sh. Sanjeet Kumar	Technician (1)	14.07.2017
3.	Sh. Sanjeev Kumar	Technician (1)	14.07.2017
4.	Sh. Monu Kumar	Technician (1)	14.07.2017
5.	Sh. Parvinder Kumar	Technician (1)	20.07.2017
6.	Sh. Ishwar Dass	Technician (1)	27.07.2017
7.	Dr. Rakshak Kumar	Scientist	07.08.2017
8.	Dr. Sapan Kumar	Sr. Scientist	10.08.2017
9.	Dr. Pamita Bhandari	Sr. Scientist	04.09.2017
10.	Dr. S. Vidyashankar	Scientist	15.09.2017

### Staff Superannuated



**Dr. Bikram Singh**  
Chief Scientist,  
30.04.2017



**Sh. V. S. Dadhwal**  
Senior Technician (2),  
31.07.2017



**Sh. Kuldeep Singh**  
Multi Tasking Staff,  
31.08.2017



**Sh. R.S. Shekhawat**  
Senior Technical Officer (3),  
30.11.2017



**Dr. Gopichand**  
Senior Principal Scientist,  
31.12.2017

## EMERITUS SCIENTISTS/SCIENTIST FELLOWS/RESEARCH SCHOLARS

### Emeritus Scientists

Dr. Shyam Kumar Sharma

Dr. Arvind Gulati

### Scientists Fellow

Dr. Ugir Hossain SK

Dr. Ajay Rana

Dr. Tanuja Rana

### TWAS- Fellow

Ms. Adenike Evelyn Adeniyi

Mr. Tony Kipkoech Maritim

### Inspire Faculty

Dr. Rohit Sharma

### DST-Young Scientist

Dr. Jyoti Bhardwaj

### NPDF

Dr. Ashun Chaudhary

Mr. Praveen Dhyani

Mr. Vijay Kumar

Dr. Paromik Bhattacharyya

Dr. Simmi Sharma

Mr. Archit Sood

Dr. Pankaj Kumar

### NPDF/SERB

Ms. Prakriti Kashyap

### Research Associate

Dr. Dipika Rana

Dr. Rachit R Kashyap

Dr. Virender Kumar

Ms. Priyanka Sati

Dr. Umesh Pankaj

### SRF

Ms. Isha Sharma

Mr. Bhuvnesh Sareen

Mr. Ganesh Prabhakar Panjade

Mr. Dinesh Thakur

Mr. Saurabh Soni

Mr. Roushan Kumar

Mr. Maheshwar Singh Thakur

Ms. Tanvi Sharma

Ms. Nisha Dhiman

Mr. Arindam G. Majumdar

Mr. Rakesh Kumar

Mr. Gopal Singh

Ms. Shaifali

Ms. Namo Dubey

Ms. Sunil Kumar

Ms. Shanka Walia

Ms. Ritika Sharma

Ms. Rajni Parmar

Mr. Dhananjay Bhattacharjee

Ms. Nikita Rathore

### JRF

Ms. Shweta Guleria

Mr. Rohit Rana

Mr. Lakhbeer Singh

Ms. Sanyukta Darnal

Mr. Shankar Ram

Mr. Subhash Kumar

Mr. Sachin Kumar

Ms. Jyoti Devi

Mr. Shiv Rattan

Ms. Priyanka Dhaka

Ms. Jyoti Chhimwal

Mr. Ram Chander

Mr. Syed Muruza Sayeed Ali

Mr. Anil Kumar Rana

Ms. Ambika  
Mr. Mahinder Partap  
Ms. Nang Elennie Hopak  
Ms. Chandni Sharma  
Mr. Ashish Kumar Shukla  
Ms. Ashrita  
Mr. Virender Kumar  
Ms. Poonam Pal  
Ms. Kanchan Yadav  
Ms. Shruti Sinai Borker  
Ms. Manglesh Kumari  
Mr. Prince Anand  
Ms. Arti Sharma  
Ms. Bipasha Bhattacharjee  
Ms. Kajal Sinha  
Mr. Neeraj Kumar  
Ms. Sheetal  
Mr. Bittu Ram  
Mr. Anil Kumar  
Ms. Samita Kapoor

Ms. Neha Baliyan  
Mr. Patil Shivprasad Suresh  
**Research Fellow**  
Mr. Romit Seth  
Mr. Sourav Kumar  
**Research Assistant**  
Ms. Pallavi Sharma  
**Project Fellow**  
Mr. Mustakim Ahmed  
Ms. Alpy  
Ms. Anamika Sharma  
Mr. Ankit K Dhiman  
Mr. Anupam Bhatt  
Ms. Deepika Devi  
Mr. Rahul Upadhayay  
Ms. Srijana Mukhia  
Ms. Savita Kumari  
Ms. Rashim Kumari  
**Project Assistant-II**  
Ms. Anju Singh





## News Clippings of CSIR-IHBT





अवसर आईएचबीटी पालमपुर में कौशल विकास कार्यक्रम आरंभ

स्वरोजगार के अवसर बढ़ाने का मौक...
स्वरोजगार के अवसर बढ़ाने का मौक...
स्वरोजगार के अवसर बढ़ाने का मौक...

छात्रों ने जानी विज्ञान की बारीकियां

पालमपुर सीएसआईआर संस्थान में प्लेटिनम जुबली टेक्नोफेस्ट का आगाज...
पालमपुर सीएसआईआर संस्थान में प्लेटिनम जुबली टेक्नोफेस्ट का आगाज...

भाजपा विजन डॉक्यूमेंट कमेटी ने पालमपुर में लिए सुझाव

राज्य सरकार, भाजपा - उद्यम धारा की विजन डॉक्यूमेंट कमेटी ने पालमपुर में विभिन्न संस्थाओं के प्रतिनिधियों के साथ बैठक में भाजपा विजन डॉक्यूमेंट कमेटी ने पालमपुर में लिए सुझाव...
राज्य सरकार, भाजपा - उद्यम धारा की विजन डॉक्यूमेंट कमेटी ने पालमपुर में विभिन्न संस्थाओं के प्रतिनिधियों के साथ बैठक में भाजपा विजन डॉक्यूमेंट कमेटी ने पालमपुर में लिए सुझाव...

सीएसआईआर की प्लेटिनम जुबली पर लगेगी प्रदर्शनी

पालमपुर। सीएसआईआर (वैज्ञानिक तथा औद्योगिक)

लो जनाब! अब आलू करेगा मालामाल

शुगर कर्षकों से लेकर किसानों तक, आलू का उत्पादन, निर्यात और खपत में बढ़ावा देना...
शुगर कर्षकों से लेकर किसानों तक, आलू का उत्पादन, निर्यात और खपत में बढ़ावा देना...

टी वाइन पीएं, खुलकर जिएं

टी वाइन पीएं, खुलकर जिएं...
टी वाइन पीएं, खुलकर जिएं...

पालमपुर में मिलेगा साइंस का हर जवाब

पालमपुर में मिलेगा साइंस का हर जवाब...
पालमपुर में मिलेगा साइंस का हर जवाब...

विज्ञान की खोजों के बारे में जानें नौनिहाल : शांता सांसद ने पालमपुर में किया डेस्टिनेशन-2017 का शुभारंभ

शांता सांसद ने पालमपुर में किया डेस्टिनेशन-2017 का शुभारंभ...
शांता सांसद ने पालमपुर में किया डेस्टिनेशन-2017 का शुभारंभ...

पौधों और जड़ी-बूटियों पर लोगों की जागरूकता जरूरी

पौधों और जड़ी-बूटियों पर लोगों की जागरूकता जरूरी...
पौधों और जड़ी-बूटियों पर लोगों की जागरूकता जरूरी...

आलू की टिप्स कल्चर तकनीक से खुशहाल होंगे सब के किसान

आलू की टिप्स कल्चर तकनीक से खुशहाल होंगे सब के किसान...
आलू की टिप्स कल्चर तकनीक से खुशहाल होंगे सब के किसान...

जड़ी-बूटियों की जानकारी के लिए बने एप

जड़ी-बूटियों की जानकारी के लिए बने एप...
जड़ी-बूटियों की जानकारी के लिए बने एप...

सीएसआईआर और धानाधार बायोलाइट में समझौता

सीएसआईआर और धानाधार बायोलाइट में समझौता...
सीएसआईआर और धानाधार बायोलाइट में समझौता...

शांता कुमार ने डेस्टिनेशन 2017 का किया शुभारंभ

शांता कुमार ने डेस्टिनेशन 2017 का किया शुभारंभ...
शांता कुमार ने डेस्टिनेशन 2017 का किया शुभारंभ...

विकसित की फूलों की पांच क्रिमें

विकसित की फूलों की पांच क्रिमें...
विकसित की फूलों की पांच क्रिमें...

शुगर के मरीज शौक से खाएं मीठा

शुगर के मरीज शौक से खाएं मीठा...
शुगर के मरीज शौक से खाएं मीठा...

शुगर-बीपी से बचाएंगी 'स्टीविया' की मिठास

शुगर-बीपी से बचाएंगी 'स्टीविया' की मिठास...
शुगर-बीपी से बचाएंगी 'स्टीविया' की मिठास...

हिम-घोर तरल स्टीविया से मिलेगी राहत

हिम-घोर तरल स्टीविया से मिलेगी राहत...
हिम-घोर तरल स्टीविया से मिलेगी राहत...

सया हे स्टीविया

सया हे स्टीविया...
सया हे स्टीविया...

कार्यक्रम स्थापना दिवस पर सम्मानित किए किसान और कर्मचारी

कार्यक्रम स्थापना दिवस पर सम्मानित किए किसान और कर्मचारी...
कार्यक्रम स्थापना दिवस पर सम्मानित किए किसान और कर्मचारी...

सीएसआईआर ने मनाया 76वां स्थापना दिवस

सीएसआईआर ने मनाया 76वां स्थापना दिवस...
सीएसआईआर ने मनाया 76वां स्थापना दिवस...

शुगर के मरीज शौक से खाएं मीठा

शुगर के मरीज शौक से खाएं मीठा...
शुगर के मरीज शौक से खाएं मीठा...







परिकल्पना : हिमालय जैवसंपदा के सतत् उपयोग द्वारा जैवआर्थिकी के उन्नयन हेतु  
प्रौद्योगिकी विकास में वैश्विक नेतृत्व अर्जन

Vision : To be a global leader on technologies for boosting bioeconomy  
through sustainable utilization of Himalayan bioresources



सीएसआईआर-हिमालय जैवसंपदा प्रौद्योगिकी संस्थान  
CSIR-Institute of Himalayan Bioresource Technology  
पालमपुर-हिमाचल प्रदेश / Palampur-Himachal Pradesh